

***Absorbed Dose Determination in
External Beam Radiotherapy:
An International Code of Practice for Dosimetry
based on Standards of Absorbed Dose to Water***

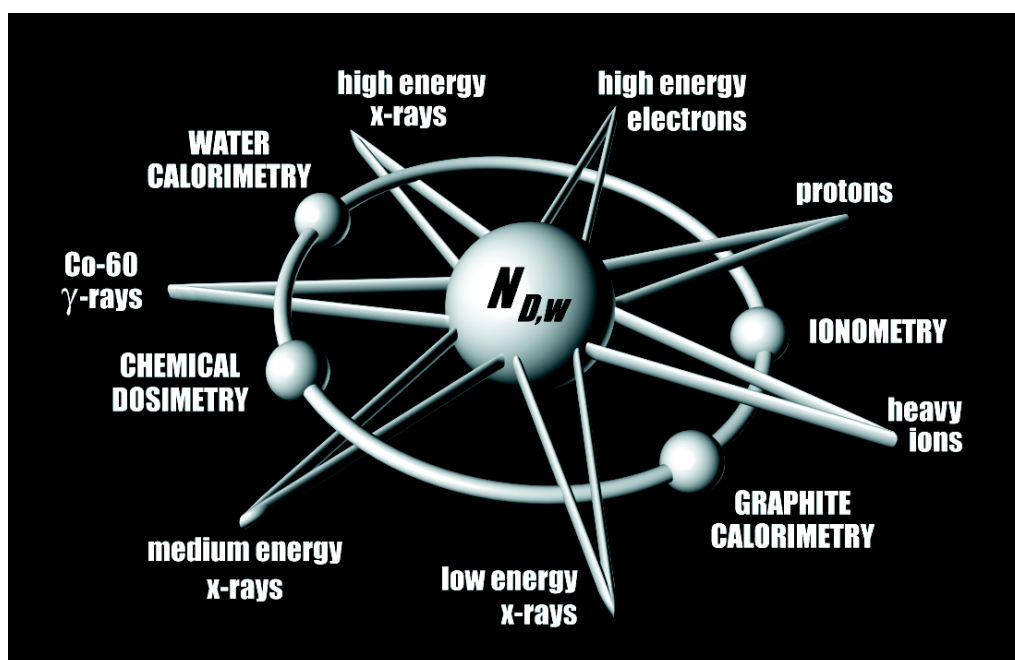

Pedro Andreo, Dosimetry and Medical Radiation Physics Section, IAEA

David T Burns, Bureau International des Poids et Mesures (BIPM)

Klaus Hohlfeld, Physikalisch-Technische Bundesanstalt (PTB), Braunschweig, Germany

M Saiful Huq, Thomas Jefferson University, Philadelphia, USA

Tatsuaki Kanai, National Institute of Radiological Sciences (NIRS), Chiba, Japan

Fedele Laitano, Ente per le Nuove Tecnologie L'Energia e L'Ambiente (ENEA), Rome, Italy

Vere Smyth, National Radiation Laboratory (NRL), Christchurch, New Zealand

Stefaan Vynckier, Catholic University of Louvain (UCL), Brussels, Belgium

PUBLISHED BY THE IAEA ON BEHALF OF IAEA, WHO, PAHO, AND ESTRO



INTERNATIONAL ATOMIC ENERGY AGENCY **IAEA**

21 May 2001 (V.10A)

The originating Section of this publication in the IAEA was:

Dosimetry and Medical Radiation Physics Section
International Atomic Energy Agency
Wagramer Strasse 5
P.O. Box 100
A-1400 Vienna, Austria

ABSORBED DOSE DETERMINATION IN EXTERNAL BEAM RADIOTHERAPY:
AN INTERNATIONAL CODE OF PRACTICE FOR DOSIMETRY
BASED ON STANDARDS OF ABSORBED DOSE TO WATER
IAEA, VIENNA, 2000
ISSN 1011-4289

© IAEA, 2000

Printed by the IAEA in Austria
2000

FOREWORD

The International Atomic Energy Agency published in 1987 an International Code of Practice entitled *Absorbed Dose Determination in Photon and Electron Beams* (IAEA Technical Reports Series No. 277), recommending procedures to obtain the absorbed dose in water from measurements made with an ionization chamber in external beam radiotherapy. A second edition of TRS-277 was published in 1997 updating the dosimetry of photon beams, mainly kilovoltage x-rays. Another International Code of Practice for radiotherapy dosimetry entitled *The Use of Plane-Parallel Ionization Chambers in High-Energy Electron and Photon Beams* (IAEA Technical Reports Series No. 381) was published in 1997 to further update TRS-277 and complement it with respect to the area of parallel-plate ionization chambers. Both codes have proven extremely valuable for users involved in the dosimetry of the radiation beams used in radiotherapy. In TRS-277 the calibration of the ionization chambers was based on primary standards of air kerma; this procedure was also used in TRS-381, but the new trend of calibrating ionization chambers directly in a water phantom in terms of absorbed dose to water was introduced.

The development of primary standards of absorbed dose to water for high-energy photon and electron beams, and improvements in radiation dosimetry concepts, offer the possibility of reducing the uncertainty in the dosimetry of radiotherapy beams. The dosimetry of kilovoltage x-rays, as well as that of proton and heavy-ion beams whose interest has grown considerably in recent years, can also be based on these standards. Thus a coherent dosimetry system based on standards of absorbed dose to water is possible for practically all radiotherapy beams. Many Primary Standard Dosimetry Laboratories (PSDLs) already provide calibrations in terms of absorbed dose to water at the radiation quality of ^{60}Co gamma-rays. Some laboratories have extended calibrations to high-energy photon and electron beams or are in the stage of developing the necessary techniques for these modalities.

Following the recommendations in 1996 of the IAEA Standing Advisory Group “Scientific Committee of the IAEA/WHO SSDL Network”, a Co-ordinated Research Project was undertaken during 1997-1999 with the task of producing a new International Code of Practice based on standards of absorbed dose to water. The group of authors were P Andreo (IAEA), D T Burns (BIPM), K Hohlfeld (Germany), M S Huq (USA), T Kanai (Japan), F Laitano (Italy), V G Smyth (New Zealand) and S Vynckier (Belgium). The Code of Practice is also endorsed by the World Health Organization (WHO), by the Pan American Health Organization (PAHO), and by the European Society of Therapeutic Radiology and Oncology (ESTRO). The final draft was reviewed by representatives of the organizations endorsing the Code of Practice and by a large number of scientists whose names are given in the list of contributors.

The present Code of Practice fulfils the need for a systematic and internationally unified approach to the calibration of ionization chambers in terms of absorbed dose to water and to the use of these detectors in determining the absorbed dose to water for the radiation beams used in radiotherapy. The Code of Practice provides a methodology for the determination of absorbed dose to water in the low-, medium- and high-energy photon beams, electron beams, proton beams and heavy-ion beams used for external radiation therapy. The structure of this Code of Practice differs from TRS-277 and more closely resembles TRS-381 in that the practical recommendations and data for each radiation type have been placed in an individual section devoted to that radiation type. Each essentially forms a different Code of Practice including detailed procedures and worksheets.

The Code of Practice is addressed to users provided with calibrations in terms of absorbed dose to water traceable to a PSDL. This category of users is likely to become the large majority since most standard laboratories are prepared or are planning to supply calibrations in terms of absorbed dose to water at the reference radiation qualities recommended in this Code of Practice. Users who are not yet provided with calibrations in terms of absorbed dose to water, may still refer to the current air-kerma based Codes of Practice, such as TRS-277 (2nd edition, 1997) and TRS-381, or adopt the present document using a calibration factor in terms of absorbed dose to water derived from an air kerma calibration as described in the text. Whatever procedure be used, the user is strongly advised to verify

exactly what physical quantity has been used for the calibration of the reference dosimeter in order to apply the correct formalism.

Every user is invited to test critically the present edition of the International Code of Practice and submit comments to:

Head, Dosimetry and Medical Radiation Physics Section
Division of Human Health
International Atomic Energy Agency,
P.O. Box 100, A-1400 Vienna, Austria

e-mail: dosimetry@iaea.org
fax: +43 1 26007

EDITORIAL NOTE

In preparing this publication for press, staff of the IAEA have made up the pages from the original manuscript(s). The views expressed do not necessarily reflect those of the IAEA, the governments of the nominating Member States or the nominating organizations.

Throughout the text names of Member States are retained as they were when the text was compiled.

The use of particular designations of countries or territories does not imply any judgement by the publisher, the IAEA, as to the legal status of such countries or territories, of their authorities and institutions or of the delimitation of their boundaries.

The mention of names of specific companies or products (whether or not indicated as registered) does not imply any intention to infringe proprietary rights, nor should it be construed as an endorsement or recommendation on the part of the IAEA.

AUTHORS

P. Andreo	International Atomic Energy Agency (IAEA)
D. T. Burns	Bureau International des Poids et Measures (BIPM)
K. Hohlfeld	Physikalisch-Technische Bundesanstalt (PTB), Braunschweig, Germany
M. S. Huq	Thomas Jefferson University, Kimmel Cancer Center of Jefferson Medical College Philadelphia, PA, USA
T. Kanai	National Institute of Radiological Sciences (NIRS), Chiba, Japan
F. Laitano	Ente per le Nuove Tecnologie L'Energia e L'Ambiente (ENEA), Istituto Nazionale di Metrologia delle Radiazioni Ionizzanti, Rome, Italy
V. G. Smyth	National Radiation Laboratory (NRL), Christchurch, New Zealand
S. Vynckier	Catholic University of Louvain (UCL), Cliniques Universitaires St-Luc Brussels, Belgium

The organizations endorsing this International Code of Practice (IAEA, WHO, PAHO and ESTRO) wish to acknowledge valuable suggestions and criticism from

P Allisy-Roberts (BIPM)	S Belletti (ITA)	H Bjerke (NOR)
J F Boas (AUS)	A Bridier (FRA)	A Brosed (ESP)
M Bucciolini (ITA)	J E Burns (GBR)	J Chavaudra (FRA)
F Delaunay (FRA)	L A DeWerd (USA)	S Duane (GBR)
A DuSautoy (GBR)	I Ferreira (FRA)	C Ginestet (FRA)
J E Grindborg (SWE)	A Guerra (ITA)	G Hartmann (DEU)
R B Huntley (AUS)	H Järvinen (FIN)	K-A Johansson (SWE)
L H Kotler (AUS)	S Lassen (DNK)	L Lindborg (SWE)
C Ma (USA)	G Marinello (FRA)	O Mattsson (SWE)
M McEwen (GBR)	J Medin (SWE)	C Moretti (GBR)
B Mijneer (NLD, for ESTRO)	R M Millar (AUS)	P S Negi (IND)
B Nilsson (SWE)	H Nyström (DNK)	H Palmans (BEL)
A Palm (SWE)	M Pimpinella (ITA)	M M Rehani (IND, for WHO)
K Rosser (GBR)	R Sabattier (FRA)	R J Schulz (USA, for PAHO)
G Sernbo (SWE)	J Seuntjens (CAN)	K Shortt (CAN)
G Stucki (CHE)	H Svensson (SWE, for ESTRO)	J Van Dam (BEL)
D V Webb (AUS)		

CONTENTS

1.	INTRODUCTION	13
1.1.	Background	13
1.2.	Advantages of a Code of Practice based on standards of absorbed dose to water.....	15
1.2.1.	Reduced uncertainty.....	15
1.2.2.	A more robust system of primary standards	16
1.2.3.	Use of a simple formalism	17
1.3.	Types of radiation and range of beam qualities	17
1.4.	Practical use of the Code of Practice.....	17
1.5.	Expression of uncertainties	18
1.6.	Quantities and symbols	18
1.7.	List of acronyms	22
2.	FRAMEWORK	23
2.1.	The International Measurement System.....	23
2.1.1.	The IAEA/WHO network of SSDLs.....	23
2.2.	Standards of absorbed dose to water	24
3.	$N_{D,w}$ -BASED FORMALISM.....	27
3.1.	Formalism.....	27
3.1.1.	Reference conditions.....	27
3.1.2.	Influence quantities	27
3.2.	Correction for the radiation quality of the beam, k_{Q,Q_0}	28
3.2.1.	A modified k_{Q,Q_0} for electron-beam cross calibrations	29
3.3.	Relation to N_K -based Codes of Practice	30
4.	IMPLEMENTATION.....	33
4.1.	General	33
4.2.	Equipment	35
4.2.1.	Ionization chambers	35
4.2.2.	Measuring assembly.....	40
4.2.3.	Phantoms	40
4.2.4.	Waterproof sleeve for the chamber.....	41
4.2.5.	Positioning of ionization chambers at the reference depth	42
4.3.	Calibration of ionization chambers	43
4.3.1.	Calibration in a ^{60}Co beam.....	44
4.3.2.	Calibration in kilovoltage x-rays.....	44
4.3.3.	Calibration at other qualities.....	45
4.4.	Reference dosimetry in the user beam	46
4.4.1.	Determination of the absorbed dose to water	46
4.4.2.	Practical considerations for measurements in the user beam.....	47
4.4.3.	Correction for influence quantities	47
5.	CODE OF PRACTICE FOR COBALT-60 GAMMA RAY BEAMS	53
5.1.	General	53
5.2.	Dosimetry equipment	53
5.2.1.	Ionization chambers	53
5.2.2.	Phantoms and chamber sleeves	53
5.3.	Beam quality specification	54
5.4.	Determination of absorbed dose to water.....	54

5.4.1. Reference conditions.....	54
5.4.2. Determination of absorbed dose under reference conditions.....	54
5.4.3. Absorbed dose at z_{\max}	55
5.5. Cross-calibration of field ionization chambers.....	55
5.6. Measurements under non-reference conditions.....	55
5.6.1. Central-axis depth-dose distributions.....	55
5.6.2. Output factors.....	56
5.7. Estimated uncertainty in the determination of absorbed dose to water under reference conditions.....	56
5.8. Worksheet.....	57
6. CODE OF PRACTICE FOR HIGH-ENERGY PHOTON BEAMS.....	59
6.1. General.....	59
6.2. Dosimetry equipment.....	59
6.2.1. Ionization chambers.....	59
6.2.2. Phantoms and chamber sleeves.....	59
6.3. Beam quality specification.....	60
6.3.1. Choice of beam quality index.....	60
6.3.2. Measurement of beam quality.....	61
6.4. Determination of absorbed dose to water.....	62
6.4.1. Reference conditions.....	62
6.4.2. Determination of absorbed dose under reference conditions.....	62
6.4.3. Absorbed dose at z_{\max}	62
6.5. Values for k_{Q,Q_0}	63
6.5.1. Chamber calibrated in ^{60}Co	63
6.5.2. Chamber calibrated in a series of photon beam qualities.....	66
6.5.3. Chamber calibrated at Q_0 with generic experimental k_{Q,Q_0} values.....	66
6.6. Cross-calibration of field ionization chambers.....	66
6.7. Measurements under non-reference conditions.....	67
6.7.1. Central-axis depth-dose distributions.....	67
6.7.2. Output factors.....	67
6.8. Estimated uncertainty in the determination of absorbed dose to water under reference conditions.....	68
6.9. Worksheet.....	70
7. CODE OF PRACTICE FOR HIGH-ENERGY ELECTRON BEAMS.....	73
7.1. General.....	73
7.2. Dosimetry equipment.....	73
7.2.1. Ionization chambers.....	73
7.2.2. Phantoms and chamber sleeves.....	73
7.3. Beam quality specification.....	74
7.3.1. Choice of beam quality index.....	74
7.3.2. Measurement of beam quality.....	74
7.4. Determination of absorbed dose to water.....	75
7.4.1. Reference conditions.....	75
7.4.2. Determination of absorbed dose under reference conditions.....	76
7.4.3. Absorbed dose at z_{\max}	76
7.5. Values for k_{Q,Q_0}	76
7.5.1. Chamber calibrated in ^{60}Co	76
7.5.2. Chamber calibrated at a series of electron beam qualities.....	78
7.6. Cross-calibration of ionization chambers.....	78
7.6.1. Cross-calibration procedure.....	78
7.6.2. Subsequent use of a cross-calibrated chamber.....	79

7.7.	Measurements under non-reference conditions.....	83
7.7.1.	Central-axis depth-dose distributions	83
7.7.2.	Output factors.....	83
7.8.	Use of plastic phantoms	83
7.8.1.	Scaling of depths	83
7.8.2.	Plastic phantoms for beam quality specification	84
7.8.3.	Plastic phantoms for absorbed dose determination at Z_{ref}	84
7.8.4.	Plastic phantoms for depth-dose distributions	85
7.9.	Estimated uncertainty in the determination of absorbed dose to water under reference conditions	85
7.10.	Worksheet.....	88
8.	CODE OF PRACTICE FOR LOW-ENERGY KILOVOLTAGE X-RAY BEAMS	91
8.1.	General	91
8.2.	Dosimetry equipment	91
8.2.1.	Ionization chambers	91
8.2.2.	Phantoms.....	92
8.3.	Beam quality specification.....	92
8.3.1.	Choice of beam quality index	92
8.3.2.	Measurement of beam quality.....	93
8.4.	Determination of absorbed dose to water.....	94
8.4.1.	Reference conditions.....	94
8.4.2.	Determination of absorbed dose under reference conditions.....	95
8.5.	Values for k_{Q,Q_0}	95
8.6.	Measurements under non-reference conditions.....	96
8.6.1.	Central axis depth-dose distributions.....	96
8.6.2.	Output factors.....	96
8.7.	Estimated uncertainty in the determination of absorbed dose to water under reference conditions	96
8.8.	Worksheet.....	98
9.	CODE OF PRACTICE FOR MEDIUM-ENERGY KILOVOLTAGE X-RAY BEAMS.....	101
9.1.	General	101
9.2.	Dosimetry equipment	101
9.2.1.	Ionization chambers	101
9.2.2.	Phantoms and chamber sleeves.....	102
9.3.	Beam quality specification.....	103
9.3.1.	Choice of beam quality index	103
9.3.2.	Measurement of beam quality.....	104
9.4.	Determination of absorbed dose to water.....	104
9.4.1.	Reference conditions.....	104
9.4.2.	Determination of absorbed dose under reference conditions.....	105
9.5.	Values for k_{Q,Q_0}	105
9.6.	Measurements under non-reference conditions.....	106
9.6.1.	Central axis depth-dose distributions.....	106
9.6.2.	Output factors.....	106
9.7.	Estimated uncertainty in the determination of absorbed dose to water under reference conditions	107
9.8.	Worksheet.....	109
10.	CODE OF PRACTICE FOR PROTON BEAMS.....	111
10.1.	General	111
10.2.	Dosimetry equipment	111

10.2.1. Ionization chambers.....	111
10.2.2. Phantoms and chamber sleeves	113
10.3. Beam quality specification	113
10.3.1. Choice of beam quality index.....	113
10.3.2. Measurement of beam quality	114
10.4. Determination of absorbed dose to water.....	114
10.4.1. Reference conditions	114
10.4.2. Determination of absorbed dose under reference conditions	114
10.5. Values for k_{Q,Q_0}	115
10.6. Measurements under non-reference conditions.....	115
10.6.1. Central-axis depth-dose distributions	115
10.6.2. Output factors	116
10.6.3. Use of plastic phantoms for relative dosimetry.....	119
10.7. Estimated uncertainty in the determination of absorbed dose to water under reference conditions	119
10.8. Worksheet.....	121
11. CODE OF PRACTICE FOR HEAVY-ION BEAMS	123
11.1. General	123
11.2. Dosimetry equipment	125
11.2.1. Ionization chambers.....	125
11.2.2. Phantoms and chamber sleeves	126
11.3. Beam quality specification	126
11.4. Determination of absorbed dose to water.....	126
11.4.1. Reference conditions	126
11.4.2. Determination of absorbed dose under reference conditions	127
11.5. Values for k_{Q,Q_0}	128
11.6. Measurements under non-reference conditions.....	128
11.7. Estimated uncertainty in the determination of absorbed dose to water under reference conditions	130
11.8. Worksheet.....	131
APPENDIX A. RELATION BETWEEN N_K AND $N_{D,w}$ BASED CODES OF PRACTICE	133
A.1. ^{60}Co and high-energy photon and electron beams	133
A.1.1. A summary of notations used for calibration factors	135
A.1.2. Comparison of D_w determinations.....	136
A.2. Kilovoltage x-ray beams	138
APPENDIX B. CALCULATION OF k_{Q,Q_0} AND ITS UNCERTAINTY	139
B.1. General	139
B.2. ^{60}Co gamma radiation.....	139
B.2.1. Value for $s_{w,air}$ in ^{60}Co	139
B.2.2. Value for W_{air} in ^{60}Co	140
B.2.3. Values for p_Q in ^{60}Co	140
B.2.4. Summary of values and uncertainties in ^{60}Co	141
B.3. High-energy photon beams	144
B.3.1. Values for $s_{w,air}$ in high-energy photon beams	144
B.3.2. Value for W_{air} in high-energy photon beams	144
B.3.3. Values for p_Q in high-energy photon beams	144
B.3.4. Summary of uncertainties in high-energy photon beams	145
B.4. Electron beams	146
B.4.1. Values for $s_{w,air}$ in electron beams.....	146
B.4.2. Value for W_{air} in electron beams	147

B.4.3. Values for p_Q in electron beams	147
B.4.4. Summary of uncertainties in electron beams.....	149
B.5. Proton beams.....	150
B.5.1. Values for $s_{w,air}$ in proton beams	150
B.5.2. Value for W_{air} in proton beams	151
B.5.3. Values for p_Q in proton beams	151
B.5.4. Summary of uncertainties in proton beams	152
B.6. Heavy-ion beams.....	152
B.6.1. Value for $s_{w,air}$ in heavy-ion beams	152
B.6.2. Value for W_{air} in heavy-ion beams	153
B.6.3. Value for p_Q in heavy-ion beams	154
B.6.4. Summary of uncertainties in heavy-ion beams.....	154
 APPENDIX C. PHOTON BEAM QUALITY SPECIFICATION.....	 155
C.1. Overview of common photon beam quality specifiers	155
C.2. Advantages and disadvantages of $TPR_{20,10}$	156
C.3. Advantages and disadvantages of $PDD(10)_x$	158
C.4. Concluding remarks	162
 APPENDIX D. EXPRESSION OF UNCERTAINTIES	 163
D.1 General considerations on errors and uncertainties.....	163
D.2 Type A standard uncertainties	163
D.3 Type B standard uncertainties	164
D.4 Combined and expanded uncertainties	165
 REFERENCES.....	 167
 IAEA MEETINGS RELATED TO THIS PUBLICATION	 177
 RECENT IAEA PUBLICATIONS ON RADIATION DOSIMETRY AND MEDICAL RADIATION PHYSICS.....	 179

1. INTRODUCTION

1.1. Background

In its Report 24 on *Determination of Absorbed Dose in a Patient Irradiated by Beams of X or Gamma Rays in Radiotherapy Procedures*, the ICRU [1] concluded “although it is too early to generalize, the available evidence for certain types of tumour points to the need for an accuracy of $\pm 5\%$ in the delivery of an absorbed dose to a target volume if the eradication of the primary tumour is sought”. ICRU continues “Some clinicians have requested even closer limits such as $\pm 2\%$, but at the present time (in 1976) it is virtually impossible to achieve such a standard”. These statements were given in a context where uncertainties were estimated at the 95% confidence level, and have been interpreted as if they correspond to approximately two standard deviations. Thus the requirement for an accuracy of 5% in the delivery of absorbed dose would correspond to a combined uncertainty of 2.5% at the level of one standard deviation. Today it is considered that a goal in dose delivery to the patient based on such an accuracy requirement is too strict and the figure should be increased to about one standard deviation of 5%, but there are no definite recommendations in this respect ¹. The requirement for an accuracy of $\pm 5\%$ could, on the other hand, be also interpreted as a tolerance for the deviation between the prescribed dose and the dose delivered to the target volume. Modern radiotherapy has confirmed, in any case, the need for high accuracy in dose delivery if new techniques, including dose escalation in 3D conformal radiotherapy, are to be applied. Emerging technologies in radiotherapy, for example modern diagnostic tools for the determination of the target volume, 3D commercial treatment planning systems and advanced accelerators for irradiation, can only be fully utilized if there is high accuracy in dose determination and delivery.

The various steps between the calibration of ionization chambers in terms of the quantity air kerma, K_{air} , at the standardizing dosimetry laboratories and the determination of absorbed dose to water, D_w , at hospitals using dosimetry protocols based on the factor ² $N_{D,air}$ (or N_{gas}) introduce undesirable uncertainties into the realization of D_w . Many factors are involved in the dosimetric chain that starts with a calibration factor in terms of air kerma, N_K , measured in air using a ⁶⁰Co beam and ends with the absorbed dose to water, D_w , measured in water in clinical beams. Uncertainties in the chain arise mainly from conversions performed by the user at the hospital, for instance the well-known k_m and k_{att} factors used in most Codes of Practice and dosimetry protocols [8-19]. Uncertainties associated with the conversion of N_K to $N_{D,air}$ (or N_{gas}) mean that in practice the starting point of the calibration of clinical beams already involves a considerable uncertainty [20]. The estimation of uncertainties given in previous IAEA Codes of Practice, TRS-277 and TRS-381 [17, 21] showed that the largest contribution to the uncertainty during beam calibration arises from the different physical quantities involved and the large number of steps performed, yielding standard uncertainties of up to 3 or 4%. Even if more recent uncertainty estimates [22, 23] have lowered these figures, the contribution from the first steps in the radiotherapy dosimetry chain still do not comply with the demand for a low uncertainty to minimize the final uncertainty in patient dose delivery.

¹ Several studies have concluded that for certain types of tumors the combined standard uncertainty in dose delivery should be smaller than 3.3% or 3.5% [2-4], “even if in many cases larger values are acceptable and in some special cases even smaller values should be aimed at” [3]. It has also been stated that taking into account the uncertainties in dose calculation algorithms, a more appropriate limit for the combined standard uncertainty of the dose delivered to the target volume would be around 5% [4, 5].

² The standard ISO 31-0 [6], *Quantities and units*, has provided guidelines with regard to the use of the term *coefficient*, which should be used for a multiplier possessing dimensions, and *factor*, which should be reserved for a dimensionless multiplier. The more recent standard IEC-60731 [7] is not consistent, however, with the ISO vocabulary and still provides a definition of the term *calibration factor*. Although the present Code of Practice continues using the term *calibration factor*, users should be aware of the possibility of a change in terminology by standards laboratories in favour of *calibration coefficient*.

Reich [24] proposed the calibration of therapy-level dosimeters in terms of absorbed dose to water, stressing the advantages of using the same quantity and experimental conditions as the user. The current status of development of primary standards of absorbed dose to water for high-energy photons and electrons, and the improvement in radiation dosimetry concepts and data available, have made it possible to reduce the uncertainty in the calibration of radiation beams. The development of standards of absorbed dose to water at Primary Standard Dosimetry Laboratories (PSDLs) has been a major goal pursued by the *Comité Consultatif pour les Etalons de Mesure des Rayonnements Ionisants (Section I)* [25]. Measurements of absorbed dose to graphite using graphite calorimeters were developed first and continue to be used in many laboratories. This procedure was considered as an intermediate step between air kerma and direct determination of the absorbed dose to water, since absolute calorimetric measurements in water are more problematic. Comparisons of determinations of absorbed dose to graphite were satisfactory, and consequently, the development of standards of absorbed dose to water was undertaken in some laboratories. Procedures to determine absorbed dose to water using methods to measure appropriate base or derived quantities have considerably improved at the PSDLs in the last decade. The well established procedures are the ionization method, chemical dosimetry, and water and graphite calorimetry. Although only the water calorimeter allows the direct determination of the absorbed dose to water in a water phantom, the required conversion and perturbation factors for the other procedures are now well known at many laboratories. These developments lend support to a change in the quantity used at present to calibrate ionization chambers and provide calibration factors in terms of absorbed dose to water, $N_{D,w}$, for use in radiotherapy beams. Many PSDLs already provide $N_{D,w}$ calibrations at ^{60}Co gamma-ray beams and some laboratories have extended these calibration procedures to high-energy photon and electron beams; others are developing the necessary techniques for such modalities.

At Secondary Standard Dosimetry Laboratories (SSDLs) calibration factors from a PSDL or from the *Bureau International des Poids et Mesures (BIPM)* are transferred to hospital users. For ^{60}Co gamma-ray beams most SSDLs can provide users with a calibration factor in terms of absorbed dose to water without much experimental effort, as all SSDLs have such beams. However, it is not possible for them, in general, to supply experimentally determined calibration factors at high-energy photon and electron beams. Numerical calculations of a beam quality correction factor, related to ^{60}Co can, however, be performed which should be equivalent to those obtained experimentally but with a larger uncertainty.

A major advance in radiotherapy over the last few years has been the increasing use of proton and heavy-ion irradiation facilities for radiation therapy. Practical dosimetry in these fields is also based on the use of ionization chambers that may be provided with calibrations both in terms of air kerma and in terms of absorbed dose to water. Therefore the dosimetry procedures developed for high-energy photons and electrons can also be applicable to protons and heavy ions. At the other extreme of the range of available teletherapy beams lie kilovoltage x-ray beams and for these the use of standards of absorbed dose to water was introduced in TRS-277 [17]. However, for kilovoltage x-rays there are, at present, very few laboratories providing $N_{D,w}$ calibrations because most PSDLs have not yet established primary standards of absorbed dose to water for such radiation qualities. Nevertheless $N_{D,w}$ calibrations in kilovoltage x-ray beams may be provided by PSDLs and SSDLs based on their standards of air kerma and one of the current dosimetry protocols for x-ray beams. Thus a coherent dosimetry system based on standards of absorbed dose to water is now possible for practically all radiotherapy beams³, see Fig. 1.1.

³ For neutron therapy beams, the reference material to which the absorbed dose relates is ICRU soft tissue [26]. The present Code of Practice is based on the quantity absorbed dose to water. Due to the strong dependence of neutron interaction coefficients on neutron energy and material composition, there is no straightforward procedure to derive absorbed dose to soft tissue from absorbed dose to water. Moreover, neutron dosimetry is traditionally performed with tissue-equivalent ionization chambers, flushed with a tissue-equivalent gas in order to determine the absorbed dose in an homogeneous medium. Although it is possible to express the resulting formalism [26] in terms of k_{Q,Q_0} , for most ionization chamber types there is a lack of data on the physical parameters which apply to the measurement of absorbed dose to water in a neutron beam. Therefore, the dosimetry of the radiotherapy neutron beams is not dealt with in this Code of Practice.

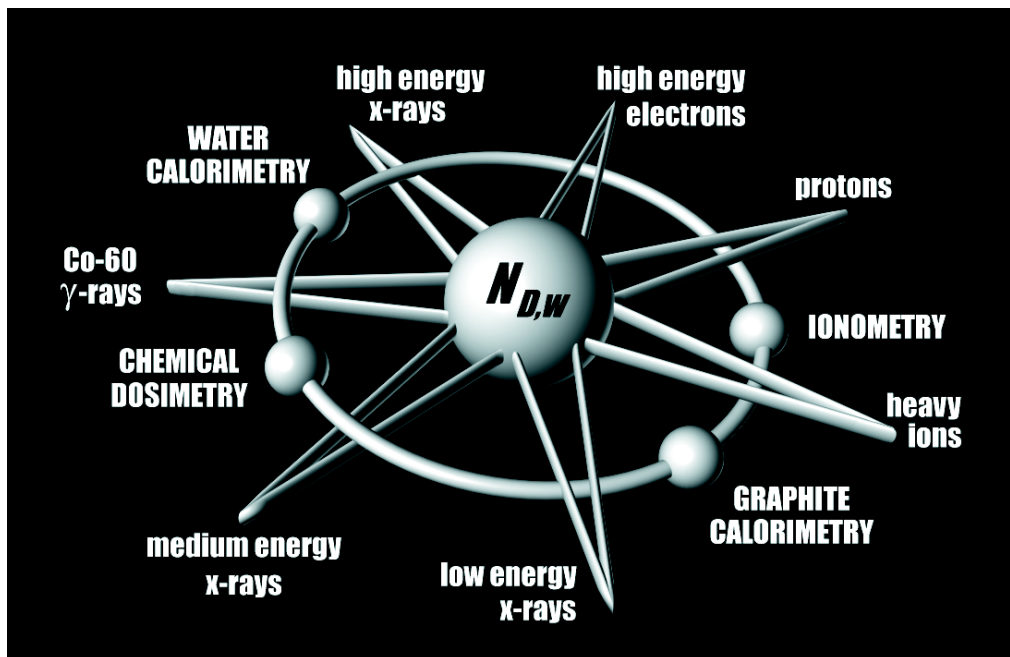

Fig 1.1. Coherent dosimetry system based on standards of absorbed dose to water. Primary standards based on water calorimetry, graphite calorimetry, chemical dosimetry, and ionometry allow the calibration of ionization chambers in terms of absorbed dose to water, $N_{D,w}$. A single Code of Practice provides the methodology for the determination of absorbed dose to water in the low, medium, ^{60}Co and high-energy photon beams, electron beams, proton beams and heavy-ion beams used for external radiation therapy.

This new international Code of Practice for the determination of absorbed dose to water in external beam radiotherapy, using an ionization chamber or a dosimeter having an $N_{D,w}$ calibration factor, will be applicable in all hospitals and facilities providing radiation treatment of cancer patients. Even though the nature of these institutions may be widely different, this Code of Practice will serve as a useful document to the medical physics and radiotherapy community and help achieve uniformity and consistency in radiation dose delivery throughout the world. The Code of Practice should also be of great value to the IAEA/WHO network of SSDLs in improving the accuracy and consistency of their dose determination and thereby the standardization of radiation dosimetry in the many countries which they serve.

1.2. Advantages of a Code of Practice based on standards of absorbed dose to water

Absorbed dose to water is the quantity of main interest in radiation therapy, since this quantity relates closely to the biological effects of radiation. The advantages of calibrations in terms of absorbed dose to water and dosimetry procedures using these calibration factors have been presented by several authors [20, 27, 28] and are described in detail in the ICRU Report on photon dosimetry [29]. A summary of the most relevant aspects is given below.

1.2.1. Reduced uncertainty

The drive towards an improved basis for dosimetry in radiotherapy has caused the PSDLs to devote much effort in the last two decades towards developing primary standards of absorbed dose to water. The rationale for changing the basis of calibrations from air kerma to absorbed dose to water was the expectation that the calibration of ionization chambers in terms of absorbed dose to water would reduce considerably the uncertainty in determining the absorbed dose to water in radiotherapy beams. Measurements based on calibration in air in terms of air kerma require chamber-dependent conversion factors to determine absorbed dose to water. These conversion factors do not account for differences between individual chambers of a particular type. In contrast, calibrations in terms of absorbed dose

to water can be performed under similar conditions to subsequent measurements in the user beam, so that the response of each individual chamber is taken into account. Fig. 1.2 shows chamber-to-chamber variations, demonstrated for a given chamber type by the lack of constancy in the $N_{D,w}/N_K$ ratio at ^{60}Co , for a large number of cylindrical ionization chambers commonly used in radiotherapy dosimetry. For a given chamber type, chamber-to-chamber differences of up to 0.8% have also been reported by the BIPM [30]. The elimination of the uncertainty component caused by the assumption that all chambers of a given type are identical is a justification for favouring direct calibration of ionization chambers in terms of absorbed dose to water.

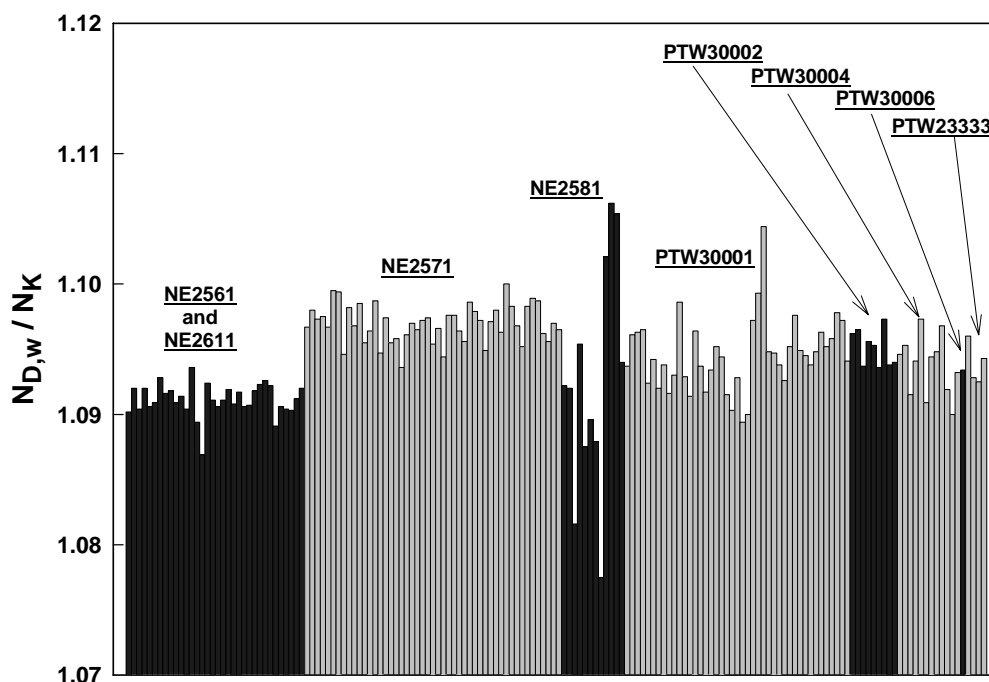

Fig 1.2. The ratio of ^{60}Co calibration factors $N_{D,w}/N_K$ is a useful indicator of the uniformity within a given type of chamber [30]. Chamber-to-chamber variations, demonstrated by differences in the ratio $N_{D,w}/N_K$ for chambers of a given type, are shown for a large number of cylindrical ionization chambers commonly used in radiotherapy dosimetry (see Table 4.1 for a description of each chamber type). The large variation for NE 2581 chambers is considered to be caused by the hygroscopic properties of the A-150 plastic walls. Data measured in the IAEA Dosimetry Laboratory.

In principle, primary standards of absorbed dose to water can operate in both ^{60}Co beams and accelerator beams. Thus, for high-energy photon and electron radiation an experimental determination of the energy dependence of ionization chambers becomes available, resulting in a reduced uncertainty due to the effect of beam quality. Similar conclusions can be drawn for therapeutic proton and heavy ions beams, although primary standards of absorbed dose to water are not yet available at these radiation qualities.

1.2.2. A more robust system of primary standards

Despite the fact that the quantity of interest in radiation dosimetry is absorbed dose to water, most national, regional and international dosimetry recommendations are based on the use of an air-kerma calibration factor for an ionization chamber, traceable to a national or international primary standard of air kerma for ^{60}Co gamma radiation. Although international comparisons of these standards have exhibited very good agreement, a substantial weakness prevails in that all such standards are based on ionization chambers and are therefore subject to common errors. In addition, depending on the method of evaluation, a factor related to the attenuation in the chamber wall entering into the determination of the quantity air kerma has been found to differ by up to 0.7% for some primary standards [31]. In contrast, primary standards of absorbed dose to water are based on a number of different physical

principles. There are no assumptions or estimated correction factors common to all of them. Therefore good agreement among these standards (see Section 2.2) gives much greater confidence in their accuracy.

1.2.3. Use of a simple formalism

The formalism given in TRS-277 [17] and in most national and international dosimetry protocols for the determination of absorbed dose to water in radiotherapy beams is based on the application of several coefficients, perturbation and other correction factors. This is because of the practical difficulty in making the conversion from the free-air quantity air kerma to the in-phantom quantity absorbed dose to water. This complexity is best demonstrated by considering the equations needed, and the procedures for selecting the appropriate data. Reliable information about certain physical characteristics of the ionization chamber used is also required. Many of these data, such as displacement correction factors and stopping-power ratios, are derived from complex measurements or calculations based on theoretical models. A simplified procedure starting from a calibration factor in terms of absorbed dose to water, and applying correction factors for all influence quantities, reduces the possibility of errors in the determination of absorbed dose to water in the radiation beam. The simplicity of the formalism in terms of absorbed dose to water becomes obvious when the general equation for the determination of absorbed dose to water is considered (see Section 3).

1.3. Types of radiation and range of beam qualities

The present Code of Practice provides a methodology for the determination of absorbed dose to water in the low-, medium- and high-energy photon beams, electron beams, proton beams and heavy-ion beams used for external radiation therapy. The ranges of radiation qualities covered in this document are given below (for a description of the beam quality index see the corresponding Sections):

- (a) low-energy x-rays with generating potentials up to 100 kV and HVL of 3 mm Al (the lower limit is determined by the availability of standards) ⁴
- (b) medium-energy x-rays with generating potentials above 80 kV and HVL of 2 mm Al ⁴
- (c) ⁶⁰Co gamma-radiation
- (d) high-energy photons generated by electrons with energies in the interval 1 MeV to 50 MeV, with $TPR_{20,10}$ values between 0.50 and 0.84
- (e) electrons in the energy interval 3 MeV to 50 MeV, with a half-value depth, R_{50} , between 1 g cm^{-2} and 20 g cm^{-2}
- (f) protons in the energy interval 50 MeV to 250 MeV, with a practical range, R_p , between 0.25 g cm^{-2} and 25 g cm^{-2}
- (g) heavy ions with Z between 2 (He) and 18 (Ar) having a practical range in water, R_p , of 2 g cm^{-2} to 30 g cm^{-2} (for carbon ions this corresponds to an energy range of 100 MeV/u to 450 MeV/u, where u is the atomic mass unit).

1.4. Practical use of the Code of Practice

Emphasis has been given to making the practical use of this document as simple as possible. The structure of this Code of Practice differs from TRS-277 [17] and more closely resembles TRS-381 [21] in that the practical recommendations and data for each radiation type have been placed in an individual section devoted to that radiation type. Each essentially forms a different Code of Practice including detailed procedures and worksheets. The reader can perform a dose determination for a given beam by working through the appropriate Section; the search for procedures or tables contained in other parts of the document has been reduced to a minimum. Making the various Codes of Practice independent and self-contained has required an unavoidable repetition of some portions of text, but

⁴ The boundary between the two ranges for kilovoltage x-rays is not strict and has an overlap between 80 kV, 2 mm Al and 100 kV, 3 mm Al. In this overlap region the methods for absorbed dose determination of either Section 8 or 9 are equally satisfactory and whichever is more convenient should be used.

this is expected to result in a document which is simpler and easier to use, especially for users having access to a limited number of radiation types. The first four Sections contain general concepts that apply to all radiation types. Appendices provide a complement to the information supplied in the various Sections.

Compared with previous Codes of Practice or dosimetry protocols based on standards of air kerma (c.f. TRS-277 [17] and TRS-381 [21]), the adoption of the new Code of Practice will introduce small differences in the value of the absorbed dose to water determined in clinical beams. Detailed comparisons will be published in the open literature, and the results are expected to depend on the type and quality of the beam and on the type of ionization chamber. Where differences arise, it is important to notice that they might be due to two contributions: i) inaccuracies in the numerical factors and expressions (for example k_m , p_{wall} , etc.) in the N_K -based method and, to a lesser extent, in the present Code of Practice, and ii) the primary standards to which the calibrations in terms of air kerma and absorbed dose to water are traceable. Even for ^{60}Co gamma radiation, which is generally better characterized than other modalities, beam calibrations based on the two different standards, K_{air} and D_w , differ by typically 1% (see Appendix A); the value derived using the present Code of Practice is considered to be the better estimate. Any conclusions drawn from comparisons between protocols based on standards of air kerma and absorbed dose to water must take account of the differences between primary standards.

1.5. Expression of uncertainties

The evaluation of uncertainties in this Code of Practice follows the guidance given by ISO [32]. Uncertainties of measurements are expressed as relative standard uncertainties and the evaluation of standard uncertainties is classified into type A and type B. The method of evaluation of type A standard uncertainty is by statistical analysis of a series of observations, whereas the method of evaluation of type B standard uncertainty is based on means other than statistical analysis of a series of observations. A practical implementation of the ISO recommendations, based on the summaries provided in IAEA TRS-374 [33] and IAEA TRS-277 [17], is given for completeness in Appendix D of this Code of Practice.

Estimates of the uncertainty in dose determination for the different radiation types are given in the appropriate Sections. Compared with estimates in previous Codes of Practice, the present values are generally smaller. This arises from the greater confidence in determinations of absorbed dose to water based on D_w standards and, in some cases, from a more rigorous analysis of uncertainties in accordance with the ISO guidelines.

1.6. Quantities and symbols

Most of the symbols used in this Code of Practice are identical to those used in TRS-277 [17] and TRS-381 [21], and only a few are new in the context of standards of absorbed dose to water. For completeness a summary is provided here for all quantities of relevance to the different methods used in the present Code of Practice.

c_{pl} Material-dependent scaling factor to convert ranges and depths measured in plastic phantoms into the equivalent values in water. This applies to electron, proton and heavy-ion beams. Note that in the present Code of Practice the depths and ranges are defined in units of g cm^{-2} , in contrast to their definition in cm in TRS-381 [21] for electron beams. As a result, the values given for c_{pl} in the present Code of Practice for electrons differ from those for C_{pl} given in TRS-381. The use of lowercase for c_{pl} denotes this change.

$csda$ Continuous slowing-down approximation.

$D_{w,Q}$	Absorbed dose to water at the reference depth, z_{ref} , in a water phantom irradiated by a beam of quality Q . The subscript Q is omitted when the reference beam quality is ^{60}Co . Unit: gray, Gy
E_o, E_z	Mean energy of an electron beam at the phantom surface and at depth z , respectively. Unit: MeV.
h_{pl}	Material-dependent fluence scaling factor to correct for the difference in electron fluence in plastic compared with that in water at an equivalent depth.
HVL	Half-value layer, used as a beam quality index for low- and medium-energy x-ray beams.
k_i	General correction factor used in the formalism to correct for the effect of the difference in the value of an influence quantity between the calibration of a dosimeter under reference conditions in the standards laboratory and the use of the dosimeter in the user facility under different conditions.
k_{elec}	Calibration factor of an electrometer.
k_h	Factor to correct the response of an ionization chamber for the effect of humidity if the chamber calibration factor is referred to dry air.
k_{pol}	Factor to correct the response of an ionization chamber for the effect of a change in polarity of the polarizing voltage applied to the chamber.
k_{Q,Q_o}	Factor to correct for the difference between the response of an ionization chamber in the reference beam quality Q_o used for calibrating the chamber and in the actual user beam quality, Q . The subscript Q_o is omitted when the reference quality is ^{60}Co gamma radiation (i.e., the reduced notation k_Q always corresponds to the reference quality ^{60}Co).
k_s	Factor to correct the response of an ionization chamber for the lack of complete charge collection (due to ion recombination).
k_{TP}	Factor to correct the response of an ionization chamber for the effect of the difference that may exist between the standard reference temperature and pressure specified by the standards laboratory and the temperature and pressure of the chamber in the user facility under different environmental conditions.
M_Q	Reading of a dosimeter at the quality Q , corrected for influence quantities other than beam quality. Unit: C or rdg.
M_{em}	Reading of a dosimeter used as external monitor. Unit: C or rdg.
$(\mu_{en}/\rho)_{m_1,m_2}$	ratio of the mean mass energy-absorption coefficients of materials m_1 and m_2 , averaged over a photon spectrum
$N_{D,air}$	Absorbed dose to air chamber factor of an ionization chamber used in air-kerma based dosimetry protocols (c.f. IAEA TRS-277 [17] and TRS-381 [17, 21]). This is the N_{gas} of AAPM TG-21 [9]. The factor $N_{D,air}$ was called N_D in ICRU Report 35 [11] and in TRS-277 [17], but the subscript “air” was included in TRS-381 [21] to specify without ambiguity that it refers to the absorbed dose to the air of the chamber cavity. Care should be paid by the user to avoid confusing $N_{D,air}$, or the former N_D , with the calibration factor in terms of absorbed dose to water $N_{D,w}$ described below (see Appendix A). Unit: Gy/C or Gy/rdg.

N_{D,w,Q_o}	Calibration factor in terms of absorbed dose to water for a dosimeter at a reference beam quality Q_o . The product $M_{Q_o} N_{D,w,Q_o}$ yields the absorbed dose to water, D_{w,Q_o} , at the reference depth z_{ref} and in the absence of the chamber. The subscript Q_o is omitted when the reference quality is a beam of ^{60}Co gamma rays (i.e., $N_{D,w}$ always corresponds to the calibration factor in terms of absorbed dose to water in a ^{60}Co beam). The factor $N_{D,w}$ was called N_D in AAPM TG-21 [9], where a relationship between N_{gas} and N_D was given similar to that described in Section 3.3 and Appendix A. The symbol N_D is also used in calibration certificates issued by some standards laboratories and manufacturers instead of $N_{D,w}$. Users are strongly recommended to ascertain the physical quantity used for the calibration of their detectors in order to avoid severe mistakes ⁵ . Unit: Gy/C or Gy/rdg.
N_{K,Q_o}	Calibration factor in terms of air kerma for a dosimeter at a reference beam quality Q_o . Unit: Gy/C or Gy/rdg.
p_{cav}	Factor that corrects the response of an ionization chamber for effects related to the air cavity, predominantly the in-scattering of electrons that makes the electron fluence inside a cavity different from that in the medium in the absence of the cavity.
p_{cel}	Factor that corrects the response of an ionization chamber for the effect of the central electrode during in-phantom measurements in high-energy photon (including ^{60}Co), electron and proton beams. Note that this factor is not the same as in TRS-277 [17], where the correction took into account the global effect of the central electrode both during the calibration of the chamber in air in a ^{60}Co beam, and during subsequent measurements in photon and electron beams in a phantom. To avoid ambiguities TRS-381 [21] called the correction factor used in TRS-277 $p_{cel-gbl}$, keeping the symbol p_{cel} exclusively for in-phantom measurements (see Appendix A).
PDD	Percentage depth-dose.
p_{dis}	Factor that accounts for the effect of replacing a volume of water with the detector cavity when the reference point of the chamber ⁶ is taken to be at the chamber centre. It is the alternative to the use of an effective point of measurement of the chamber, P_{eff} . For plane-parallel ionization chambers p_{dis} is not required.
P_{eff}	The effective point of measurement of an ionization chamber. For the standard calibration geometry, i. e. a radiation beam incident from one direction, P_{eff} is shifted from the position of the centre towards the source by a distance which depends on the type of beam and chamber. For plane-parallel ionization chambers P_{eff} is usually assumed to be situated in the centre of the front surface of the air cavity ⁷ . The concept of the effective point of measurement of a cylindrical ionization chamber was used for all radiation types in TRS-277 [17] but in the present Code of Practice it is only used for electron and heavy-ion beams. For other beams, reference dosimetry is based on positioning the reference point of the chamber at the reference depth, z_{ref} , where the dose is determined. The reference point of an ionization chamber is specified for each radiation type in the corresponding Section.

⁵ The difference between $N_{D,air}$ and $N_{D,w}$ is close to the value of the stopping-power ratio, water to air, in ^{60}Co gamma rays. A confusion in the meaning of the factors could therefore result in an error in the dose delivered to patients of approximately 13% (see Appendix A).

⁶ The reference point of a chamber is specified in this Code of Practice in each Section for each type of chamber. It usually refers to the point of the chamber specified by a calibration document to be that at which the calibration factor applies [33].

⁷ This assumption might fail if the chamber design does not follow certain requirements regarding the ratio of cavity diameter to cavity height as well as that of guard-ring width to cavity height (see TRS-381 [21]).

p_Q	Overall perturbation factor for an ionization chamber for in-phantom measurements at a beam quality Q . It is equal to the product of various factors correcting for different effects, each correcting for small perturbations; in practice these are p_{cav} , p_{cel} , p_{dis} and p_{wall} .
p_{wall}	Factor that corrects the response of an ionization chamber for the non-medium equivalence of the chamber wall and any waterproofing material.
Q	General symbol to indicate the quality of a radiation beam. A subscript “o”, i.e. Q_o , indicates the reference quality used for the calibration of an ionization chamber or a dosimeter.
rdg	value, in arbitrary units, used for the reading of a dosimeter.
R_{50}	Half-value depth in water (in $g\ cm^{-2}$), used as the beam quality index for electron beams.
R_p	Practical range (in $g\ cm^{-2}$) for electron, proton and heavy-ion beams.
R_{res}	Residual range (in $g\ cm^{-2}$) for proton beams.
r_{cyl}	Cavity radius of a cylindrical ionization chamber.
SAD	Source-axis distance.
SCD	Source-chamber distance.
$SOBP$	Spread-out Bragg peak.
SSD	Source-surface distance.
$s_{m,air}$	Stopping-power ratio medium to air, defined as the ratio of the mean restricted mass stopping powers of materials m and air, averaged over an electron spectrum. For all high-energy radiotherapy beams in this Code of Practice, except for heavy-ion beams, stopping-power ratios are of the Spencer-Attix type with a cut-off energy $\Delta=10$ keV (see ICRU Report 35 [11]).
TMR	Tissue-maximum ratio.
$TPR_{20,10}$	Tissue-phantom ratio in water at depths of 20 and 10 g/cm^2 , for a field size of 10 cm x 10 cm and a SCD of 100 cm, used as the beam quality index for high-energy photon radiation.
u_c	Combined standard uncertainty of a quantity.
W_{air}	The mean energy expended in air per ion pair formed.
z_{max}	Depth of maximum dose (in $g\ cm^{-2}$)
z_{ref}	Reference depth (in $g\ cm^{-2}$) for in-phantom measurements. When specified at z_{ref} , the absorbed dose to water refers to $D_{w,Q}$ at the intersection of the beam central axis with the plane defined by z_{ref} .

1.7. List of acronyms

The following acronyms are used throughout this document to refer to different organizations relevant to the field of radiation dosimetry:

ARPANSA	Australian Radiation Protection and Nuclear Safety Agency, Australia
BEV	Bundesamt für das Eich- und Vermessungswesen, Austria
BIPM	Bureau International des Poids et Mesures
CCEMRI(I)	Comité Consultatif pour les Etalons de Mesure des Rayonnements Ionisants (Section I) (Consultative Committee for Standards of Ionizing Radiation) Since September 1997 the CCEMRI and its Sections has been renamed the CCRI.
CCRI(I)	Comité Consultatif des Rayonnements Ionisants (Section I) (Consultative Committee for Ionizing Radiation)
CIPM	Comité International des Poids et Mesures
ENEA-INMRI	Ente per le Nuove Tecnologie, l'Energia e l'Ambiente, Istituto Nazionale di Metrologia delle Radiazioni Ionizzanti, Italy
IAEA	International Atomic Energy Agency
ICRU	International Commission on Radiation Units and Measurements
IEC	International Electrotechnical Commission
IMS	International Measurement System
ISO	International Organization for Standardization
LPRI	Laboratoire Primaire de Métrologie des Rayonnements Ionisants, France
NIST	National Institute of Standards and Technology, USA
NPL	National Physical Laboratory, Great Britain
NRC	National Research Council, Canada
NRL	National Radiation Laboratory, New Zealand
OIML	Organisation Internationale de Métrologie Légale
PSDL	Primary Standard Dosimetry Laboratory
PTB	Physikalisch-Technische Bundesanstalt, Germany
SSDL	Secondary Standard Dosimetry Laboratory

2. FRAMEWORK

2.1. The International Measurement System

The International Measurement System (IMS) for radiation metrology provides the framework for consistency in radiation dosimetry by disseminating to users calibrated radiation instruments which are traceable to primary standards (see Fig 2.1).

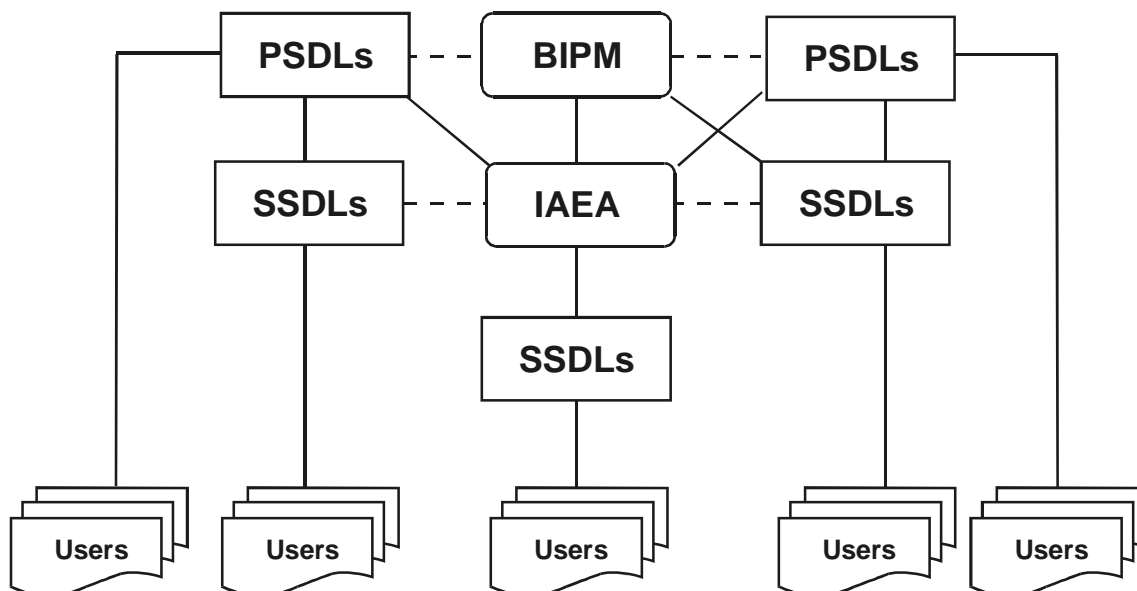

Fig 2.1. The International Measurement System (IMS) for radiation metrology, where the traceability of user reference instruments to Primary Standards is achieved either by direct calibration in a Primary Standard Dosimetry Laboratory (PSDL) or, more commonly, in a Secondary Standard Dosimetry Laboratory (SSDL) with direct link to the BIPM, a PSDL or to the IAEA/WHO network of SSDLs. Most SSDLs from countries not members of the Metre Convention achieve the traceability of their standards through the IAEA. The dashed lines indicate intercomparisons of primary and secondary standards.

The BIPM was set up by the Metre Convention (originally signed in 1875, with 48 Member States as of 31 December 1997 [34]) as the international centre for metrology, with its laboratory and offices in Sèvres (France), in order to ensure world-wide uniformity on matters relating to metrology. In radiation dosimetry, the PSDLs of many Member States of the Metre Convention have developed primary standards for radiation measurements (see Table 2.I) that are compared with those of the BIPM and other PSDLs. However, world-wide there are only some twenty countries with PSDLs involved in radiation dosimetry and they cannot calibrate the very large number of radiation dosimeters that are in use all over the world. Those national laboratories that maintain primary standards calibrate the secondary standards of SSDLs (see Table 2.I), which in turn calibrate the reference instruments of users (some PSDLs also calibrate the reference instruments of users).

2.1.1. The IAEA/WHO network of SSDLs

The main role of SSDLs is to bridge the gap between the PSDLs and the users of ionizing radiation by enabling the transfer of dosimeter calibrations from the primary standard to the user instrument [35]. In 1976 a network of SSDLs was established as a joint effort by the IAEA and the WHO in order to disseminate calibrations to users by providing the link between users and primary standards, mainly for countries that are not members of the Metre Convention. By 1998 the network included 70 laboratories and 6 SSDL national organizations in 58 IAEA Member States, of which over half are in developing countries. The SSDL network also includes 16 affiliated members, among them the BIPM,

several national PSDLs, the ICRU and other international organizations that provide support to the network [36].

TABLE 2.I. CLASSIFICATION OF INSTRUMENTS AND STANDARDS LABORATORIES
(Adapted from IAEA TRS-374 [33])

Classification of instruments	Standards laboratories
<p>Primary standard An instrument of the highest metrological quality that permits determination of the unit of a quantity from its definition, the accuracy of which has been verified by comparison with the comparable standards of other institutions at the same level.</p>	<p>Primary Standard Dosimetry Laboratory (PSDL) A national standardizing laboratory designated by the government for the purpose of developing, maintaining and improving primary standards in radiation dosimetry.</p>
<p>Secondary standard An instrument calibrated by comparison with a primary standard.</p>	<p>Secondary Standard Dosimetry Laboratory (SSDL) A dosimetry laboratory designated by the competent authorities to provide calibration services, and which is equipped with at least one secondary standard that has been calibrated against a primary standard.</p>
<p>National standard A standard recognized by an official national decision as the basis for fixing the value in a country of all other standards of the given quantity.</p>	
<p>Reference instrument An instrument of the highest metrological quality available at a given location, from which measurements at that location are derived.</p>	
<p>Field instrument A measuring instrument used for routine measurements whose calibration is related to the reference instrument.</p>	

As the organizer of the network, the IAEA has the responsibility to verify that the services provided by the SSDL member laboratories follow internationally accepted metrological standards (including the traceability for radiation protection instruments). The first step in this process is the dissemination of dosimeter calibrations from the BIPM or PSDLs through the IAEA to the SSDLs. In the next step, follow-up programmes and dose quality audits are implemented by the IAEA for the SSDLs to guarantee that the standards disseminated to users are kept within the levels of accuracy required by the IMS [36].

One of the principal goals of the SSDL network in the field of radiotherapy dosimetry is to guarantee that the dose delivered to patients undergoing radiotherapy treatment is within internationally accepted levels of accuracy. This is accomplished by ensuring that the calibrations of instruments provided by the SSDLs are correct, emphasizing the participation of the SSDLs in quality assurance programmes for radiotherapy, promoting the contribution of the SSDLs to support dosimetry quality audits in therapy centres, and assisting if needed in performing the calibration of radiotherapy equipment in hospitals.

2.2. Standards of absorbed dose to water

There are three basic methods currently used for the absolute determination of absorbed dose to water: calorimetry, chemical dosimetry and ionization dosimetry. At present, these are the only methods that are sufficiently accurate to form the basis of primary standards for measurements of absorbed dose to water [29]. The PSDLs have developed various experimental approaches to establish standards of absorbed dose to water. These standards are described briefly and results of international comparisons of absorbed dose to water are presented below.

In most PSDLs the primary standards of absorbed dose to water operate in a ^{60}Co gamma-ray beam and in some PSDLs the standards of absorbed dose to water operate also at other radiation qualities such as high-energy photons, electrons and kilovoltage x-rays. Primary standards operating in ^{60}Co gamma-ray beams or in photon and electron beams produced by accelerators are based on one of the following methods:

- I. The ionization chamber primary standard consists of a graphite cavity chamber with accurately known chamber volume, designed to fulfil as far as possible the requirements of a Bragg-Gray detector. The chamber is placed in a water phantom and the absorbed dose to water at the reference point derived from the mean specific energy imparted to the air of the cavity [37].
- II. The graphite calorimeter developed by Domen and Lamperti [38] is used with slight modifications by several PSDLs to determine the absorbed dose to graphite in a graphite phantom. The conversion to absorbed dose to water at the reference point in a water phantom may be performed in different ways, e.g. by application of the photon fluence scaling theorem or by measurements based on cavity ionization theory [39, 40].
- III. The water calorimeter offers a more direct determination of the absorbed dose to water at the reference point in a water phantom. The sealed water system [41, 42] consists of a small glass vessel containing high-purity water and a thermistor detector unit. Water purity is important because the heat defect of water is strongly influenced by impurities. With the sealed water arrangement high-purity water can be saturated with various gases to create a mixture for which the heat defect has a well-defined and stable value.
- IV. The water calorimeter with Fricke transfer dosimeter [43] is based on the measurement of the average temperature increase induced by the absorption of high-energy photons. The water is stirred continuously and the absorbed dose to water averaged over the volume of the vessel is determined. Fricke solution is calibrated by irradiation under the same conditions and the absorbed dose to water at the reference point in a water phantom is obtained using the Fricke dosimeter as the transfer standard.
- V. The Fricke standard of absorbed dose to water determines the response of Fricke solution using the total absorption of an electron beam in the solution [44]. Knowing the electron energy, the beam current and the absorbing mass accurately, the total absorbed energy can be determined and related to the change in absorbance of the Fricke solution as measured spectrophotometrically. The absorbed dose to water at the reference point in a water phantom is obtained using the Fricke dosimeter as the transfer standard.

The methods outlined above are not applied at PSDLs to primary standards for use in kilovoltage x-ray beams. Absolute measurements for the determination of absorbed dose to water in kilovoltage x-ray beams have been based so far almost exclusively on the use of extrapolation ionization chambers [45].

Comparisons of primary standards of absorbed dose to water have been carried out over the past decade [29, 46, 47], whereas comparisons of air-kerma primary standards have a much longer history. Results of comparisons at the BIPM in terms of absorbed dose to water for ^{60}Co gamma radiation are given in Ref. [48], see Fig. 2.2a. The agreement is well within the relative standard uncertainties estimated by each PSDL. Comparisons of air-kerma primary standards for ^{60}Co gamma radiation exhibit a similar standard deviation, see Fig. 2.2b. However, the air-kerma primary standards of all PSDLs are graphite cavity ionization chambers and the conversion and correction factors used are strongly correlated. As can be seen from Table 2.II the PSDLs involved in the comparisons of absorbed dose to water use different methods to determine absorbed dose to water which have uncorrelated, or very weakly correlated, uncertainties and constitute a system which is more robust than the primary standards based on air kerma and less susceptible to unknown systematic influences.

TABLE 2.II. PRIMARY STANDARDS USED IN THE COMPARISONS OF ABSORBED DOSE TO WATER AT THE BIPM

PSDL	Primary Standard	PSDL	Primary Standard
BIPM	ionization chamber	NIST (USA)	sealed water calorimeter
ARPANSA (Australia)	graphite calorimeter	NPL (Great Britain)	graphite calorimeter
BEV (Austria)	graphite calorimeter	NRC (Canada)	sealed water calorimeter
ENEA (Italy)	graphite calorimeter	PTB (Germany)	Fricke dosimeter
LPRI (France)	graphite calorimeter		

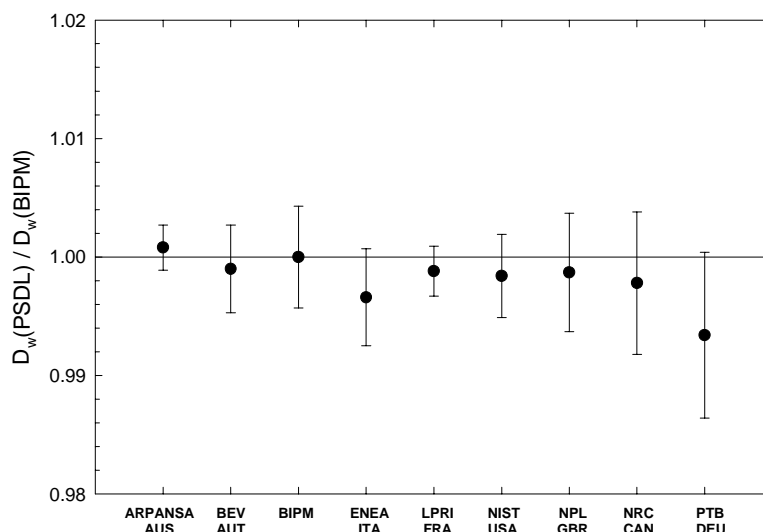

Fig 2.2a. Results of comparisons of standards of absorbed dose to water at the BIPM in the ^{60}Co beam [48]. The results are relative to the BIPM determination and are those for the most recent comparison for each national metrology institute, the oldest dating from 1989. The uncertainty bars represent the relative standard uncertainty of the determination of absorbed dose to water at each institute. Information on the primary standards used by the PSDLs is given in Table 2.II.

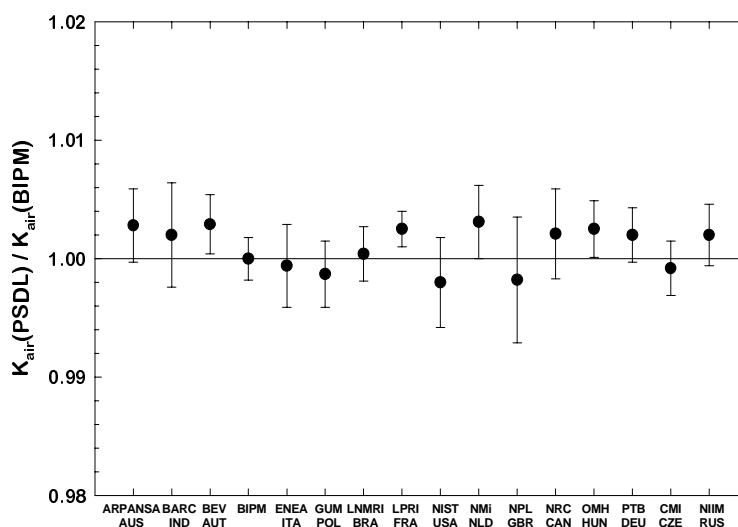

Fig 2.2b. Results of comparisons of standards of air kerma at the BIPM in the ^{60}Co beam [48]. The results are relative to the BIPM determination and are those for the most recent comparison for each national metrology institute. The uncertainty bars represent the relative standard uncertainty of the air-kerma determination at each institute.

3. $N_{D,w}$ -BASED FORMALISM

The formalism for the determination of absorbed dose to water in high-energy photon and electron beams using an ionization chamber or a dosimeter calibrated in terms of absorbed dose to water in a ^{60}Co beam has been given in detail by Hohlfeld [27]. Complementary work on this topic and extensions of the formalism have been developed by Andreo [20] and Rogers [28]. The procedure for the determination of absorbed dose to water based on standards of absorbed dose to water has been implemented in the national dosimetry recommendations by the IPSM [49], DIN 6800-2 [50], and AAPM TG-51 [51]. It was also included in the IAEA Code of Practice for plane-parallel ionization chambers, TRS-381 [21].

3.1. Formalism

The absorbed dose to water at the reference depth z_{ref} in water for a reference beam of quality Q_0 and in the absence of the chamber is given by

$$D_{w,Q_0} = M_{Q_0} N_{D,w,Q_0} \quad (3.1)$$

where M_{Q_0} is the reading of the dosimeter under the reference conditions used in the standards laboratory and N_{D,w,Q_0} is the calibration factor in terms of absorbed dose to water of the dosimeter obtained from a standards laboratory. In most clinical situations the measurement conditions do not match the reference conditions used in the standards laboratory. This may affect the response of the dosimeter and it is then necessary to differentiate between the reference conditions used in the standards laboratory and the clinical measurement conditions.

3.1.1. Reference conditions

The calibration factor for an ionization chamber irradiated under reference conditions is the ratio of the *conventional true value* of the quantity to be measured to the indicated value⁸. Reference conditions are described by a set of values of influence quantities for which the calibration factor is valid without further correction factors. The reference conditions for calibrations in terms of absorbed dose to water are, for example, the geometrical arrangement (distance and depth), the field size, the material and dimensions of the irradiated phantom, and the ambient temperature, pressure and relative humidity.

3.1.2. Influence quantities

Influence quantities are defined as quantities not being the subject of the measurement, but yet influencing the quantity under measurement. They may be of different nature as, for example, pressure, temperature and polarization voltage; they may arise from the dosimeter (e.g. ageing, zero drift, warm-up), or may be quantities related to the radiation field (e.g. beam quality, dose rate, field size, depth in a phantom).

In calibrating an ionization chamber or a dosimeter as many influence quantities as practicable are kept under control. However, many influence quantities cannot be controlled, for example air pressure and humidity, and dose rate in ^{60}Co gamma radiation. It is possible to correct for the effect of these

⁸ The *conventional true value* of a quantity is the value attributed to a particular quantity and accepted, sometimes by convention, as having an uncertainty appropriate for a given purpose. The conventional true value is sometimes called assigned value, best estimate of the value, conventional value or reference value [52]. At a given laboratory or hospital, the value realized by a reference standard may be taken as a conventional true value and, frequently, the mean of a number of results of measurements of a quantity is used to establish a conventional true value.

influence quantities by applying appropriate factors. Assuming that influence quantities act independently from each other, a product of correction factors can be applied, $\prod k_i$, where each correction factor k_i is related to one influence quantity only. The independence of the k_i holds for the common corrections for pressure and temperature, polarity, collection efficiency, etc. which are dealt with in Section 4.

A departure from the reference beam quality Q_o used to calibrate an ionization chamber can also be treated as an influence quantity. Measurements at radiation qualities other than the reference quality Q_o therefore require a correction factor. In this Code of Practice this is treated explicitly by the factor k_{Q,Q_o} which is not included in the k_i above; the correction for the radiation beam quality is described in detail below.

3.2. Correction for the radiation quality of the beam, k_{Q,Q_o}

When a dosimeter is used in a beam of quality Q different from that used in its calibration, Q_o , the absorbed dose to water is given by

$$D_{w,Q} = M_Q N_{D,w,Q_o} k_{Q,Q_o} \quad (3.2)$$

where the factor k_{Q,Q_o} corrects for the effects of the difference between the reference beam quality Q_o and the actual user quality Q , and the dosimeter reading M_Q has been corrected to the reference values of influence quantities, other than beam quality, for which the calibration factor is valid.

The beam quality correction factor k_{Q,Q_o} is defined as the ratio, at the qualities Q and Q_o , of the calibration factors in terms of absorbed dose to water of the ionization chamber

$$k_{Q,Q_o} = \frac{N_{D,w,Q}}{N_{D,w,Q_o}} = \frac{D_{w,Q} / M_Q}{D_{w,Q_o} / M_{Q_o}} \quad (3.3)$$

The most common reference quality Q_o used for the calibration of ionization chambers is ^{60}Co gamma radiation, in which case the symbol k_Q is used in this Code of Practice for the beam quality correction factor. In some PSDLs high-energy photon and electron beams are directly used for calibration purposes and the symbol k_{Q,Q_o} is used in those cases.

Ideally, the beam quality correction factor should be measured directly for each chamber at the same quality as the user beam. However, this is not achievable in most standards laboratories. Such measurements can be performed only in laboratories having access to the appropriate beam qualities. For this reason the technique is at present restricted to a few PSDLs in the world. The procedure requires the availability of an energy-independent dosimetry system, such as a calorimeter, operating at these qualities. A related problem is the difficulty in reproducing in a standards laboratory beam qualities identical to those produced by clinical accelerators [53].

When no experimental data are available, or it is difficult to measure k_{Q,Q_o} directly for realistic clinical beams, in many cases the correction factors can be calculated theoretically. Where Bragg-Gray theory can be applied, an expression for k_{Q,Q_o} can be derived comparing Eq. (3.2) with the $N_{D,air}$ formalism used in the IAEA Codes of Practice TRS-277 [17] and TRS-381 [21] and other dosimetry protocols. A general expression for k_{Q,Q_o} has been given in Refs. [20, 54]

$$k_{Q,Q_o} = \frac{(s_{w,air})_Q (W_{air})_Q P_Q}{(s_{w,air})_{Q_o} (W_{air})_{Q_o} P_{Q_o}} \quad (3.4)$$

which is valid for all types of high-energy beams and includes ratios, at the qualities Q and Q_o , of Spencer-Attix water/air stopping-power ratios, $s_{w,air}$, of the mean energy expended in air per ion pair formed, W_{air} ⁹, and of the perturbation factors p_Q . The overall perturbation factors p_Q and p_{Q_o} include all departures from the ideal Bragg-Gray detector conditions, i.e., p_{wall} , p_{cav} , p_{cel} and p_{dis} . These perturbation factors have been defined in Section 1.6.

In therapeutic electron and photon beams the general assumption of $(W_{air})_Q = (W_{air})_{Q_o}$ ¹⁰ yields the simpler equation for k_{Q,Q_o} [27]

$$k_{Q,Q_o} \approx \frac{(s_{w,air})_Q}{(s_{w,air})_{Q_o}} \frac{p_Q}{p_{Q_o}} \quad (3.5)$$

which depends only on quotients of water to air stopping-power ratios and perturbation factors at the beam qualities Q and Q_o . The only chamber specific factors involved are the perturbation correction factors p_Q and p_{Q_o} . It should be emphasized, however, that when comparing experimental and theoretical determinations of k_{Q,Q_o} it is the full Eq. (3.4) that is relevant, rather than the approximate Eq. (3.5). The possible energy variation of W_{air} , as suggested by some experimental evidence (c.f. Ref. [55]), makes it necessary to use the approximate symbol (\approx) in the latter expression.

When the reference quality Q_o is ⁶⁰Co gamma radiation, values of the product $(s_{w,air})_{Q_o} p_{Q_o}$ in the denominator of Eq. (3.4) are given in Appendix B for cylindrical ionization chambers listed in this Code of Practice. These values have been used in the calculation of all k_{Q,Q_o} factors given in the different Sections of this Code of Practice when they are normalized to ⁶⁰Co; the symbol k_Q is used in those cases.

In the case of low- and medium-energy x-ray beams Bragg-Gray conditions do not apply and therefore Eq. (3.4) cannot be used. In addition, the chamber to chamber variation in response is usually rather large (see Sections 8 and 9). For these radiation qualities the formalism is based exclusively on the use of directly measured $N_{D,w,Q}$ or k_{Q,Q_o} factors for individual user chambers.

3.2.1. A modified k_{Q,Q_o} for electron-beam cross calibrations

For dosimeters that are used in electron beams, when the calibration quality Q_o is ⁶⁰Co, the situation is the same as discussed previously. For a user electron beam quality Q , the beam quality correction factor k_Q is given by Eq. (3.4).

An alternative to this is the direct calibration of chambers in electron beams, although this option has little application at present because of the limited availability of such calibrations. However, the ongoing development of electron-beam primary standards will enable calibration at a series of electron beam qualities. From these calibration factors, a series of measured k_{Q,Q_o} factors may be derived following the procedure given in Section 7.5.2 (the same procedure is used for chambers calibrated directly in high-energy photons and in low- and medium-energy x-rays).

A third possibility, which in the absence of direct calibration in electron beams is the preferred choice, is the cross calibration of a plane-parallel chamber against a calibrated cylindrical chamber in a high-energy electron beam of quality Q_{cross} . The factors $k_{Q,Q_{cross}}$, which allow the subsequent use of

⁹ It should be noticed that W_{air} , as well as $s_{w,air}$, should be averaged over the complete spectra of particles present. This is an important limitation in the case of heavy charged particles, where the determination of all possible particle spectra is a considerable undertaking.

¹⁰ Note that this is the same assumption as for the non-dependence of $N_{D,air}$ on the quality of the beam (see TRS-277 [17]).

this chamber in an electron beam of quality Q , are non-trivial because the cross-calibration quality Q_{cross} is not unique and so for each chamber type a two dimensional table of $k_{Q,Q_{cross}}$ factors is required.

However, it is possible to present the required data in a single table by introducing an arbitrary electron beam quality Q_{int} which acts as an intermediate between the cross calibration quality Q_{cross} and the user quality Q (no measurements are made at Q_{int} , it is a tool to simplify the presentation of the data). The required $k_{Q,Q_{cross}}$ factor is evaluated as the ratio of the factors $k_{Q,Q_{int}}$ and $k_{Q_{cross},Q_{int}}$:

$$k_{Q,Q_{cross}} = \frac{k_{Q,Q_{int}}}{k_{Q_{cross},Q_{int}}} \quad (3.6)$$

The factor $(k_{Q_{cross},Q_{int}})^{-1}$ corrects the actual chamber calibration factor $N_{D,w,Q_{cross}}$ into a calibration factor which applies at the intermediate quality Q_{int} . The factor $k_{Q,Q_{int}}$ corrects this latter calibration factor into one which applies at Q so that the general Eq. (3.2) for $D_{w,Q}$ can be applied.

The expressions for $k_{Q,Q_{int}}$ and $k_{Q_{cross},Q_{int}}$ follow from Eq. (3.5), from which it is clear that the stopping-power ratios and perturbation factors at Q_{int} will cancel in Eq. (3.6). Thus the value chosen for Q_{int} is arbitrary and in the present Code of Practice is chosen as $R_{50} = 7.5 \text{ g cm}^{-2}$, where R_{50} is the beam quality index in electron beams (see Section 7). Values for $k_{Q,Q_{int}}$ and $k_{Q_{cross},Q_{int}}$ calculated on this basis are given in Table 7.IV for a series of chamber types.

The data of Table 7.IV highlight another advantage of this approach. For a given Q and Q_{cross} , the value for $k_{Q,Q_{cross}}$ is the same for all well-guarded plane-parallel chamber types. For cylindrical chamber types it depends only on the chamber radius r_{cyl} . The chosen value for Q_{int} minimizes the differences for cylindrical chambers of different r_{cyl} over the range of beam qualities for which cylindrical chambers are used. This value for Q_{int} ($R_{50} = 7.5 \text{ g cm}^{-2}$) is also consistent with AAPM TG-51 [51] so that the same measured or calculated values for $k_{Q,Q_{int}}$ and $k_{Q_{cross},Q_{int}}$ may be used in Eq. (3.6).

Note that the above method may also be used for plane-parallel or cylindrical chambers calibrated at a standards laboratory at a single electron beam quality Q_o .

3.3. Relation to N_K -based Codes of Practice

The connection between the $N_K - N_{D,air}$ formalism (used for example in TRS-277 [17] and TRS-381 [21]) and the present $N_{D,w}$ formalism is established for high-energy beams by the relationship

$$N_{D,w,Q_o} = N_{D,air}(s_{w,air})_{Q_o} p_{Q_o} \quad (3.7)$$

where Q_o is the reference quality (^{60}Co gamma rays in previous Codes of Practice) and p_{Q_o} the overall perturbation factor given by

$$p_{Q_o} = [p_{dis} p_{wall} p_{cav} p_{cel}]_{Q_o} \quad (3.8)$$

The meaning of the different perturbation factors has been described in Section 1.6, where it was emphasized that p_{cel} refers exclusively to in-phantom measurements and should not be confused with the symbol used in TRS-277 to account for the combined effect of the central electrode in air and in phantom measurements. A similar relationship can be established for low- and medium-energy x-rays. Details on the comparison between the two formalisms are given in Appendix A.

Although the use of a calculated N_{D,w,Q_0} calibration factor is not recommended, this option could be used during an interim period aiming at the practical implementation of this Code of Practice using existing air-kerma calibrations. This will be the most common procedure for kilovoltage x-rays until standards of absorbed dose to water become more widely disseminated. It is emphasized, however, that calculated N_{D,w,Q_0} calibration factors are not traceable to primary standards of absorbed dose to water.

A calculated N_{D,w,Q_0} can also be used to verify that therapy beam calibrations based on the two formalisms, $N_{D,w}$ and N_K , yield approximately the same absorbed dose to water under reference conditions (see Appendix A for details). Should this not be the case, the reasons for the discrepancy should be carefully investigated before switching to the $N_{D,w}$ method.

4. IMPLEMENTATION

4.1. General

Efforts in PSDLs have concentrated on providing calibrations in terms of absorbed dose to water of ionization chambers in ^{60}Co gamma-ray beams, and to a lesser extent in high-energy photon and electron beams [46, 56-59].

Depending on the standards laboratory, users may be provided with N_{D,w,Q_0} calibrations according to different options. These options are clarified here in order to avoid the incorrect use of this Code of Practice:

- (a) The first approach is to provide users with a calibration factor at a reference beam quality Q_0 , usually ^{60}Co . For additional qualities the calibration at the reference quality is supplied together with directly measured beam quality correction factors k_{Q,Q_0} for that particular chamber at specific beam qualities Q . Only laboratories having radiation sources and standards operating at different beam qualities can provide directly measured values of k_{Q,Q_0} for these qualities. The main advantage of this approach is that the individual chamber response in a water phantom irradiated by various beam types and qualities is intrinsically taken into account. A possible limitation, common to option (b) below, resides in the difference between the beam qualities used at the standards laboratory and at the user facility, which is of special relevance for high-energy beams (c.f. Ref. [53]) and whose influence is still the subject of studies at some PSDLs.
- (b) An alternative approach, in practical terms identical to the one described above and differing only in the presentation of the data, is to provide a series of $N_{D,w,Q}$ calibrations of the user ionization chamber at beam qualities Q . There is, however, an advantage in presenting the data by normalizing all calibration factors to a single calibration factor N_{D,w,Q_0} together with directly measured values of k_{Q,Q_0} . Once directly measured values of k_{Q,Q_0} for a particular chamber have been obtained, it may not be necessary for the user to re-calibrate the chamber at all qualities Q , but only at the single reference quality Q_0 . The quality dependence of that chamber can be verified less often by calibration at all qualities¹¹. Furthermore, this single reference quality calibration does not need to be performed at the same laboratory where the k_{Q,Q_0} values were measured (usually a PSDL).
- (c) In the third approach users can be provided with a N_{D,w,Q_0} calibration factor for the ionization chamber, most commonly at the reference quality ^{60}Co , and theoretically derived beam quality correction factors k_{Q,Q_0} for that chamber type which must be applied for other beam qualities. This method ignores chamber-to-chamber variations in response with energy of a given chamber type, and calculations rely on chamber specifications provided by manufacturers.
- (d) A fourth approach, offered by some standards laboratories, is to provide a single measured N_{D,w,Q_0} for a given chamber, obtained at a selected reference quality, together with *generic*¹² experimental values of k_{Q,Q_0} for that ionization chamber type. This option does not take into account possible chamber-to-chamber variations within a given chamber type. Furthermore, there are currently only limited experimental data on k_{Q,Q_0} for most commercial chambers. This approach has much in common with option (c) above and, if for a given chamber type, the

¹¹ See Section 4.3 for recommendations on the frequency of dosimeter calibrations.

¹² In the present context, *generic* stands for factors common to a specific ionization chamber type, supplied by a given manufacturer.

theoretical values of k_{Q,Q_0} are verified experimentally in a standards laboratory for a large sample of chambers, the theoretical values of k_{Q,Q_0} can be assumed to correspond to a mean value.

Based on these descriptions, the following recommendations are given for compliance with this Code of Practice:

- (1) Approach (a), or its equivalent (b), are the preferred alternatives, although it is acknowledged that for beam qualities other than ^{60}Co such possibilities are at present restricted to a few PSDLs.
- (2) Approach (c) is recommended for those users who do not have access to k_Q or k_{Q,Q_0} values directly measured at various beam qualities in a standards laboratory. The use of ^{60}Co as the reference quality for determining $N_{D,w}$ is particularly appropriate for SSDLs, where the possibility of having an accelerator is remote. This approach is the most common practice today and favours the use of theoretical k_Q factors (i.e. k_{Q,Q_0} with ^{60}Co used as Q_0) determined according to Eqs. (3.4) or (3.5).
- (3) Approach (d) is an alternative option to (c) only when k_Q or k_{Q,Q_0} values have been obtained by a standards laboratory from a large sample of ionization chambers and the standard deviation of chamber-to-chamber differences is small. This is usually the case for Secondary Standard quality chambers (see IEC 60731 [7]) such as those measured by the NPL (U.K.), see Fig. 4.1. Generic experimental k_Q or k_{Q,Q_0} values not determined by a standards laboratory are not recommended.
- (4) Low- and medium-energy x-ray dosimetry must be based on approaches (a) or (b) with the range of values of Q chosen to be as similar as possible to the qualities of the beams that will be used clinically.
- (5) As long as there are restricted possibilities for establishing experimental $N_{D,w,Q}$ factors by standards laboratories in proton and heavy-ion beams the theoretical approach (c) is the only recommendation to be used for such beams.

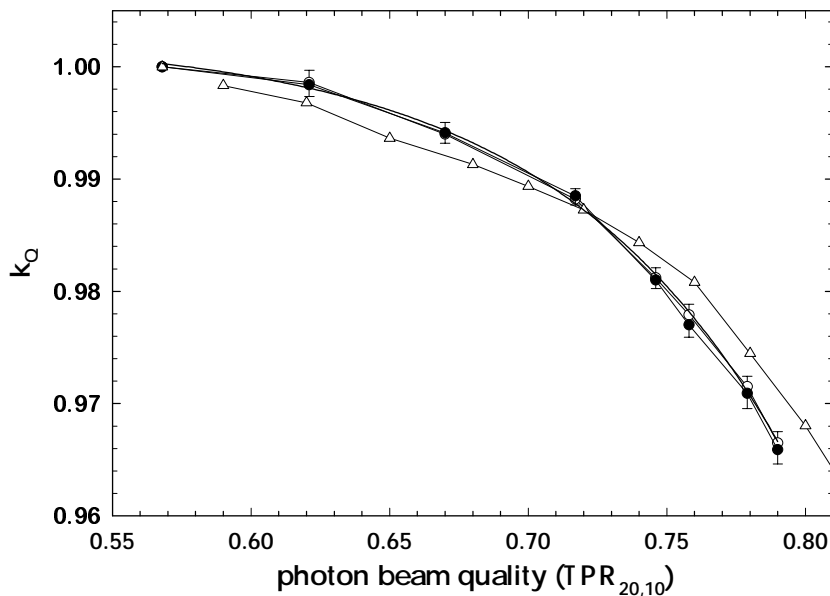

Fig. 4.1. Mean values of k_Q at various photon beam qualities measured at the NPL for Secondary Standard ionization chambers of the type NE 2561 (open circles) and NE 2611 (filled circles) [60]. The solid line is a sigmoidal fit to the experimental data. The uncertainty bars represent chamber to chamber variations, determined as the standard deviations of samples of 13 NE 2561 (upper half) and 11 NE 2611 (lower half) chambers. The values of k_Q are normalized to a $\text{TPR}_{20,10}$ of 0.568 (^{60}Co beam at the NPL). Calculated values of k_Q for these chambers given in Table 6.III are included for comparison (triangles); note that the calculated values do not distinguish between the two types of chamber.

4.2. Equipment

Only ionometric measurements are considered in the present Code of Practice for reference dosimetry. The requirements on equipment follow closely those in TRS-277 [17] and TRS-381 [21], as well as the IEC Standard 60731 [7] for dosimeters with ionization chambers. The use of these documents, although developed for photon and electron radiation, can be extended to the other types of radiation fields included in this Code of Practice. The present Section provides only general requirements on equipment; specific details on instrumentation that apply to each radiation type will be discussed in the relevant Section.

An ionometric dosimeter system for radiotherapy contains the following components:

- (a) one or more ionization chamber assemblies, which include the electrical fitting and any permanently attached cable, intended for different purposes (e.g. different radiation qualities),
- (b) a measuring assembly (electrometer), often separately calibrated in terms of charge or current per scale division,
- (c) one or more phantoms with waterproof sleeves.
- (d) The dosimeter system should also include one or more stability check devices.

4.2.1. Ionization chambers

A cylindrical ionization chamber type may be used for the calibration of radiotherapy beams of medium-energy x-rays above 80 kV and an HVL of 2 mm aluminium, ^{60}Co gamma radiation, high-energy photon beams, electron beams with energy above 10 MeV approximately, and therapeutic proton and heavy-ion beams. This type of chamber is very convenient for measurements at these radiation qualities as it is robust and simple to use for measurements in a water phantom. The chamber cavity volume should be between about 0.1 cm^3 and 1 cm^3 . This size range is a compromise between the need for sufficient sensitivity and the ability to measure dose at a point. These requirements are met in cylindrical chambers with an air cavity of internal diameter not greater than around 7 mm and an internal length not greater than around 25 mm. In use, the chamber must be aligned in such a way that the radiation fluence is approximately uniform over the cross-section of the chamber cavity. The cavity length therefore sets a lower limit on the size of the field in which measurements may be made.

The construction of the chamber should be as homogeneous as possible but it is recognized that for technical reasons the central electrode is likely to be of a material different from that of the walls. Indeed the choice of materials may play an important role in ensuring that the energy response of the chamber does not vary considerably. It is also necessary for the air cavity not to be sealed; it should be designed so that it will equilibrate rapidly with the ambient temperature and air pressure.

In choosing a cylindrical ionization chamber the user should pay attention as to whether it is to be used as a reference instrument (calibrated at a standards laboratory and used for beam calibration in the user beam) or as a field instrument (cross-calibrated against a reference chamber and normally used for routine measurements). Graphite-walled ionization chambers usually have better long-term stability and more uniform response than plastic-walled chambers; however, the latter are more robust and therefore more suitable for routine measurements. Humid air may, on the other hand, affect the chamber response, especially for chambers with Nylon or A-150 walls [61]. As an ionization chamber is an instrument of high precision, attention should be paid to acquiring a chamber type whose performance has been sufficiently tested in radiotherapy beams. Characteristics of certain cylindrical ionization chambers are given in Table 4.I.

The use of plane-parallel ionization chambers in high-energy electron and photon beams has been described in detail in TRS-381 [21]. Plane-parallel chambers are recommended to be used at all

electron energies, and below 10 MeV their use is mandatory. For photon beams, they are suitable for reference dosimetry measurements only when a calibration in terms of absorbed dose to water is available at the user quality. They are also suitable for reference dosimetry for proton and heavy ion beams, specially for beams having narrow SOBP. The chamber should preferably be designed for use in water and the construction should be as homogeneous and water-equivalent as possible. It is especially important to be aware of backscatter effects from the rear wall of the chamber. Chambers designed for measurements in solid phantoms should accordingly be as phantom equivalent as possible. Some chambers have, however, a design that includes several materials, resulting in a significant departure from homogeneity. In these cases there is no simple rule for the selection of chamber type and phantom material.

One of the main advantages of plane-parallel chambers for electron beam dosimetry is the possibility of minimizing scattering perturbation effects. Plane-parallel ionization chambers may be designed so that the chamber samples the electron fluence incident through the front window, the contribution of electrons entering through the side walls being negligible. This design justifies taking the effective point of measurement of the chamber, P_{eff} , to be on the inner surface of the entrance window, at the centre of the window for all beam qualities and depths. For practical purposes it is therefore convenient to choose the reference point of the chamber at the same position. In order to fulfil, within a reasonable approximation, the requirements concerning scattering perturbation effects and P_{eff} , plane-parallel chambers must have a “pancake” or disc-shaped cavity in which the ratio of cavity diameter to the cavity height should be large (preferably 5 or more). Furthermore, the diameter of the collecting electrode should not exceed 20 mm in order to reduce the influence of radial non-uniformities of the beam profile. The cavity height should not exceed 2 mm, and the collecting electrode should be surrounded by a guard electrode having a width not smaller than 1.5 times the cavity height. In addition, the thickness of the front window should be restricted to 0.1 g cm⁻² (or 1 mm of PMMA) at most, to make measurements at shallow depths possible. It is also necessary for the air cavity to be vented so that it will equilibrate rapidly with the ambient temperature and air pressure. Characteristics of certain plane-parallel ionization chambers for electron beam dosimetry are given in Table 4.II. These chambers can also be used for relative dosimetry in photon beams (c.f. TRS-381 [21]), therapeutic proton beams, and heavy-ion beams.

Ionization chambers for measuring low-energy x-rays must also be of the plane-parallel type. The chamber must have an entrance window consisting of a thin membrane of thickness in the range 2-3 mg cm⁻². When used in beams above 50 kV the chamber may need to have an additional plastic foil added to the window to provide full build-up of the primary beam and filter out secondary electrons generated in beam-limiting devices (see Table 8.I). In use, the chamber is mounted with the window flush with the surface of a phantom. The phantom and build-up foils need to be supplied together with the chamber when it is sent for calibration. In order to minimize the dependence of the chamber response on the shape of the x-ray spectrum, the response should vary by less than 5% over the energy range used. Characteristics of certain plane-parallel ionization chambers used for x-ray dosimetry at low energy are given in Table 4.III.

TABLE 4.1. CHARACTERISTICS OF CYLINDRICAL IONIZATION CHAMBER TYPES (as stated by manufacturers).

Ionization chamber type ^a	Cavity volume (cm ³)	Cavity length (mm)	Cavity radius (mm)	Wall material	Wall thickness (g cm ⁻²)	Build-up cap material ^{b,c}	Build-up cap thickness ^{b,c} (g cm ⁻²)	Central electrode material ^c	Waterproof
Capintec PR-05P mini	0.07	5.5	2.0	C-552	0.220	polystyrene	0.568	C-552	N
Capintec PR-05 mini	0.14	11.5	2.0	C-552	0.220	polystyrene	0.568	C-552	N
Capintec PR-06C/G Farmer	0.65	22.0	3.2	C-552	0.050	C-552	0.924	C-552	N
Capintec PR-06C/G Farmer	0.65	22.0	3.2	C-552	0.050	polystyrene	0.537	C-552	N
Capintec PR-06C/G Farmer	0.65	22.0	3.2	C-552	0.050	PMMA ^d	0.547	C-552	N
Exradin A2 Spokas (2 mm cap)	0.53	11.4	4.8	C-552	0.176	C-552	0.352	C-552	Y
Exradin T2 Spokas (4 mm cap)	0.53	11.4	4.8	A-150	0.113	A-150	0.451	A-150	Y
Exradin A1 mini Shonka (2 mm cap)	0.05	5.7	2.0	C-552	0.176	C-552	0.352	C-552	Y
Exradin T1 mini Shonka (4 mm cap)	0.05	5.7	2.0	A-150	0.113	A-150	0.451	A-150	Y
Exradin A12 Farmer	0.65	24.2	3.1	C-552	0.088	C-552	0.493	C-552	Y
Far West Tech IC-18	0.1	9.5	2.3	A-150	0.183	A-150	0.386	A-150	N
FZH TK 01	0.4	12.0	3.5	Delrin	0.071	Delrin	0.430		Y
Nuclear Assoc 30-750	0.03	3.6	2.0	C-552	0.068			C-552	Y
Nuclear Assoc 30-749	0.08	4.0	3.0	C-552	0.068			C-552	Y
Nuclear Assoc 30-744	0.13	5.8	3.0	C-552	0.068			C-552	Y
Nuclear Assoc 30-716	0.25	10.0	3.0	C-552	0.068			C-552	Y
Nuclear Assoc 30-753 Farmer shortened	0.25	9.0	3.1	C-552	0.068	Delrin	0.560	C-552	Y
Nuclear Assoc 30-751 Farmer	0.69	23.0	3.1	Delrin	0.056	Delrin	0.560	aluminium	Y
Nuclear Assoc 30-752 Farmer	0.69	23.0	3.1	graphite	0.072	Delrin	0.560	aluminium	Y
NE 2515	0.2	7.0	3.0	Tufnol	0.074	PMMA	0.543	aluminium	N
NE 2515/3	0.2	7.0	3.2	graphite	0.066	PMMA	0.543	aluminium	N
NE 2577	0.2	8.3	3.2	graphite	0.066	Delrin	0.552	aluminium	N
NE 2505 Farmer	0.6	24.0	3.0	Tufnol	0.075	PMMA	0.545	aluminium	N
NE 2505/A Farmer	0.6	24.0	3.0	nylon 66	0.063	PMMA	0.545	aluminium	N
NE 2505/3, 3A Farmer	0.6	24.0	3.2	graphite	0.065	PMMA	0.551	aluminium	N
NE 2505/3, 3B Farmer	0.6	24.0	3.2	nylon 66	0.041	PMMA	0.551	aluminium	N
NE 2571 Farmer	0.6	24.0	3.2	graphite	0.065	Delrin	0.551	aluminium	N
NE 2581 Farmer (PMMA cap)	0.6	24.0	3.2	A-150	0.041	PMMA	0.584	A-150	N
NE 2581 Farmer (polystyrene cap)	0.6	24.0	3.2	A-150	0.041	polystyrene	0.584	A-150	N
NE 2561/ 2611 Sec Std	0.33	9.2	3.7	graphite	0.090	Delrin	0.600	aluminium (hollow)	N
PTW 23323 micro	0.1	12.0	1.6	PMMA ^e	0.197	PMMA	0.357	aluminium	Y
PTW 23331 rigid	1.0	22.0	4.0	PMMA ^e	0.060	PMMA	0.345	aluminium	N
PTW 23332 rigid	0.3	18.0	2.5	PMMA ^e	0.054	PMMA	0.357	aluminium	N

Ionization chamber type ^a	Cavity volume (cm ³)	Cavity length (mm)	Cavity radius (mm)	Wall material	Wall thickness (g cm ⁻²)	Build-up cap material ^{b,c}	Build-up cap thickness ^{b,c} (g cm ⁻²)	Central electrode material ^c	Waterproof
PTW 23333 (3 mm cap)	0.6	21.9	3.1	PMMA ^e	0.059	PMMA	0.356	aluminium	N
PTW 23333 (4.6 mm cap)	0.6	21.9	3.1	PMMA ^e	0.053	PMMA	0.551	aluminium	N
PTW 30001 Farmer	0.6	23.0	3.1	PMMA ^e	0.045	PMMA	0.541	aluminium	N
PTW 30010 Farmer	0.6	23.0	3.1	PMMA ^e	0.057	PMMA	0.541	aluminium	N
PTW 30002/30011 Farmer	0.6	23.0	3.1	graphite	0.079	PMMA	0.541	graphite	N
PTW 30004/30012 Farmer	0.6	23.0	3.1	graphite	0.079	PMMA	0.541	aluminium	N
PTW 30006/30013 Farmer	0.6	23.0	3.1	PMMA ^e	0.057	PMMA	0.541	aluminium	Y
PTW 31002 flexible	0.13	6.5	2.8	PMMA ^e	0.078	PMMA	0.357	aluminium	Y
PTW 31003 flexible	0.3	16.3	2.8	PMMA ^e	0.078	PMMA	0.357	aluminium	Y
SNC 100730 Farmer	0.6	24.4	3.5	PMMA	0.060	PMMA	0.536	aluminium	N
SNC 100740 Farmer	0.6	24.4	3.5	graphite	0.085	PMMA	0.536	aluminium	N
Victoreen Radocon III 550	0.3	4.3	2.5	Delrin	0.529		0.536		N
Victoreen Radocon II 555	0.1	23.0	2.4	polystyrene	0.117	PMMA	0.481		N
Victoreen 30-348	0.3	18.0	2.5	PMMA	0.060	PMMA	0.360		N
Victoreen 30-351	0.6	23.0	3.1	PMMA	0.060	PMMA	0.360		N
Victoreen 30-349	1.0	22.0	4.0	PMMA	0.060	PMMA	0.360		N
Victoreen 30-361	0.4	22.3	2.4	PMMA	0.144	PMMA	0.360		N
Scdx-Wellhöfer IC 05	0.08	4.0	3.0	C-552	0.068			C-552	Y
Scdx-Wellhöfer IC 06	0.08	4.0	3.0	C-552	0.068			C-552	Y
Scdx-Wellhöfer IC 10	0.14	6.3	3.0	C-552	0.068			C-552	Y
Scdx-Wellhöfer IC 15	0.13	5.8	3.0	C-552	0.068			C-552	Y
Scdx-Wellhöfer IC 25	0.25	10.0	3.0	C-552	0.068			C-552	Y
Scdx-Wellhöfer IC 28 Farmer shortened	0.3	9.0	3.1	C-552	0.068	POM ^f	0.560	C-552	Y
Scdx-Wellhöfer IC 69 Farmer	0.67	23.0	3.1	Delrin	0.056	POM	0.560	aluminium	Y
Scdx-Wellhöfer IC 70 Farmer	0.67	23.0	3.1	graphite	0.068	POM	0.560	aluminium	Y

^a Some of the chambers listed in this Table fail to meet the minimum requirements described in Section 4.2.1. However, they have been included because of their current clinical use.

^b For dose determinations based on standards of absorbed dose to water, the information related to the build-up cap of an ionization chamber is not relevant. It is given here to enable comparisons with previous formalisms based on standards of air kerma.

^c Blanks correspond to no information available.

^d Polymethyl Methacrylate (C₅H₈O₂), also known as acrylic. Trade names are *Lucite*, *Plexiglas* or *Perspex*.

^e Like most chamber types with non-conductive plastic walls, the chamber wall has an inner conductive layer made of graphite. For this chamber type, the thickness and density of the graphite layer is supplied in the chamber specifications.

^f Poly Oxy Methylene (CH₂O). A trade name is *Delrin*.

TABLE 4.II. CHARACTERISTICS OF PLANE-PARALLEL CHAMBER TYPES (Adapted from TRS-381 [21])

Ionization chamber type ^a	Materials	Window thickness	Electrode spacing	Collecting electrode diameter	Guard ring width	Recommended phantom material
NACP01 (Scanditronix).	graphite window, graphited rexolite electrode	90 mg cm ⁻²	2 mm	10 mm	3 mm	polystyrene graphite
Calcam-1 (Dosetek)	graphite body (back wall) rexolite housing	0.5 mm				water (with water-proof housing)
NACP02 (Scanditronix).	mylar foil and graphite window graphited rexolite electrode	104 mg cm ⁻²	2 mm	10 mm	3 mm	water, PMMA
Calcam-2 (Dosetek)	graphite body (back wall) rexolite housing	0.6 mm				
Markus chamber PTW 23343	graphited polyethylene foil window graphited polystyrene collector	102 mg cm ⁻²	2 mm	5.3 mm	0.2 mm	water, PMMA
NA 30-329	PMMA body, PMMA cap	0.9 mm (incl. cap)				
NE 2534						
Scdx-Wellhöfer PPC 05	window and body C 552 graphited (PEEK ^b) electrode	176 mg cm ⁻²	0.5 mm	10 mm	3.5 mm	water
Holt chamber (Memorial) NA 30-404	graphited polystyrene wall and electrode, polystyrene body	416 mg cm ⁻²	2 mm	25 mm	5 mm	polystyrene (phantom integr.)
Capintec PS-033	aluminized mylar foil window carbon-impregnated air-equivalent plastic electrode, polystyrene body	0.5 mg cm ⁻²	2.4 mm	16.2 mm	2.5 mm	polystyrene
Exradin 11	conducting plastic wall and electrodes model P11: polystyrene equivalent model A11: C552, air equivalent model T11: A150, tissue equivalent	P11: 104 mg cm ⁻² 1 mm	2 mm	20 mm	5.1 mm	P11: polystyrene water
Roos-type chamber PTB FK6	PMMA graphited electrodes	118 mg cm ⁻²	2 mm	16 mm	4 mm	water PMMA
PTW 34001		1 mm				
Scdx-Wellhöfer PPC 35						
Scdx-Wellhöfer PPC 40						
Attix chamber RMI 449	Kapton conductive film window, graphited polyethylene collector solid water body	4.8 mg cm ⁻²	1 mm	12.7 mm	13.5 mm	solid water
		0.025 mm	(0.7 mm reported)			

^a Some of the chambers listed in this Table fail to meet the minimum requirements described in Section 4.2.1. However, they have been included because of their current clinical use.

^b Polyetheretherketone (C₁₉H₁₈O₃) 1.265 g cm⁻³

TABLE 4.III. CHARACTERISTICS OF PLANE-PARALLEL IONIZATION CHAMBERS USED FOR X-RAY DOSIMETRY AT LOW ENERGY

Ionization chamber type	Cavity volume (cm ³)	Collecting electrode diameter (mm)	Window material	Window thickness (mg cm ⁻²)
PTW M23342	0.02	3	polyethylene	2.5
PTW M23344	0.20	13	polyethylene	2.5
NE 2532/3A	0.03	3	polyethylene	2.3
NE 2536/3A	0.30	13	polyethylene	2.3

4.2.2. Measuring assembly

The measuring assembly for the measurement of current (or charge) includes an electrometer and a power supply for the polarizing voltage of the ionization chamber. The electrometer should preferably have a digital display and should be capable of four-digit resolution (i.e. 0.1% resolution on the reading). The variation in the response should not exceed $\pm 0.5\%$ over 1 year (long-term stability).

The electrometer and the ionization chamber may be calibrated separately. This is particularly useful in centres which have several electrometers and/or chambers. In some cases, however, the electrometer is an integral part of the dosimeter and the ionization chamber and electrometer are calibrated as a single unit.

It should be possible to reverse the polarity of the polarizing voltage, so that the polarity effect of the ionization chamber may be determined, and to vary the voltage in order to determine the collection efficiency as described in Section 4.4.3.4.

4.2.3. Phantoms

Water is recommended in the IAEA Codes of Practice TRS-277 [17] and TRS-381 [21] as the reference medium for measurements of absorbed dose for both photon and electron beams and the same is recommended in this Code of Practice. The phantom should extend to at least 5 cm beyond all four sides of the largest field size employed at the depth of measurement. There should also be a margin of at least 5 g cm⁻² beyond the maximum depth of measurement except for medium-energy x-rays in which case it should extend to at least 10 g cm⁻².

Solid phantoms in slab form such as polystyrene, PMMA, and certain water-equivalent plastics such as *Solid Water*, *Plastic Water*, *Virtual Water*, etc (see ICRU 44 [62] and Ref. [63]) may be used for low-energy electron beam dosimetry (below approximately 10 MeV, see Section 7.8) and are generally required for low-energy x-rays. Nevertheless, the dose determination must always be referred to the absorbed dose to water at the reference depth in a homogeneous water phantom. Ideally, the phantom material should be water-equivalent, that is, have the same absorption and scatter properties as water. The elemental composition (in fraction by weight), nominal density and mean atomic number of some common phantom materials used as water substitutes are given in Table 4.IV.

In spite of their increasing popularity, the use of plastic phantoms is strongly discouraged for reference measurements (except for low-energy x-rays), as in general they are responsible for the largest discrepancies in the determination of absorbed dose for most beam types. This is mainly due to density variations between different batches and to the approximate nature of the procedures for scaling depths and absorbed dose (or fluence) from plastic to water. The density of the plastic should be measured for the batch of plastic in use rather than using a nominal value for the plastic type as supplied by the manufacturer, since density differences of up to 4% have been reported (see for example Ref. [64]). The commissioning of plastic phantoms in slab form should include a

determination of the mean thickness and density of each slab, as well as the variation in thickness over a single slab and an investigation by radiograph for bubbles or voids in the plastic.

Although not recommended for use in reference dosimetry, plastic phantoms can be used for routine quality assurance measurements, provided the relationship between dosimeter readings in plastic and water has been established for the user beam at the time of calibration. This will involve a careful comparison with measurements in water, which should be performed prior to the routine use of the phantom, and periodic checks at reasonable intervals might be also needed to assure the validity and consistency of the original comparison result [64].

When phantoms of insulating materials are adopted, users must be aware of the problems that may result from charge storage. This is of particular concern if a thimble-type chamber is used in a plastic phantom to measure in electron beams, which is not recommended in this Code of Practice. However, charge storage may also have a significant effect during electron beam calibration using plane-parallel chambers. The effect may cause a very high electric field strength around the chamber, directly influencing the electron fluence distribution and therefore affecting the reading of the chamber. In order to minimize this effect the phantom should be constructed using thin slabs of plastic, in no case exceeding 2 cm [17, 65]. As noted above, the actual thickness of each slab, and the variation of the thickness over the slab area, should be measured, particularly in the case of thin slabs. The mean density of each slab should also be determined. Furthermore, care must be taken to ensure that air layers between the slabs are avoided.

TABLE 4.IV. ELEMENTAL COMPOSITION (FRACTION BY WEIGHT), NOMINAL DENSITY AND MEAN ATOMIC NUMBER OF COMMON PHANTOM MATERIALS USED AS WATER SUBSTITUTES (For comparison, liquid water is also included)

	Liquid water ^a	Solid Water WT1 ^a	Solid Water RMI-457	Plastic Water	Virtual Water	PMMA ^{a, b}	Polystyrene ^a	Tissue-equivalent plastic A-150 ^a
H	0.1119	0.0810	0.0809	0.0925	0.0770	0.0805	0.0774	0.1013
C		0.6720	0.6722	0.6282	0.6874	0.5998	0.9226	0.7755
N		0.0240	0.0240	0.0100	0.0227			0.0351
O	0.8881	0.1990	0.1984	0.1794	0.1886	0.3196		0.0523
F								0.0174
Cl		0.0010	0.0013	0.0096	0.0013			
Ca		0.0230	0.0232	0.0795	0.0231			0.0184
Br				0.0003				
Density (g cm ⁻³)	1.000	1.020	1.030	1.013	1.030	1.190	1.060	1.127
\bar{Z} ^c	6.6	5.95	5.96	6.62	5.97	5.85	5.29	5.49

^a See ICRU Reports 37 [66] and 44 [62].

^b Polymethyl Methacrylate, also known as acrylic. Trade names are *Lucite*, *Plexiglas* or *Perspex*.

^c For the definition of mean atomic number see, for instance, ICRU Report 35 [11] or TRS-381 [21].

4.2.4. Waterproof sleeve for the chamber

Unless the ionization chamber is designed so that it can be put directly into water, it must be used with a waterproof sleeve. The following recommendations have been adapted from those given in TRS-374 [33]. The sleeve should be made of PMMA, with a wall sufficiently thin (preferably not greater than 1.0 mm in thickness) to allow the chamber to achieve thermal equilibrium with the water in less than 10 min. The sleeve should be designed so as to allow the air pressure in the chamber to reach ambient air pressure quickly; an air gap of 0.1 mm to 0.3 mm between the chamber and the sleeve is adequate. In order to reduce the build-up of water vapour around the chamber, a waterproof sleeve should not be left in water longer than is necessary to carry out the measurements. Additional

accuracy is gained if the same sleeve that was used for the calibration of a chamber in the standards laboratory is also used for all subsequent measurements.

For ionization chambers which are waterproof, the use of a PMMA sleeve may still be a desirable option for positioning the chamber accurately at a given depth, although this depends on the positioning equipment used. Measurements at the IAEA Dosimetry Laboratory with a waterproof Farmer-type chamber PTW W-30006 have not shown significant variations in $N_{D,w}$ when the chamber was calibrated with and without PMMA sleeves up to 1 mm in thickness. This chamber type may therefore be calibrated with or without a sleeve and may be used subsequently in the way that best suits the conditions at the hospital. For other waterproof chamber types similar measurements should be conducted at a standards laboratory prior to adopting such a procedure.

The use of a thin rubber sheath is not recommended, especially for a reference chamber; there is a greater risk of leakage and such a sheath restricts pressure equilibration of the air in the chamber. Moreover, manufacturers usually coat the inner surface of rubber sheaths with a fine powder; this can find its way into the chamber cavity and affect the chamber response, particularly for low- and medium-energy x-rays [67].

4.2.5. Positioning of ionization chambers at the reference depth

In positioning a chamber at the reference depth in water, z_{ref} (expressed in g cm^{-2}), the perturbing effects of the chamber cavity and wall, and the waterproof sleeve or cover must be considered. When the user quality Q is the same as the calibration quality Q_o , or when measured k_{Q,Q_o} values are used, these effects are accounted for in the chamber calibration and it normally suffices to position the chamber at the same depth as at calibration (an exception is when a waterproof sleeve or cover of significantly different thickness is used at chamber calibration and at the user quality). This is one of the important advantages of calibrations in terms of absorbed dose to water.

When no direct calibration at the user quality is available, calculated values for k_{Q,Q_o} must be used. In this case, certain perturbing effects are accounted for in the k_{Q,Q_o} values and others must be accounted for in the positioning of the chamber. Account must also be taken of the effect of any phantom window. These considerations are discussed below. The term *water-equivalent thickness* (in g cm^{-2}) refers to the product of the actual thickness (in cm) and the material density (in g cm^{-3}).

Note that in clinical use it may be more practical to position chambers at a precisely known depth which is within a mm or so of the reference depth, and to correct the result to z_{ref} using the depth-dose distribution of the user beam, rather than attempting to position a chamber to a fraction of a mm.

Note also the term *reference point of the chamber* is used below and in the specification of reference conditions in each Section. For cylindrical chamber types this refers to the centre of the cavity volume of the chamber on the chamber axis¹³ and for plane-parallel chamber types (other than in low-energy x-rays) it refers to the inner surface of the entrance window, at the centre of the window. For plane-parallel chamber types used in low-energy x-rays it refers to the centre of the outer surface of the chamber window (or any build-up foils used).

4.2.5.1. Chamber cavity effects

Two effects arise from the chamber cavity. The perturbation by the cavity of the electron fluence entering the cavity is accounted for by the factor p_{cav} included in calculated k_{Q,Q_o} factors. However, a chamber positioned with its cavity centre at z_{ref} does not sample the electron fluence present at z_{ref} in the undisturbed phantom. This may be accounted for either by applying a displacement correction

¹³ The centre of the cavity volume should be taken to be that point on the chamber axis which is a given distance, as stated by the manufacturer, from the tip of the chamber (measured without build-up cap). For example, for the NE 2561 and NE 2611A chamber types it is 5 mm from the tip and for the NE 2571 Farmer-type chamber it is 13 mm from the tip.

factor p_{dis} in the calculation of k_{Q,Q_o} , or by displacing the chamber by an amount which compensates for this effect (often referred to as the use of the effective point of measurement [17]). For plane-parallel chamber types, the chamber reference point is defined to be at the effective point of measurement; when this is placed at z_{ref} no displacement correction factor p_{dis} is required.

For cylindrical chamber types the method used depends on the radiation modality and this is specified in the reference conditions in each Section. In ^{60}Co , high-energy photon beams and proton beams, the chamber centre is positioned at z_{ref} and values for p_{dis} are used in the calculation of k_{Q,Q_o} . In electron beams and in heavy-ion beams, this method of positioning is not recommended because of the steep dose gradients involved and cylindrical chambers are positioned with the centre displaced from z_{ref} . For electron beams the chamber centre is positioned $0.5 r_{cyl}$ deeper than z_{ref} , where r_{cyl} is the internal radius of the chamber cavity. For heavy-ion beams, a shift of $0.75 r_{cyl}$ is recommended.

4.2.5.2. Chamber wall effects

The factor p_{wall} included in calculated k_{Q,Q_o} factors corrects for the different radiation response of the chamber wall material from that of the phantom material. However, p_{wall} does not include the effect of the different attenuation of the primary fluence by the chamber wall compared with the same thickness of phantom material. When the calibration quality Q_o and the user quality Q are the same, this attenuation is accounted for in the calibration of the chamber. Even when Q_o is not the same as Q , the wall attenuation in photon beams is sufficiently small that cancellation may be assumed. On the other hand, in charged particle beams, the attenuation due to the chamber wall can be significantly different from that due to the same thickness of phantom material, and strictly, the water-equivalent thickness of the chamber wall should be taken into account when calculating where to position the chamber. In practice, for the wall thicknesses normally encountered the required adjustment is small and may be neglected.

4.2.5.3. Chamber waterproofing

Waterproofing sleeves or covers are treated in a similar manner to the chamber wall; in fact, if the same (or very similar) sleeve or cover is used at calibration and in the user beam then it may be considered as part of the chamber wall and treated accordingly. This is the approach recommended in this Code of Practice. However, if a significantly different sleeve or cover is used, the *difference* in the water-equivalent thicknesses must be taken into account in positioning the chamber at z_{ref} , for all modalities.

4.2.5.4. Phantom window

For all modalities, when a horizontal beam is used, the water-equivalent thickness of the phantom window should be taken into account. Note also that thin windows may be subject to an outward bowing due to the water pressure on the inner surface. This effect may occur as soon as the phantom is filled and can increase gradually over the next few hours. Any such effect increases the amount of water in front of a chamber and should also be accounted for in the positioning of the chamber at z_{ref} , particularly for medium-energy x-rays and low-energy electron beams.

4.3. Calibration of ionization chambers

When an ionization chamber or dosimeter is sent to a standards laboratory for calibration, stability check measurements (using a suitable check device) should be done by the user before and after the calibration. This will ensure that the chamber response has not been affected by the transportation. A reference ionization chamber should be calibrated at a reference quality Q_o at intervals not exceeding two or three years or whenever the user suspects that the chamber has been damaged. If directly measured values of k_{Q,Q_o} (or $N_{D,w,Q}$) for the chamber have been obtained previously, a re-calibration to verify the quality dependence of the chamber should be made at least every third time that the chamber is calibrated. This procedure should not be repeated more than twice in succession; the

chamber should be re-calibrated at all qualities at least every six years. However, because of the particular susceptibility of ionization chambers to change in energy response in low- and medium-energy x-rays, it is preferable that chambers used for these beams are re-calibrated at all relevant qualities each time. It is the responsibility of the user to increase the frequency of the calibrations for chambers whose long-term stability has not been verified over a period exceeding five years.

4.3.1. Calibration in a ^{60}Co beam

Calibrations may be carried out either directly against a primary standard of absorbed dose to water at a PSDL or, more commonly, against a secondary standard at an SSDL. Only the latter case will be discussed here¹⁴.

It is assumed that the absorbed dose to water, D_w , is known at a depth of 5 g cm^{-2} in a water phantom for ^{60}Co gamma rays. This is realized at the SSDL by means of a calibrated cavity ionization chamber, performing measurements in a water phantom. The user chamber is placed with its reference point at a depth of 5 g cm^{-2} in a water phantom and its calibration factor $N_{D,w}$ is obtained from

$$N_{D,w} = \frac{D_w}{M} \quad (4.1)$$

where M is the dosimeter reading corrected for influence quantities, in order to correspond to the reference conditions for which the calibration factor is valid. Reference conditions recommended for the calibration of ionization chambers in ^{60}Co are given in Table 4.V.

4.3.2. Calibration in kilovoltage x-rays

As noted in Section 4.1 a chamber used to measure medium- or low-energy x-rays must be calibrated in beams of similar quality to the beams that will be measured. At the time of writing this Code of Practice, only one PSDL has primary standards of absorbed dose to water for kilovoltage x-ray qualities [45]. However it is possible to derive calibration factors in terms of absorbed dose to water from air-kerma calibration factors using one of the accepted protocols or Codes of Practice for the dosimetry of x-ray beams (see Appendix A.2). Thus any calibration laboratory with standards of air kerma can in this way provide derived calibration factors in terms of absorbed dose to water. Even though this is formally equivalent to the user obtaining an air-kerma calibration factor and applying the same air-kerma Code of Practice, it has the advantage of permitting the widespread use of the unified methodology presented here, in a field of dosimetry where standard methods are notably lacking.

There is the possibility that there will be some inconsistency from one calibration laboratory to another, depending on which Code of Practice is used to derive the calibration factors in terms of absorbed dose to water. But this clearly will not add to the inconsistency that already exists in clinical kilovoltage dosimetry because of the use of the differing dosimetry protocols and Codes of Practice. Any laboratory offering derived calibrations must document fully how the derivation was obtained, in order that differences may be resolved if necessary, and to maintain traceability to the original air-kerma primary standards.

Because of the variety of auxiliary dosimetry equipment such as phantoms, waterproofing sleeves, and build-up foils, and the variety of field sizes and SSDs that will be clinically relevant, it is important that the clinical measurement conditions are reproduced as closely as possible in the calibration process. When a chamber is sent for calibration, all relevant auxiliary equipment should be supplied as well, and the details of the clinical beams in which it will be used clearly specified.

¹⁴ General guidelines for the calibration of radiotherapy dosimeters in standards laboratories have been given in numerous publications; among them, the manual IAEA TRS-374 [33] is strongly recommended as a valuable source of information.

Typical reference conditions for the calibration of ionization chambers in kilovoltage x-ray beams are given in Table 4.VI.

TABLE 4.V. REFERENCE CONDITIONS RECOMMENDED FOR THE CALIBRATION OF IONIZATION CHAMBERS IN ^{60}Co GAMMA RADIATION IN STANDARDS LABORATORIES

Influence quantity	Reference value or reference characteristic
Phantom material	water
Phantom size	30 cm x 30 cm x 30 cm (approximately)
Source-chamber distance (SCD) ^a	100 cm
Air temperature ^b	20 °C ^c
Air pressure	101.3 kPa
Reference point of the ionization chamber	for cylindrical chambers, on the chamber axis at the centre of the cavity volume; for plane-parallel chambers on the inner surface of the entrance window, at the centre of the window
Depth in phantom of the reference point of the chamber ^a	5 g cm ⁻²
Field size at the position of the reference point of the chamber	10 cm x 10 cm
Relative humidity	50%
Polarizing voltage and polarity	no reference values are recommended but the values used should be stated in the calibration certificate
Dose rate	no reference values are recommended but the dose rate used should always be stated in the calibration certificate. It should also be stated whether a recombination correction has or has not been applied and if so, the value should be stated

^a After a water phantom with a plastic window has been filled, its dimensions may slowly change with time. When using a horizontal beam, it may therefore be necessary to check the source-surface distance and the chamber depth every few hours.

^b The temperature of the air in a chamber cavity should be taken to be that of the phantom, which should be measured; this is not necessarily the same as the temperature of the surrounding air

^c In some countries the reference air temperature is 22°C.

4.3.3. Calibration at other qualities

Only standards laboratories having an accelerator can perform calibrations in high-energy photon and electron beams. The user will be given either a series of calibration factors $N_{D,w,Q}$ at various beam qualities or a calibration factor N_{D,w,Q_0} plus measured values for k_{Q,Q_0} . Details on the calibration procedures at PSDLs are outside the scope of this document.

It should be noted that no standards of absorbed dose to water are yet available for proton and heavy-ion beams. However, a calibration factor in terms of absorbed dose to water can be obtained in the user proton beam when the standards laboratory is prepared to perform calibration measurements (with water calorimetry for instance) in the proton therapy centre.

TABLE 4.VI. REFERENCE CONDITIONS RECOMMENDED FOR THE CALIBRATION OF IONIZATION CHAMBERS IN LOW-ENERGY AND MEDIUM-ENERGY X-RAY BEAMS IN STANDARDS LABORATORIES

Influence quantity	Reference value or reference characteristic	
	low-energy x-rays	medium-energy x-rays
Phantom material	PMMA or water-equivalent plastic	water
Phantom size	12 cm x 12 cm x 6 cm	30 cm x 30 cm x 30 cm (approximately)
Source-surface distance (SSD)	treatment distance as specified by the user ^a	treatment distance as specified by the user ^a
Air temperature ^b	20 °C ^c	20 °C ^c
Air pressure	101.3 kPa	101.3 kPa
Reference point of the ionization chamber	for plane-parallel ionization chambers, the centre of the outside of the front window (or the outside of any additional build-up foil)	for cylindrical chambers, on the central axis at the centre of the cavity volume
Depth in phantom of the reference point of the chamber	surface	2 g cm ⁻²
Field size at the position of the reference point of the chamber ^d	3 cm x 3 cm or 3 cm diameter	10 cm x 10 cm
Relative humidity	50%	50%
Polarizing voltage and polarity	no reference values are recommended but the values used should be stated in the calibration certificate	
Dose rate	no reference values are recommended but the dose rate used should always be stated in the calibration certificate. It should also be stated whether a recombination correction has or has not been applied and if so, the value should be stated	

^a If more than one SSD is used, the greatest should be chosen for calibration.

^b The temperature of the air in a chamber cavity should be taken to be that of the phantom, which should be measured; this is not necessarily the same as the temperature of the surrounding air

^c In some countries the reference air temperature is 22°C.

^d If these field sizes do not correspond to any of the user beams, then the closest field size to this that will be used clinically should be used.

4.4. Reference dosimetry in the user beam

4.4.1. Determination of the absorbed dose to water

It is assumed that the user has an ionization chamber or a dosimeter with a calibration factor N_{D,w,Q_o} in terms of absorbed dose to water at a reference quality Q_o . Following the formalism given in Section 3, the chamber is positioned according to the reference conditions and the absorbed dose to water is given by

$$D_{w,Q} = M_Q N_{D,w,Q_o} k_{Q,Q_o} \quad (4.2)$$

where M_Q is the reading of the dosimeter incorporating the product $\prod k_i$ of correction factors for influence quantities, and k_{Q,Q_o} is the correction factor which corrects for the difference between the reference beam quality Q_o and the actual quality Q being used. This equation is valid for all the radiation fields for which the present Code of Practice applies.

Details on the reference conditions to be used for radiotherapy beam calibrations and values for the factor k_{Q,Q_0} will be given in the individual Sections dealing with the various radiation types. Recommendations on relative dosimetry, namely the determination of distributions of absorbed dose, will also be given in the respective Sections. Although the correction factor k_{Q,Q_0} is not different in kind from all other correction factors for influence quantities, because of its dominant role it is treated separately in each Section.

4.4.2. Practical considerations for measurements in the user beam

Precautions with regard to the waterproof sleeve of a chamber when carrying out measurements in a water phantom have been given in Section 4.2.4.

Before measurements are made, the stability of the dosimeter system should be verified using a check source. Enough time should be allowed for the dosimeter to reach thermal equilibrium. Some mains-powered electrometers are best switched on for at least 2 hours before use to allow stabilization. It is always advisable to pre-irradiate an ionization chamber with 2 Gy to 5 Gy to achieve charge equilibrium in the different materials. It is especially important to operate the measuring system under stable conditions whenever the polarity or polarizing voltage are modified which, depending on the chamber and sometimes on the polarity, might require several (up to 20) minutes. Indeed, failure to do so may result in errors which are larger than the effect for which one is correcting.

The leakage current is that generated by the complete measuring system in the absence of radiation. Leakage can also be radiation induced and chambers may show no leakage prior to irradiation yet have a significant leakage after irradiation. The leakage current should always be measured before and after irradiation, and should be small compared with the current obtained during the irradiation (less than approximately 0.1% of the measurement current and normally of the same sign). In some instances, for example small volume chambers used at low dose rates, the relative leakage current may be larger. If this is the case, the measurement current should be corrected for leakage, paying attention to the sign of the leakage current. Chambers with a leakage current which is large (approximately larger than 1% of the measurement current) or variable in time should not be used.

When relative measurements are carried out in accelerator and in kilovoltage x-ray beams it is strongly recommended that an additional monitoring dosimetry system be used during the experimental procedure to account for fluctuations in the radiation output. This is especially important when ratios of dosimeter readings are used (cross calibrations, measurements with different polarities or varying voltages, etc.). The external monitor should preferably be positioned within the phantom, along the major axis of the transverse plane, at the same depth as the chamber and at a distance of 3 cm or 4 cm from the central axis approximately; if the monitor is positioned in air the possible temperature drifts should be taken into account.

4.4.3. Correction for influence quantities

The calibration factor for an ionization chamber is valid only for the reference conditions which apply to the calibration. Any departure from the reference conditions when using the ionization chamber in the user beam should be corrected for using appropriate factors. In the following only general correction factors k_i are discussed, leaving items specific to each type of radiation beam to the relevant Section.

4.4.3.1. Pressure, temperature and humidity

As all chambers recommended in this document are open to the ambient air, the mass of air in the cavity volume is subject to atmospheric variations. The correction factor

$$k_{TP} = \frac{(273.2 + T) P_o}{(273.2 + T_o) P} \quad (4.3)$$

should be applied to convert the cavity air mass to the reference conditions. P and T are the cavity air pressure and temperature at the time of the measurements, and P_o and T_o are the reference values (generally 101.3 kPa and 20° C)¹⁵. The temperature of the air in a chamber cavity should be taken to be that of the phantom, which should be measured; this is not necessarily the same as the temperature of the surrounding air¹⁶. For measurements in a water phantom, the chamber waterproof sleeve should be vented to the atmosphere in order to obtain rapid equilibrium between the ambient air and the air in the chamber cavity.

No corrections for humidity are needed if the calibration factor was referred to a relative humidity of 50% and is used in a relative humidity between 20% and 80%. If the calibration factor is referred to dry air a correction factor should be applied [68]; for ⁶⁰Co calibrations $k_h = 0.997$.

4.4.3.2. Electrometer calibration

When the ionization chamber and the electrometer are calibrated separately, a calibration factor for each is given by the calibration laboratory. In the present Code of Practice, the electrometer calibration factor k_{elec} is treated as an influence quantity and is included in the product $\prod k_i$ of correction factors. Typically, the calibration factor $N_{D,w}$ for the ionization chamber will be given in units of Gy/nC and that for the electrometer k_{elec} either in units of nC/rdg or, if the electrometer readout is in terms of charge, as a dimensionless factor close to unity (effectively a calibration in units of nC/nC).

If the ionization chamber and the electrometer are calibrated together, then the combined calibration factor $N_{D,w}$ will typically be given in units of Gy/rdg or Gy/nC (depending on the electrometer readout) and no separate electrometer calibration factor k_{elec} is required. In this case, a value for k_{elec} of unity (dimensionless) should be recorded in the Worksheets.

4.4.3.3. Polarity effect

The effect on a chamber reading of using polarizing potentials of opposite polarity must always be checked on commissioning. For most chamber types the effect will be negligible in photon beams, a notable exception being the very thin window chambers used for low-energy x-rays. In charged particle beams, particularly electrons¹⁷, the effect may be significant.

When a chamber is used in a beam that produces a measurable polarity effect, the true reading is taken to be the mean of the absolute values of readings taken at both polarities. For the routine use of a given ionization chamber, a single polarizing potential and polarity is normally adopted. However, the effect on the chamber reading of using polarizing potentials of opposite polarity for each user beam quality Q can be accounted for by using a correction factor:

$$k_{pol} = \frac{|M_+| + |M_-|}{2M} \quad (4.4)$$

¹⁵ In some countries the reference temperature is 22°C.

¹⁶ The equilibrium temperature of a water phantom that has been filled for some hours will usually be a degree or so lower than room temperature because of evaporation from the water surface.

¹⁷ For plane-parallel chambers the polarity effect is generally more pronounced in low-energy electron beams [21]. However, for certain chamber types it has been shown that the polarity effect increases with energy [69]. For this reason the polarity effect should always be investigated at all electron energies.

where M_+ and M_- are the electrometer readings obtained at positive and negative polarity, respectively, and M is the electrometer reading obtained with the polarity used routinely (positive or negative). The readings M_+ and M_- should be made with care, ensuring that the chamber reading is stable following any change in polarity (some chambers can take up to 20 minutes to stabilize). To minimize the influence of fluctuations in the output of radiation generators (clinical accelerators, x-ray therapy units, etc), it is preferable that all the readings be normalized to that of an external monitor. Ideally, the external monitor should be positioned approximately at the depth of measurement but at a distance of 3 to 4 cm from the chamber centre along the major axis in the transverse plane of the beam.

When the chamber is sent for calibration, a decision is normally made, either by the user or by the calibration laboratory, on the polarizing potential and polarity to be adopted for the routine use of the chamber. The calibration should be carried out at this polarizing potential (and polarity, if only one polarity is used for the calibration), or if not, clearly stated. The calibration laboratory may or may not correct for the polarity effect at the calibration quality Q_0 . This should be stated in the calibration certificate.

When the calibration laboratory has already corrected for the polarity effect, then the user must apply the correction factor k_{pol} derived using Eq. (4.4) to all measurements made using the routine polarity. When the calibration laboratory has *not* corrected for the polarity effect, the subsequent treatment of the polarity effect depends on the facilities available to the user, and on what beam qualities must be measured:

- (a) If the user beam quality is the same as the calibration quality and the chamber is used at the *same polarizing potential and polarity*, then k_{pol} will be the same in both cases and the user must *not* apply a polarity correction for that particular beam (or equivalently k_{pol} is set equal to 1 in the worksheet). If it is not possible to use the same polarizing potential then the polarity effect will not be exactly the same in both cases. The difference should be small and should be estimated and included as an uncertainty.
- (b) If the user beam quality is *not* the same as the calibration quality, but it is possible to reproduce the calibration quality, then the polarity correction $[k_{pol}]_{Q_0}$ that was not applied at the time of calibration must be estimated using Eq. (4.4) and using the *same polarizing potential and polarity* as was used at the calibration laboratory. The polarity effect at the user beam quality, k_{pol} , must also be determined from Eq. (4.4.) using the polarizing potential and polarity adopted for routine use. A modified polarity correction is then evaluated as follows:

$$k_{pol} = \frac{k_{pol}}{[k_{pol}]_{Q_0}} \quad (4.5)$$

This is then used to correct the dosimeter readings for polarity for each beam quality Q .

Note that if the user beam quality is not the same as the calibration quality and it is *not* possible to reproduce the calibration quality to estimate the correction $[k_{pol}]_{Q_0}$, then this must be estimated from a knowledge of the chamber response to different beam qualities and polarities. If this can not be done with a relative standard uncertainty (see Appendix D.3) of less than 0.5% then either the chamber should not be used, or it should be sent to a calibration laboratory that can perform the required polarity correction.

4.4.3.4. Ion Recombination

The incomplete collection of charge in an ionization chamber cavity due to the recombination of ions requires the use of a correction factor k_s . Two separate effects take place; (i) the recombination of ions

formed by separate ionizing particle tracks, termed general (or volume) recombination, which is dependent on the density of ionizing particles and therefore on the dose rate, and (ii) the recombination of ions formed by a single ionizing particle track, referred to as initial recombination, which is independent of the dose rate. Both effects depend on the chamber geometry and on the applied polarizing voltage. For beams other than heavy ions, initial recombination is generally less than 0.2%.

In pulsed radiation, and especially in pulsed-scanned beams, the dose rate during a pulse is relatively high and general recombination is often significant. It is possible to derive a correction factor using the theory of Boag [70], but this does not account for chamber-to-chamber variations within a given chamber type. In addition, a slight movement of the central electrode in cylindrical chambers¹⁸ might invalidate the application of Boag's theory.

For pulsed beams, it is recommended in this Code of Practice that the correction factor k_s be derived using the two-voltage method [72], as was the recommendation in TRS-277 [17]. This method assumes a linear dependence of $1/M$ on $1/V$ and uses the measured values of the collected charges M_1 and M_2 at the polarizing voltages V_1 and V_2 , respectively, measured using the same irradiation conditions. V_1 is the normal operating voltage¹⁹ and V_2 a lower voltage; the ratio V_1/V_2 should ideally be equal to or larger than 3. Strictly, the polarity effect will change with the voltage and M_1 and M_2 should each be corrected for this effect using Eq. (4.4). The recombination correction factor k_s at the normal operating voltage V_1 is obtained from

$$k_s = a_o + a_1 \left(\frac{M_1}{M_2} \right) + a_2 \left(\frac{M_1}{M_2} \right)^2 \quad (4.6)$$

where the constants a_i are given in Table 4.VII for pulsed and for pulsed-scanned radiation. To minimize the influence of fluctuations in the output of clinical accelerators, all the readings should preferably be normalized to that of an external monitor. The external monitor should preferably be positioned inside the phantom approximately at the depth of measurement but at a distance of 3 to 4 cm away from the chamber centre along the major axis in the transverse plane of the beam.

For $k_s < 1.03$, the correction can be approximated to within 0.1% using the relation

$$k_s - 1 = \frac{M_1/M_2 - 1}{V_1/V_2 - 1} \quad (4.7)$$

i.e. the percentage correction is the percentage change in reading divided by a number which is one less than the voltage ratio [49]. This has the advantage of working for non-integral values of V_1/V_2 and also serves as a check on the evaluation using Eq. (4.6). Note that the correction factor k_s evaluated using the two-voltage method in pulsed beams corrects for both general and initial recombination [73].

A word of caution is required regarding the use of the two-voltage method for plane-parallel ionization chambers in pulsed beams. It has been shown [72-75] that for some plane-parallel chambers the expected linear dependence of $1/M$ on $1/V$ is not satisfied in the voltage interval used for the two-voltage method (see TRS-381 [21]). This effect can be compensated for by using the same two polarizing voltages for the dose determination in the user beam as are used for the chamber calibration at the standards laboratory or by the user in the case of a cross-calibration. Alternatively, the range of linearity of a chamber may be established in a pulsed beam by measuring the chamber response over a

¹⁸ This may be observed with a radiograph of the chamber. A radiograph should be done at the time of commissioning and when performing quality controls of dosimetry equipment [71].

¹⁹ It should be noted that the maximum allowed polarizing voltage is limited by the chamber design and the manufacturer's recommendations should be followed.

range of polarizing voltages up to the manufacturer's recommended maximum. This is a useful check on the performance of a chamber which should always be performed when commissioning a new chamber. If possible, the chamber should be used subsequently only at voltages within the linear range, in which case the use of the two-voltage method is valid.

In continuous radiation, notably ^{60}Co gamma rays, the two-voltage method may also be used and a correction factor derived using the relation ²⁰

$$k_s = \frac{(V_1/V_2)^2 - 1}{(V_1/V_2)^2 - (M_1/M_2)} \quad (4.8)$$

It is not recommended that the ion recombination effect in a plane parallel chamber used for low-energy x-rays be measured by changing the polarization voltage. The recombination is normally negligible, and changing the polarizing voltage usually distorts the window to give a change in response that exceeds any recombination effect.

TABLE 4.VII. QUADRATIC FIT COEFFICIENTS, FOR THE CALCULATION OF k_s BY THE "TWO-VOLTAGE" TECHNIQUE IN PULSED AND PULSED-SCANNED RADIATION, AS A FUNCTION OF THE VOLTAGE RATIO V_1/V_2 [76]

V_1/V_2	Pulsed			Pulsed scanned		
	a_0	a_1	a_2	a_0	a_1	a_2
2.0	2.337	-3.636	2.299	4.711	-8.242	4.533
2.5	1.474	-1.587	1.114	2.719	-3.977	2.261
3.0	1.198	-0.875	0.677	2.001	-2.402	1.404
3.5	1.080	-0.542	0.463	1.665	-1.647	0.984
4.0	1.022	-0.363	0.341	1.468	-1.200	0.734
5.0	0.975	-0.188	0.214	1.279	-0.750	0.474

Note that for the purpose of making recombination corrections, proton synchrotron beams of long pulse duration and low pulse repetition frequency may be considered as continuous.

For relative measurements, for example the determination of depth-dose distributions and the measurement of output factors, the recombination correction should be determined in a sufficient subset of conditions that appropriate corrections can be derived. In pulsed beams, where general recombination is dominant, the recombination correction for a given chamber will scale approximately linearly with dose rate. In continuous beams the recombination correction is small and approximately constant.

Recombination in heavy charged particle beams is more complex and is dealt with separately in Section 11. In scanned beams and other special beams of very high intensity, space charge effects cannot be neglected and the charge collection efficiency should be assessed by calibration against a dose rate independent system such as a calorimeter.

Note that the reference conditions for the calibration of ionization chambers in standards laboratories (see Tables 4.V and 4.VI) recommend that the calibration certificate states whether a recombination correction has or has not been applied. The preceding discussion and the worksheet in each section of this Code of Practice is based on the assumption that the calibration laboratory has applied a recombination correction, and therefore the procedure given for the determination of k_s refers only to recombination in the user beam. If the calibration laboratory has not applied a recombination

²⁰ This relation is based on a linear dependence of $1/M$ on $1/V^2$ which describes the effect of general recombination in continuous beams. The presence of initial recombination disturbs this linearity and a modified version of Eq. (4.8) should be used, but this is normally a small effect which may be neglected.

correction, the correction factor determined for the user beam quality Q must be divided by that appropriate to the calibration quality Q_0 , i.e.

$$k_s = \frac{k_{s,Q}}{k_{s,Q_0}} \quad (4.9)$$

When Q_0 is a continuous beam, k_{s,Q_0} will normally be close to unity and the effect of not applying k_{s,Q_0} either at calibration or using Eq. (4.9) will be negligible in most cases. However, when Q_0 is a pulsed beam, failure by the standards laboratory to apply k_{s,Q_0} at the time of calibration is a potential source of error, especially in the case where the dose per pulse in the user beam is very different from that used at calibration. If this is the case the user must determine k_{s,Q_0} in the clinic at a dose per pulse similar to that used at calibration (this may not be the dose per pulse normally used in the clinic). This determination does not need to be carried out at Q_0 ; it is the matching of the calibration dose per pulse which is important. To avoid a recurrence of this problem, the user should request that a recombination correction be applied, or at least measured, at the next calibration at a standards laboratory, especially for calibration in pulsed beams.

5. CODE OF PRACTICE FOR COBALT-60 GAMMA RAY BEAMS

5.1. General

This Section provides a Code of Practice for reference dosimetry (beam calibration) in the user's ^{60}Co gamma ray beam, and recommendations for relative dosimetry. It is based upon a calibration factor in terms of absorbed dose to water N_{D,w,Q_o} for a dosimeter in a reference beam of quality Q_o , where Q_o is ^{60}Co . In this situation $D_{w,Q}$ is denoted by D_w , k_{Q,Q_o} is denoted by k_Q which has a value of unity, and N_{D,w,Q_o} is denoted by $N_{D,w}$.

5.2. Dosimetry equipment

5.2.1. Ionization chambers

The recommendations regarding ionization chambers given in Section 4.2.1 should be followed. Both cylindrical and plane-parallel²¹ ionization chambers are recommended as reference instruments for the calibration of ^{60}Co gamma ray beams. The reference point of a cylindrical chamber for the purpose of calibration at the standards laboratory and for measurements under reference conditions in the user beam is taken to be on the chamber axis at the centre of the cavity volume. For plane-parallel chambers, it is taken to be on the inner surface of the entrance window, at the centre of the window. This point should be positioned at the reference depth in a water phantom. If a field instrument is used, this should be cross-calibrated against the calibrated reference chamber (see Section 5.5).

5.2.2. Phantoms and chamber sleeves

The recommendations regarding phantoms and chamber sleeves given in Sections 4.2.3 and 4.2.4 should be followed. Water is recommended as the reference medium for measurements of absorbed dose with ^{60}Co beams²². The phantom should extend to at least 5 cm beyond all four sides of the field size employed at the depth of measurement and also extend to at least 5 g cm⁻² beyond the maximum depth of measurement.

In horizontal beams, the window of the phantom should be made of plastic and of thickness t_{win} between 0.2 cm and 0.5 cm. The water-equivalent thickness (in g cm⁻²) of the phantom window should be taken into account when evaluating the depth at which the chamber is to be positioned; the thickness is calculated as the product $t_{win} \rho_{pl}$ where ρ_{pl} is the mass density of the plastic (in g cm⁻³). For commonly used plastics PMMA and clear polystyrene, the nominal values $\rho_{PMMA} = 1.19 \text{ g cm}^{-3}$ and $\rho_{polystyrene} = 1.06 \text{ g cm}^{-3}$ [66] may be used for the calculation of the water-equivalent thickness of the window.

For non-waterproof chambers a waterproofing sleeve should be used, made of PMMA and preferably not thicker than 1.0 mm. The air gap between the chamber wall and the waterproofing sleeve should be sufficient (0.1 mm to 0.3 mm) to allow the air pressure in the chamber to equilibrate. The same waterproofing sleeve that was used for calibration of the user's ionization chamber should also be used for reference dosimetry. If it is not possible to use the same waterproofing sleeve that was used during calibration at the standardizing laboratory, then another sleeve of the same material and of similar thickness should be used. Plane-parallel chambers, if not inherently waterproof or supplied with a waterproof cover, must be used in a waterproof enclosure, preferably of PMMA or a material

²¹ Plane-parallel chambers can be used for measurements under reference conditions in the user's ^{60}Co gamma ray beam when they are calibrated at the same quality.

²² Plastic phantoms should not be used for reference dosimetry. However, they can be used for routine quality assurance measurements, provided a transfer factor between plastic and water has been established.

that closely matches the chamber walls; ideally, there should be no more than 1 mm of added material in front of and behind the cavity volume.

5.3. Beam quality specification

Gamma ray spectra from ^{60}Co therapy sources used at hospitals or SSDs have a substantial component of low-energy scattered photons, originated in the source itself or in the treatment head, but ionization chamber measurements are not expected to be influenced by ^{60}Co spectral differences by more than a few tenths of one percent [29]. For this reason ^{60}Co gamma rays for radiotherapy dosimetry do not require a beam quality specifier other than the radionuclide.

5.4. Determination of absorbed dose to water

5.4.1. Reference conditions

The reference conditions for the determination of absorbed dose to water in a ^{60}Co gamma-ray beam are given in Table 5.I.

TABLE 5.I. REFERENCE CONDITIONS FOR THE DETERMINATION OF ABSORBED DOSE TO WATER IN ^{60}Co GAMMA-RAY BEAMS

Influence quantity	Reference value or reference characteristics
Phantom material	water
Chamber type	cylindrical or plane-parallel
Measurement depth z_{ref}	5 g cm ⁻² (or 10 g cm ⁻²) ^a
Reference point of chamber	for cylindrical chambers, on the central axis at the centre of the cavity volume. For plane-parallel chambers, on the inner surface of the window at its centre
Position of reference point of chamber	for cylindrical and plane-parallel chambers, at the measurement depth z_{ref}
SSD or SCD	80 cm or 100 cm ^b
Field size	10 cm x 10 cm ^c

^a In an ESTRO-IAEA report on Monitor Unit calculations [77], the use of a single reference depth $z_{ref} = 10 \text{ g cm}^{-2}$ for all photon beam energies is recommended. The constancy with depth of $N_{D,w}$ reported by the BIPM [30] validates this option. However, some users may prefer using the same reference depth as that used for the calibration of ionization chambers in ^{60}Co beams, i.e. $z_{ref} = 5 \text{ g cm}^{-2}$. The two options are therefore allowed in this Code of Practice.

^b The reference SSD or SCD (for SAD set-up) should be that used for clinical treatments.

^c The field size is defined at the surface of the phantom for a SSD type set-up, whereas for a SAD type set-up it is defined at the plane of the detector, placed at the reference depth in the water phantom at the isocentre of the machine.

5.4.2. Determination of absorbed dose under reference conditions

The general formalism is given in Section 3. The absorbed dose to water at the reference depth z_{ref} in water, in the user ^{60}Co beam and in the absence of the chamber, is given by

$$D_w = M N_{D,w} \quad (5.1)$$

where M is the reading of the dosimeter with the reference point of the chamber positioned at z_{ref} in accordance with the reference conditions given in Table 5.I and corrected for the influence quantities temperature and pressure, electrometer calibration, polarity effect and ion recombination as described in the Worksheet (see also Section 4.4.3). For ^{60}Co units, the timer error can influence M significantly. A method for calculating the timer error is given in the Worksheet. $N_{D,w}$ is the calibration factor in terms of absorbed dose to water for the dosimeter at the reference quality ^{60}Co .

5.4.3. Absorbed dose at z_{max}

Section 5.4.2 provides a methodology for determining absorbed dose at z_{ref} . However, clinical dosimetry calculations are often referred to the depth of dose maximum, z_{max} . To determine the absorbed dose at z_{max} the user should, for a given beam, use the central axis percentage depth-dose (PDD) data for SSD set-ups and tissue-maximum ratios (TMR) for SAD set-ups.

5.5. Cross-calibration of field ionization chambers

As noted in Section 5.2.1, a field chamber (either cylindrical or plane-parallel) may be cross-calibrated against a calibrated reference chamber in a ^{60}Co beam at the user facility. The chambers are compared by alternately placing each chamber in a water phantom with its reference point at z_{ref} in accordance with the reference conditions given in Table 5.I. A side-by-side chamber intercomparison is a possible alternative configuration. The calibration factor in terms of absorbed dose to water for the field ionization chamber is given by

$$N_{D,w}^{field} = \frac{M_{ref}}{M_{field}} N_{D,w}^{ref} \quad (5.2)$$

where M_{ref} and M_{field} are the meter readings per unit time for the reference and field chambers, respectively, corrected for the influence quantities as described in Section 4.4.3 and $N_{D,w}^{ref}$ is the calibration factor in terms of absorbed dose to water for the reference chamber. The field chamber with the calibration factor $N_{D,w}^{field}$ may be used subsequently for the determination of absorbed dose to water in the user ^{60}Co beam using the procedure of Section 5.4.2 where $N_{D,w}$ is replaced by $N_{D,w}^{field}$.

5.6. Measurements under non-reference conditions

Clinical dosimetry requires the measurements of central-axis percentage depth dose (PDD) distributions, tissue-phantom ratios (TPR) or tissue-maximum ratios (TMR), isodose distributions, transverse beam profiles and output factors as a function of field size and shape for both reference and non-reference conditions. Such measurements should be made for all possible combinations of field size and SSD or SAD used for radiotherapy treatment.

5.6.1. Central-axis depth-dose distributions

All measurements should follow the recommendations given in Section 4.2 regarding choices for phantoms and dosimeters, although other types of detectors can also be used. For measurements of depth-ionization curves, plane-parallel ionization chambers are recommended. If a cylindrical ionization chamber is used instead, then the effective point of measurement of the chamber must be taken into account. This requires that the complete depth-ionization distribution be shifted towards the surface a distance equal to $0.6 r_{cyl}$ [17, 21] where r_{cyl} is the cavity radius of the cylindrical ionization chamber. To make accurate measurements in the build-up region, extrapolation chambers or well-guarded fixed separation plane-parallel chambers should be used. Care should be taken in the use of certain solid state detectors (some types of diodes and diamond detectors) to measure depth-dose distributions (see, for instance, Ref. [21]); only a solid state detector whose response has been regularly verified against a reference detector (ion chamber) should be selected for these measurements.

Since the stopping-power ratios and perturbation effects can be assumed to a reasonable accuracy to be independent of depth and field size [78], relative ionization distributions can be used as relative distributions of absorbed dose, at least for depths at and beyond the depth of dose maximum.

5.6.2. Output factors

The output factor may be determined as the ratio of corrected dosimeter readings measured under a given set of non-reference conditions to that measured under reference conditions. These measurements are typically done at the depth of maximum dose or at the reference depth [77] and corrected to the depth of maximum dose using percentage depth-dose data (or TMR). When output factors are measured in open as well as wedged beams, special attention should be given to the uniformity of the radiation fluence over the chamber cavity. This is especially important for field sizes less than 5 cm x 5 cm.

In wedged beams the radiation intensity varies strongly in the direction of the wedge. For output measurements in such beams the detector dimension in the wedge direction should be as small as possible. Small thimble chambers aligned with their axis perpendicular to the wedge direction are recommended. The coincidence of the central axes of the beam, the collimator and the wedge should be ensured prior to making the output measurements.

5.7. Estimated uncertainty in the determination of absorbed dose to water under reference conditions

When a reference dosimeter is used for the determination of absorbed dose to water in the user beam, the uncertainties in the different physical quantities or procedures that contribute to the dose determination can be divided into two steps. Step 1 considers uncertainties up to the calibration of the user reference dosimeter in terms of $N_{D,w}$ at the standards laboratory. Step 2 deals with the calibration of the user beam and includes the uncertainties associated with the measurements at the reference point in a water phantom. Combining the uncertainties in quadrature in the various steps yields the combined standard uncertainty for the determination of the absorbed dose to water at the reference point.

An estimate of the uncertainties in the calibration of a ^{60}Co beam is given in Table 5.II. When the calibration of the reference dosimeter is carried out in an SSDL, the combined standard uncertainty in D_w is estimated to be typically around 0.9%. This estimate may vary depending on the uncertainty quoted by the calibration laboratory. If a field dosimeter is used, the uncertainty in dose determination increases somewhat (by approximately 0.2%) because of the additional step needed to cross-calibrate the field dosimeter against the calibrated reference dosimeter.

TABLE 5.II. ESTIMATED RELATIVE STANDARD UNCERTAINTY ^a OF D_w AT THE REFERENCE DEPTH IN WATER FOR A ^{60}Co BEAM

Physical quantity or procedure	Relative standard uncertainty (%)
<i>Step 1: Standards Laboratory</i> ^b	
<i>Uncertainty (%)</i>	
$N_{D,w}$ calibration of secondary standard at PSDL	0.5
Long term stability of secondary standard	0.1
$N_{D,w}$ calibration of the user dosimeter at the standards lab	0.4
<i>Combined uncertainty of Step 1</i>	<i>0.6</i>
<i>Step 2: User ^{60}Co beam</i>	
Long-term stability of user dosimeter	0.3
Establishment of reference conditions	0.5
Dosimeter reading M_Q relative to timer or beam monitor	0.1
Correction for influence quantities k_i	0.3
<i>Combined uncertainty of Step 2</i>	<i>0.6</i>
Combined standard uncertainty of D_w (Steps 1 + 2)	0.9

^a See ISO Guide to the expression of uncertainty [32] or Appendix D. The estimates given in the table should be considered typical values; these may vary depending on the uncertainty quoted by standards laboratories for calibration factors and on the experimental uncertainty at the user institution.

^b If the calibration of the user dosimeter is performed at a PSDL then the combined standard uncertainty in Step 1 is lower. The combined standard uncertainty in D_w should be adjusted accordingly.

5.8. Worksheet

Determination of the absorbed dose to water in a ^{60}Co gamma-ray beam

User: _____ Date: _____

1. Radiation treatment unit and reference conditions for D_w determination

^{60}Co therapy unit: _____
 Reference phantom: water Set up: SSD SAD
 Reference field size: 10x10 cm x cm Reference distance: _____ cm
 Reference depth z_{ref} : _____ g cm⁻²

2. Ionization chamber and electrometer

Ionization chamber model: _____ Serial no.: _____ Type: cyl pp
 Chamber wall / window material: _____ thickness: _____ g cm⁻²
 Waterproof sleeve / cover material: _____ thickness: _____ g cm⁻²
 Phantom window material: _____ thickness: _____ g cm⁻²
Absorbed-dose-to-water calibration factor $N_{D,w} =$ _____ Gy nC⁻¹ Gy rdg⁻¹
 Reference conditions for calibration P_o : _____ kPa T_o : _____ °C Rel. humidity: _____ %
 Polarizing potential V_j : _____ V Calibration polarity: +ve -ve corrected for polarity effect
 User polarity: +ve -ve
 Calibration laboratory: _____ Date: _____
 Electrometer model: _____ Serial no.: _____
 Calibrated separately from chamber: yes no Range setting: _____
 If yes Calibration laboratory: _____ Date: _____

3. Dosimeter reading^a and correction for influence quantities

Uncorrected dosimeter reading at V_j and user polarity: _____ nC rdg
 Corresponding time: _____ min
 Ratio of dosimeter reading and time^b: $M_I =$ _____ nC min⁻¹ rdg min⁻¹
 (i) Pressure P : _____ kPa Temperature T : _____ °C Rel. humidity (if known): _____ %

$$k_{TP} = \frac{(273.2 + T) P_o}{(273.2 + T_o) P} =$$

 (ii) Electrometer calibration factor^c k_{elec} : nC rdg⁻¹ dimensionless $k_{elec} =$ _____
 (iii) Polarity correction^d rdg at $+V_j$: $M_+ =$ _____ rdg at $-V_j$: $M_- =$ _____

$$k_{pol} = \frac{|M_+| + |M_-|}{2M} =$$

(iv) Recombination correction (two-voltage method)

Polarizing voltages: V_1 (normal) = _____ V V_2 (reduced) = _____ V

Readings^e at each V: M_1 = _____ M_2 = _____

Voltage ratio V_1 / V_2 = _____ Ratio of readings M_1 / M_2 = _____

$$k_s = \frac{(V_1/V_2)^2 - 1}{(V_1/V_2)^2 - (M_1/M_2)} = \text{_____}^f$$

Corrected dosimeter reading at the voltage V_1 :

$$M = M_1 k_{TP} k_{elec} k_{pol} k_s = \text{_____} \square \text{ nC min}^{-1} \square \text{ rdg min}^{-1}$$

4. Absorbed dose rate to water at the reference depth, z_{ref}

$$D_w(z_{ref}) = M N_{D,w} = \text{_____} \text{ Gy min}^{-1}$$

5. Absorbed dose rate to water at the depth of dose maximum, z_{max}

Depth of dose maximum: $z_{max} = \underline{0.5}$ g cm⁻²

(i) SSD set-up

Percentage depth-dose at z_{ref} for a 10 cm x 10 cm field size: $PDD(z_{ref} = \text{_____ g cm}^{-2}) = \text{_____} \%$

Absorbed-dose rate calibration at z_{max} :

$$D_w(z_{max}) = 100 D_w(z_{ref}) / PDD(z_{ref}) = \text{_____} \text{ Gy min}^{-1}$$

(ii) SAD set-up

TMR at z_{ref} for a 10 cm x 10 cm field size: $TMR(z_{ref} = \text{_____ g cm}^{-2}) = \text{_____}$

Absorbed-dose rate calibration at z_{max} :

$$D_w(z_{max}) = D_w(z_{ref}) / TMR(z_{ref}) = \text{_____} \text{ Gy min}^{-1}$$

^a All readings should be checked for leakage and corrected if necessary

^b The timer error should be taken into account. The correction at voltage V_1 can be determined according to

M_A is the integrated reading in a time t_A $M_A = \text{_____}$ $t_A = \text{_____}$ min

M_B is the integrated reading in n short exposures of time t_B/n each ($2 \leq n \leq 5$) $M_B = \text{_____}$ $t_B = \text{_____}$ min $n = \text{_____}$

$$\text{Timer error, } \tau = \frac{M_B t_A - M_A t_B}{n M_A - M_B} = \text{_____} \text{ min (the sign of } \tau \text{ must be taken into account)}$$

$$M_1 = \frac{M_A}{t_A + \tau} = \text{_____} \square \text{ nC min}^{-1} \square \text{ rdg min}^{-1}$$

^c If the electrometer is not calibrated separately set $k_{elec} = 1$

^d M in the denominator of k_{pol} denotes reading at the user polarity. Preferably, each reading in the equation should be the average of the ratios of M (or M_+ or M_-) to the reading of an external monitor, M_{em} .

^e Strictly, readings should be corrected for polarity effect (average with both polarities). Preferably, each reading in the equation should be the average of the ratios of M_1 or M_2 to the reading of an external monitor, M_{em} .

^f It is assumed that the calibration laboratory has performed a recombination correction. Otherwise the factor $k'_s = k_s / k_{s,Q_o}$ should be used instead of k_s . When Q_o is ^{60}Co , k_{s,Q_o} (at the calibration laboratory) will normally be close to unity and the effect of not using this equation will be negligible in most cases.

6. CODE OF PRACTICE FOR HIGH-ENERGY PHOTON BEAMS

6.1. General

This Section provides a Code of Practice for reference dosimetry (beam calibration) in clinical high-energy photon beams, and recommendations for relative dosimetry. It is based upon a calibration factor in terms of absorbed dose to water N_{D,w,Q_o} for a dosimeter in a reference beam of quality Q_o . The Code of Practice applies to photon beams generated by electrons with energies in the range from 1 MeV to 50 MeV.

For photon beams, the most common reference beam quality Q_o is ^{60}Co gamma rays. Some PSDLs can provide calibration factors $N_{D,w,Q}$ at other photon beam qualities Q but ^{60}Co is the only quality available in most standards laboratories. For this reason all data given in this Section have ^{60}Co gamma rays as the reference quality. Users having access to other calibration qualities can still use the present Code of Practice by renormalizing the various $N_{D,w,Q}$ to the N_{D,w,Q_o} of ^{60}Co . The ratios of $N_{D,w,Q}$ to that of ^{60}Co provide an experimental determination of the k_Q factors (see Sections 4.1 and 6.5.2). Note that when the reference quality Q_o is ^{60}Co , k_{Q,Q_o} is denoted by k_Q and N_{D,w,Q_o} is denoted by $N_{D,w}$. If available, directly measured values of k_{Q,Q_o} or k_Q for an individual chamber are the preferred option; if they are not available, the calculated values of k_Q for the appropriate chamber type given in the present Code of Practice should be used.

6.2. Dosimetry equipment

6.2.1. Ionization chambers

The recommendations regarding ionization chambers given in Section 4.2.1 should be followed. Only cylindrical ionization chambers are recommended for reference dosimetry in high-energy photon beams. The chamber types for which data are given in the present Code of Practice are listed in Table 6.III. Plane-parallel chambers can only be used for relative dosimetry²³. For high-energy photon beams the reference point of a cylindrical chamber for the purpose of calibration at the standards laboratory and for measurements under reference conditions in the user beam is taken to be on the chamber axis at the centre of the cavity volume. For plane-parallel chambers, it is taken to be on the inner surface of the entrance window, at the centre of the window. This point should be positioned at the reference depth in a water phantom. If a field instrument is used, this should be cross-calibrated against a calibrated reference chamber at the reference quality Q_o (see Section 6.6).

6.2.2. Phantoms and chamber sleeves

The recommendations regarding phantoms and chamber sleeves given in Sections 4.2.3 and 4.2.4 should be followed. Water is recommended as the reference medium for measurements of absorbed dose and beam quality in photon beams²⁴. The phantom should extend to at least 5 cm beyond all four sides of the field size employed at the depth of measurement and also extend to at least 5 g cm⁻² beyond the maximum depth of measurement.

In horizontal beams, the window of the phantom should be made of plastic and of thickness t_{win} between 0.2 cm and 0.5 cm. The water-equivalent thickness (in g cm⁻²) of the phantom window should

²³ Only when a plane-parallel chamber has been calibrated in the same beam quality as the user beam can this chamber be used for measurements in reference conditions. When calculated k_Q values are used, the lack of data for the wall correction factor p_{wall} for plane-parallel chambers in high-energy photon beams (c.f. TRS-381 [21]) makes these chambers inappropriate.

²⁴ Plastic phantoms should not be used for reference dosimetry. However, they can be used for routine quality assurance measurements, provided a transfer factor between plastic and water has been established.

be taken into account when evaluating the depth at which the chamber is to be positioned; the thickness is calculated as the product $t_{win} \rho_{pl}$ where ρ_{pl} is the mass density of the plastic (in g cm^{-3}). For commonly used plastics PMMA and clear polystyrene, the nominal values $\rho_{PMMA} = 1.19 \text{ g cm}^{-3}$ and $\rho_{polystyrene} = 1.06 \text{ g cm}^{-3}$ [66] may be used for the calculation of the water-equivalent thickness of the window.

For non-waterproof chambers a waterproofing sleeve should be used, made of PMMA, and preferably not thicker than 1.0 mm. The air gap between the chamber wall and the waterproofing sleeve should be sufficient (0.1 mm to 0.3 mm) to allow the air pressure in the chamber to equilibrate. The same waterproofing sleeve that was used for calibration of the user's ionization chamber should also be used for reference dosimetry. If it is not possible to use the same waterproofing sleeve that was used during calibration at the standardizing laboratory, then another sleeve of the same material and of similar thickness should be used.

6.3. Beam quality specification

6.3.1. Choice of beam quality index

For high-energy photons produced by clinical accelerators the beam quality Q is specified by the tissue-phantom ratio, $TPR_{20,10}$. This is the ratio of the absorbed doses at depths of 20 cm and 10 cm in a water phantom, measured with a constant source-chamber distance of 100 cm and a field size of 10 cm x 10 cm at the plane of the chamber²⁵.

The most important characteristic of the beam quality index $TPR_{20,10}$ is its independence on the electron contamination in the incident beam. It is also a measure of the effective attenuation coefficient describing the approximately exponential decrease of a photon depth-dose curve beyond the depth of maximum dose [82-84]. As $TPR_{20,10}$ is obtained as a ratio of doses, it does not require the use of displacement correction factors at two depths when cylindrical chambers are used. Furthermore, $TPR_{20,10}$ is in most clinical set ups not affected by small systematic errors in positioning the chamber at each depth, as the settings in the two positions will be affected in a similar manner.

Other beam quality specifiers, such as the percentage depth dose at 10 cm depth and the depth of the 80% depth-dose have been proposed in the literature. An overview of photon beam quality specifiers is given in Appendix C (see also ref. [85]), based on a description provided by the ICRU [29]. It should be emphasized, however, that there is no beam quality index that satisfies all possible requirements of being a unique index for the entire energy range of this Code of Practice and all possible accelerators used in hospitals and standards laboratories. This is of importance because the beams produced by the non-clinical accelerators found in some standards laboratories will in general not be identical to those from clinical accelerators.

²⁵ $TPR_{20,10}$ can also be obtained from the simple relation [79]

$$TPR_{20,10} = 1.2661 PDD_{20,10} - 0.0595$$

where $PDD_{20,10}$ is the ratio of the percent depth-doses at 20 cm and 10 cm depths for a field size of 10 cm x 10 cm defined at the phantom surface with an SSD of 100 cm. This empirical equation was obtained from a sample of almost 700 accelerators and has confirmed an earlier fit [80] used in TRS-277 [17].

Alternatively, $TPR_{20,10}$ can be estimated from a fit to the data for the percentage depth-dose at 10 cm depth, $PDD(10)$, measured for a 10 cm x 10 cm field size at an SSD of 100 cm. For the data published in BJR-25 [81] one obtains:

$$TPR_{20,10} = -0.7898 + 0.0329 PDD(10) - 0.000166 PDD(10)^2$$

Except at the highest energy of 50 MV (corresponding to a $PDD(10)$ value of 91%), the maximum deviation of the data about the fit is about 0.6% and occurs at $PDD(10) = 75\%$. At $PDD(10) = 91\%$, the deviation of the data about the fit is about 1%. Because electron contamination at the depth of maximum absorbed dose might affect the percent depth-dose at 10 cm depth, the fit should only be used as an estimation of the relation between $TPR_{20,10}$ and $PDD(10)$, but not for beam calibration. Note that above 10 MV, the $PDD(10)$ in the fit does not coincide with the $PDD(10)_x$ used in AAPM TG-51 [51], which refers exclusively to "pure" photon beams, that is, without electron contamination.

6.3.2. Measurement of beam quality

The experimental set up for measuring $TPR_{20,10}$ is shown in Fig. 6.1. The reference conditions of measurements are given in Table 6.I.

Although the definition of $TPR_{20,10}$ is strictly made in terms of ratios of absorbed dose, the use of ionization ratios provides an acceptable accuracy due to the slow variation with depth of water/air stopping-power ratios and the assumed constancy of perturbation factors beyond the depth of dose maximum. The influence of recombination effects at the two depths should be investigated and taken into account if there is a variation with depth.

TABLE 6.I. REFERENCE CONDITIONS FOR THE DETERMINATION OF PHOTON BEAM QUALITY ($TPR_{20,10}$)

Influence quantity	Reference value or reference characteristics
Phantom material	water
Chamber type	cylindrical or plane-parallel
Measurement depths	20 g cm^{-2} and 10 g cm^{-2}
Reference point of chamber	for cylindrical chambers, on the central axis at the centre of the cavity volume. For plane-parallel chambers, on the inner surface of the window at its centre
Position of reference point of chamber	for cylindrical and plane-parallel chambers, at the measurement depths
SCD	100 cm
Field size at SCD	$10 \text{ cm} \times 10 \text{ cm}^a$

^a The field size is defined at the plane of the reference point of the detector, placed at the recommended depths in the water phantom.

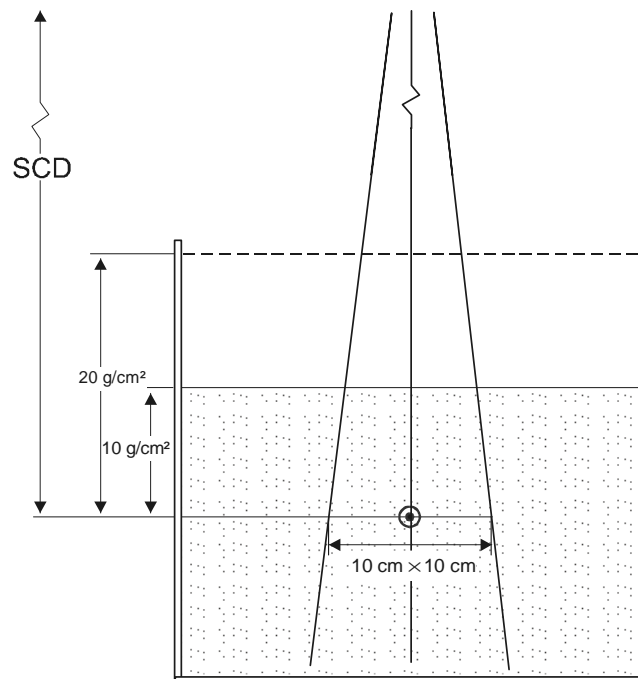

Fig. 6.1. Experimental set-up for the determination of the beam quality index Q ($TPR_{20,10}$). The source-to-chamber distance (SCD) is kept constant at 100 cm and measurements are made with 10 g cm^{-2} and 20 g cm^{-2} of water over the chamber. The field size at the position of the reference point of the chamber is $10 \text{ cm} \times 10 \text{ cm}$. Either a cylindrical or a plane-parallel ionization chamber can be used.

6.4. Determination of absorbed dose to water

6.4.1. Reference conditions

The reference conditions for determination of absorbed dose to water are given in Table 6.II.

TABLE 6.II. REFERENCE CONDITIONS FOR THE DETERMINATION OF ABSORBED DOSE TO WATER IN HIGH-ENERGY PHOTON BEAMS

Influence quantity	Reference value or reference characteristics
Phantom material	water
Chamber type	cylindrical
Measurement depth z_{ref}	for $TPR_{20,10} < 0.7$, 10 g cm^{-2} (or 5 g cm^{-2}) ^a for $TPR_{20,10} \geq 0.7$, 10 g cm^{-2}
Reference point of chamber	on the central axis at the centre of the cavity volume
Position of reference point of chamber	at the measurement depth z_{ref}
SSD/SCD	100 cm ^b
Field size	10 cm x 10 cm ^c

^a In an ESTRO-IAEA report on Monitor Unit calculations [77], the use of a single reference depth $z_{ref} = 10 \text{ g cm}^{-2}$ for all photon beam energies is recommended. The constancy with depth of $N_{D,w}$ reported by the BIPM [30] validates this option. However, some users may prefer using the same reference depth as that used for ^{60}Co beams, i.e. $z_{ref} = 5 \text{ g cm}^{-2}$; this option is therefore allowed in this Code of Practice.

^b If the reference dose has to be determined for an isocentric set up, the SAD of the accelerator shall be used even if this is not 100 cm.

^c The field size is defined at the surface of the phantom for a SSD type set-up, whereas for a SAD type set-up it is defined at the plane of the detector, placed at the reference depth in the water phantom at the isocentre of the machine.

6.4.2. Determination of absorbed dose under reference conditions

The general formalism is given in Section 3. The absorbed dose to water at the reference depth z_{ref} in water, in a photon beam of quality Q and in the absence of the chamber, is given by

$$D_{w,Q} = M_Q N_{D,w,Q_o} k_{Q,Q_o} \quad (6.1)$$

where M_Q is the reading of the dosimeter with the reference point of the chamber positioned at z_{ref} in accordance with the reference conditions given in Section 6.4.1 and corrected for the influence quantities temperature and pressure, electrometer calibration, polarity effect and ion recombination as described in the Worksheet (see also Section 4.4.3). N_{D,w,Q_o} is the calibration factor in terms of absorbed dose to water for the dosimeter at the reference quality Q_o , and k_{Q,Q_o} is a chamber-specific factor which corrects for the difference between the reference beam quality Q_o and the actual quality being used, Q .

6.4.3. Absorbed dose at z_{max}

Section 6.4.2 provides a methodology for determining absorbed dose at z_{ref} . However, clinical dosimetry calculations are often referenced to the depth of dose maximum z_{max} (or at some other depth). To determine the absorbed dose at the appropriate depth the user should, for a given beam, use the central axis percentage depth-dose (PDD) data for SSD set-ups and tissue-phantom ratios (TPR) or tissue-maximum ratios (TMR) for SAD set-ups. Section 6.7.1 describes how to generate central axis percent depth-dose data.

6.5. Values for k_{Q,Q_0}

6.5.1. Chamber calibrated in ^{60}Co

When the reference quality Q_0 is ^{60}Co , k_{Q,Q_0} is denoted by k_Q and N_{D,w,Q_0} is denoted by $N_{D,w}$.

Calculated values for the factor k_Q are given in Table 6.III for a series of user qualities Q (i.e., $TPR_{20,10}$) and for a number of chamber types. These values have been adapted from the calculations of Andreo [20] and can be used at the reference depths given in Table 6.II. A sleeve of PMMA 0.5 mm thick has been used in the calculations for all the chambers which are not waterproof; for sleeve thicknesses up to 1 mm the change in k_Q is not greater than about 0.1%. Values of k_Q for non-tabulated qualities may be obtained by interpolation. For illustrative purposes a plot of calculated k_Q values for selected chamber types in common use is given in Fig.6.2. The stopping-power ratios and perturbation factors used to calculate k_Q are described in Appendix B. It is emphasized that calculated k_Q values cannot distinguish chamber-to-chamber variations within a given chamber type and their use necessarily involves larger uncertainties than directly measured values (see Section 6.8).

It should be noted that there is no value of Q that corresponds to ^{60}Co where all the k_Q values are equal to 1.000. While in principle there is a value of $TPR_{20,10}$ that would correspond to a pure ^{60}Co spectrum, the response of a particular chamber in an accelerator beam of the same $TPR_{20,10}$ depends on its energy response over the whole spectrum, and will not necessarily be the same as for ^{60}Co . In addition there is considerable disagreement in the literature as to what the $TPR_{20,10}$ of a ^{60}Co beam is (0.568 for the beam at the NPL [86]; 0.572 in BJR 17 [87], BJR 25 [81] and at ARPANSA [88]; 0.578 at NRC [89]; 0.579 in Johns and Cunningham's textbook [90], etc.), so that a single reference value cannot be used.

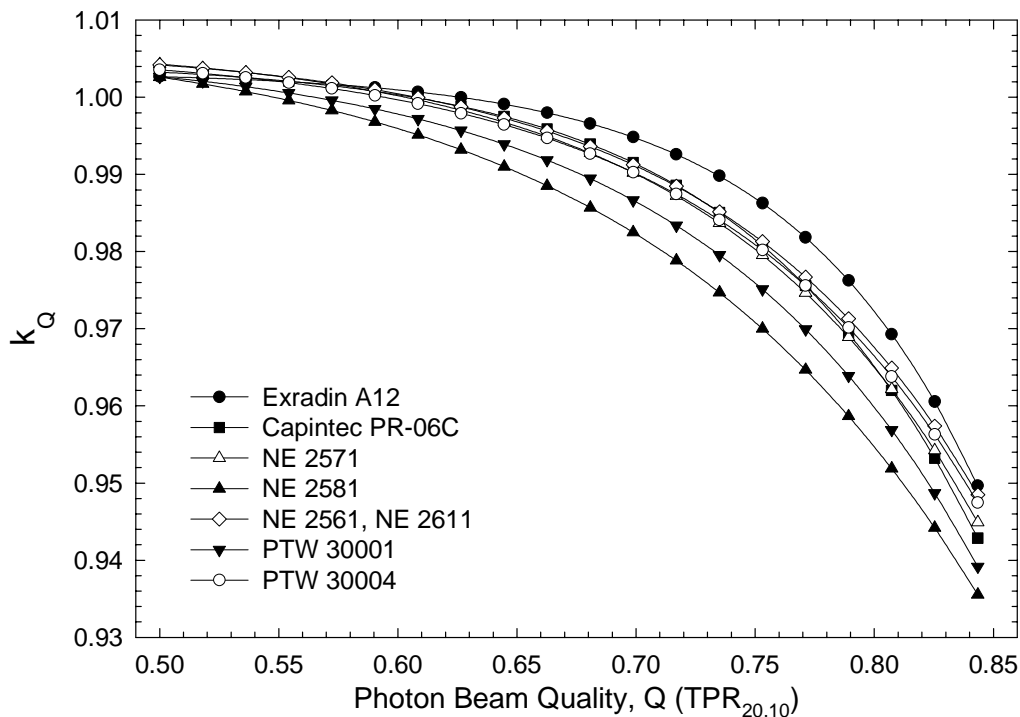

Fig. 6.2. Sigmoidal fits of calculated values of k_Q for various cylindrical ionization chambers commonly used for reference dosimetry, as a function of photon beam quality Q ($TPR_{20,10}$). Open symbols correspond to graphite-walled ionization chambers, solid symbols to plastic-walled chambers. Data from Table 6.III.

TABLE 6.III. CALCULATED VALUES OF k_Q FOR HIGH-ENERGY PHOTON BEAMS, FOR VARIOUS CYLINDRICAL IONIZATION CHAMBERS AS A FUNCTION OF BEAM QUALITY $TPR_{20,10}$
(Adapted from Andreo [20])

Ionization chamber type ^a	Beam quality $TPR_{20,10}$														
	0.50	0.53	0.56	0.59	0.62	0.65	0.68	0.70	0.72	0.74	0.76	0.78	0.80	0.82	0.84
Capintec PR-05P mini	1.004	1.003	1.002	1.001	1.000	0.998	0.996	0.994	0.991	0.987	0.983	0.975	0.968	0.960	0.949
Capintec PR-05 mini	1.004	1.003	1.002	1.001	1.000	0.998	0.996	0.994	0.991	0.987	0.983	0.975	0.968	0.960	0.949
Capintec PR-06C/G Farmer	1.001	1.001	1.000	0.998	0.998	0.995	0.992	0.990	0.988	0.984	0.980	0.972	0.965	0.956	0.944
Exradin A2 Spokas	1.001	1.001	1.001	1.000	0.999	0.997	0.996	0.994	0.992	0.989	0.986	0.979	0.971	0.962	0.949
Exradin T2 Spokas	1.002	1.001	0.999	0.996	0.993	0.988	0.984	0.980	0.977	0.973	0.969	0.962	0.954	0.946	0.934
Exradin A1 mini Shonka	1.002	1.002	1.001	1.000	1.000	0.998	0.996	0.994	0.991	0.986	0.982	0.974	0.966	0.957	0.945
Exradin T1 mini Shonka	1.003	1.001	0.999	0.996	0.993	0.988	0.984	0.980	0.975	0.970	0.965	0.957	0.949	0.942	0.930
Exradin A12 Farmer	1.001	1.001	1.000	1.000	0.999	0.997	0.994	0.992	0.990	0.986	0.981	0.974	0.966	0.957	0.944
Far West Tech IC-18	1.005	1.003	1.000	0.997	0.993	0.988	0.983	0.979	0.976	0.971	0.966	0.959	0.953	0.945	0.934
FZH TK 01	1.002	1.001	1.000	0.998	0.996	0.993	0.990	0.987	0.984	0.980	0.975	0.968	0.960	0.952	0.939
Nuclear Assoc 30-750	1.001	1.001	1.000	0.999	0.998	0.996	0.994	0.991	0.988	0.984	0.979	0.971	0.963	0.954	0.941
Nuclear Assoc 30-749	1.001	1.000	1.000	0.999	0.998	0.996	0.994	0.992	0.989	0.984	0.980	0.972	0.964	0.956	0.942
Nuclear Assoc 30-744	1.001	1.000	1.000	0.999	0.998	0.996	0.994	0.992	0.989	0.984	0.980	0.972	0.964	0.956	0.942
Nuclear Assoc 30-716	1.001	1.000	1.000	0.999	0.998	0.996	0.994	0.992	0.989	0.984	0.980	0.972	0.964	0.956	0.942
Nuclear Assoc 30-753 Farmer shortened	1.001	1.000	1.000	0.999	0.998	0.996	0.994	0.992	0.989	0.985	0.980	0.973	0.965	0.956	0.943
Nuclear Assoc 30-751 Farmer	1.002	1.002	1.000	0.999	0.997	0.994	0.991	0.989	0.985	0.981	0.977	0.969	0.961	0.953	0.940
Nuclear Assoc 30-752 Farmer	1.004	1.003	1.001	1.000	0.998	0.996	0.993	0.991	0.989	0.985	0.981	0.974	0.967	0.959	0.947
NE 2515	1.001	1.001	1.000	0.999	0.997	0.994	0.991	0.988	0.984	0.980	0.975	0.967	0.959	0.950	0.937
NE 2515/3	1.005	1.004	1.002	1.000	0.998	0.995	0.993	0.991	0.989	0.986	0.982	0.975	0.969	0.961	0.949
NE 2577	1.005	1.004	1.002	1.000	0.998	0.995	0.993	0.991	0.989	0.986	0.982	0.975	0.969	0.961	0.949
NE 2505 Farmer	1.001	1.001	1.000	0.999	0.997	0.994	0.991	0.988	0.984	0.980	0.975	0.967	0.959	0.950	0.937
NE 2505/A Farmer	1.005	1.003	1.001	0.997	0.995	0.990	0.985	0.982	0.978	0.974	0.969	0.962	0.955	0.947	0.936
NE 2505/3, 3A Farmer	1.005	1.004	1.002	1.000	0.998	0.995	0.993	0.991	0.989	0.986	0.982	0.975	0.969	0.961	0.949
NE 2505/3, 3B Farmer	1.006	1.004	1.001	0.999	0.996	0.991	0.987	0.984	0.980	0.976	0.971	0.964	0.957	0.950	0.938
NE 2571 Farmer	1.005	1.004	1.002	1.000	0.998	0.995	0.993	0.991	0.989	0.986	0.982	0.975	0.969	0.961	0.949
NE 2581 Farmer	1.005	1.003	1.001	0.998	0.995	0.991	0.986	0.983	0.980	0.975	0.970	0.963	0.956	0.949	0.937
NE 2561 / 2611 Sec Std	1.006	1.004	1.001	0.999	0.998	0.994	0.992	0.990	0.988	0.985	0.982	0.975	0.969	0.961	0.949

Ionization chamber type ^a	Beam quality <i>TPR</i> _{20,10}														
	0.50	0.53	0.56	0.59	0.62	0.65	0.68	0.70	0.72	0.74	0.76	0.78	0.80	0.82	0.84
PTW 23323 micro	1.003	1.003	1.000	0.999	0.997	0.993	0.990	0.987	0.984	0.980	0.975	0.967	0.960	0.953	0.941
PTW 23331 rigid	1.004	1.003	1.000	0.999	0.997	0.993	0.990	0.988	0.985	0.982	0.978	0.971	0.964	0.956	0.945
PTW 23332 rigid	1.004	1.003	1.001	0.999	0.997	0.994	0.990	0.988	0.984	0.980	0.976	0.968	0.961	0.954	0.943
PTW 23333	1.004	1.003	1.001	0.999	0.997	0.994	0.990	0.988	0.985	0.981	0.976	0.969	0.963	0.955	0.943
PTW 30001/30010 Farmer	1.004	1.003	1.001	0.999	0.997	0.994	0.990	0.988	0.985	0.981	0.976	0.969	0.962	0.955	0.943
PTW 30002/30011 Farmer	1.006	1.004	1.001	0.999	0.997	0.994	0.992	0.990	0.987	0.984	0.980	0.973	0.967	0.959	0.948
PTW 30004/30012 Farmer	1.006	1.005	1.002	1.000	0.999	0.996	0.994	0.992	0.989	0.986	0.982	0.976	0.969	0.962	0.950
PTW 30006/30013 Farmer	1.002	1.002	1.000	0.999	0.997	0.994	0.990	0.988	0.984	0.980	0.975	0.968	0.960	0.952	0.940
PTW 31002 flexible	1.003	1.002	1.000	0.999	0.997	0.994	0.990	0.988	0.984	0.980	0.975	0.968	0.960	0.952	0.940
PTW 31003 flexible	1.003	1.002	1.000	0.999	0.997	0.994	0.990	0.988	0.984	0.980	0.975	0.968	0.960	0.952	0.940
SNC 100730 Farmer	1.004	1.003	1.001	0.999	0.997	0.993	0.990	0.988	0.985	0.981	0.977	0.970	0.963	0.956	0.944
SNC 100740 Farmer	1.006	1.005	1.002	1.000	0.999	0.996	0.994	0.992	0.990	0.987	0.983	0.977	0.971	0.963	0.951
Victoreen Radocon III 550	1.005	1.004	1.001	0.998	0.996	0.993	0.989	0.986	0.983	0.979	0.975	0.968	0.961	0.954	0.943
Victoreen Radocon II 555	1.005	1.003	1.000	0.997	0.995	0.990	0.986	0.983	0.979	0.975	0.970	0.963	0.956	0.949	0.938
Victoreen 30-348	1.004	1.003	1.000	0.998	0.996	0.992	0.989	0.986	0.982	0.978	0.973	0.966	0.959	0.951	0.940
Victoreen 30-351	1.004	1.002	1.000	0.998	0.996	0.992	0.989	0.986	0.983	0.979	0.974	0.967	0.960	0.952	0.941
Victoreen 30-349	1.003	1.002	1.000	0.998	0.996	0.992	0.989	0.986	0.983	0.980	0.976	0.969	0.962	0.954	0.942
Victoreen 30-361	1.004	1.003	1.000	0.998	0.996	0.992	0.989	0.986	0.983	0.979	0.974	0.967	0.960	0.953	0.942
Wellhöfer IC 05	1.001	1.000	1.000	0.999	0.998	0.996	0.994	0.992	0.989	0.984	0.980	0.972	0.964	0.956	0.942
Wellhöfer IC 06	1.001	1.000	1.000	0.999	0.998	0.996	0.994	0.992	0.989	0.984	0.980	0.972	0.964	0.956	0.942
Wellhöfer IC 10	1.001	1.000	1.000	0.999	0.998	0.996	0.994	0.992	0.989	0.984	0.980	0.972	0.964	0.956	0.942
Wellhöfer IC 15	1.001	1.000	1.000	0.999	0.998	0.996	0.994	0.992	0.989	0.984	0.980	0.972	0.964	0.956	0.942
Wellhöfer IC 25	1.001	1.000	1.000	0.999	0.998	0.996	0.994	0.992	0.989	0.984	0.980	0.972	0.964	0.956	0.942
Wellhöfer IC 28 Farmer shortened	1.001	1.000	1.000	0.999	0.998	0.996	0.994	0.992	0.989	0.985	0.980	0.973	0.965	0.956	0.943
Wellhöfer IC 69 Farmer	1.002	1.002	1.000	0.999	0.997	0.994	0.991	0.989	0.985	0.981	0.977	0.969	0.961	0.953	0.940
Wellhöfer IC 70 Farmer	1.004	1.003	1.001	1.000	0.998	0.996	0.993	0.991	0.988	0.985	0.981	0.974	0.967	0.959	0.946

^a Some of the chambers listed in this table fail to meet some of the minimum requirements described in Section 4.2.1. However, they have been included in this table because of their current clinical use.

6.5.2. Chamber calibrated in a series of photon beam qualities

For a chamber calibrated in a series of photon beam qualities, the data from the calibration laboratory will ideally be presented in the form of a single calibration factor N_{D,w,Q_o} and a set of measured factors k_{Q,Q_o} . From the latter, a value for k_{Q,Q_o} at the user quality Q may be derived by interpolation. N_{D,w,Q_o} and the resulting k_{Q,Q_o} are then used directly in Eq. (6.1).

When the calibration laboratory provides a series of calibration factors $N_{D,w,Q}$, data must first be converted to the above format by choosing one of the photon beam qualities used by the calibration laboratory as reference quality, Q_o . The k_{Q,Q_o} factors are evaluated using

$$k_{Q,Q_o} = \frac{N_{D,w,Q}}{N_{D,w,Q_o}} \quad (6.2)$$

Interpolation to determine k_{Q,Q_o} at the user quality Q then proceeds as above. Note that when the reference quality Q_o is ^{60}Co , k_{Q,Q_o} is denoted by k_Q and N_{D,w,Q_o} is denoted by $N_{D,w}$.

Once experimental values for N_{D,w,Q_o} and k_{Q,Q_o} are obtained for a particular chamber, it may not be necessary for the user to calibrate the chamber every time at all qualities Q , but only at the single reference quality Q_o . In this case the new calibration factor N_{D,w,Q_o} should be used in conjunction with the existing values for k_{Q,Q_o} and the quality dependence of that chamber (k_{Q,Q_o} values) needs to be verified every third calibration cycle of the chamber or if the user suspects that the chamber has been damaged. The single calibration does not need to be performed at the same laboratory where the experimental k_{Q,Q_o} values were measured. Note, however, that this procedure should not be repeated more than twice in succession; the chamber should be re-calibrated at all qualities at least every six years.

6.5.3. Chamber calibrated at Q_o with generic experimental k_{Q,Q_o} values

Calibration laboratories sometimes provide generic experimental k_{Q,Q_o} values measured for a particular chamber type, together with a single experimental N_{D,w,Q_o} for the user chamber where the reference quality Q_o is usually ^{60}Co . Only those generic values of k_{Q,Q_o} that have been obtained by a standards laboratory from a large sample of ionization chambers and whose standard deviation of chamber-to-chamber differences is small are recommended for use in this Code of Practice (see Section 4.1). Generic values not determined by a standards laboratory are not recommended.

It is emphasized that directly measured values of k_{Q,Q_o} for an individual chamber within a given chamber type are the preferred choice in this Code of Practice, followed by the calculated values of k_{Q,Q_o} for a given chamber type given in Table 6.III. Note that if generic values for k_{Q,Q_o} (measured for a particular chamber type) exist, these should be used only if they meet the criteria expressed in Section 4.1.

6.6. Cross-calibration of field ionization chambers

As noted in Section 6.2.1, a field chamber may be cross-calibrated against a calibrated reference chamber at the reference quality Q_o . The chambers are compared by alternately placing the chambers in a water phantom with their reference points at z_{ref} (a side-by-side chamber intercomparison is a possible alternate configuration). The calibration factor in terms of absorbed dose to water for the field ionization chamber is given by

$$N_{D,w,Q_o}^{field} = \frac{M_{ref}}{M_{field}} N_{D,w,Q_o}^{ref} \quad (6.3)$$

where M_{ref} and M_{field} are the meter readings per monitor unit (MU) for the reference and field chambers, respectively, corrected for the influence quantities temperature and pressure, electrometer calibration, polarity effect and ion recombination as described in the Worksheet (see also Section 4.4.3) and N_{D,w,Q_o}^{ref} is the calibration factor in terms of absorbed dose to water for the reference chamber. Preferably, the readings M_{ref} and M_{field} should actually be the averages $\overline{M_{ref} / M_{em}}$ and $\overline{M_{field} / M_{em}}$, where $(M_{ref} / M_{em})_i$ and $(M_{field} / M_{em})_i$ are, respectively, the ratios of the reading of the reference detector and the field instrument to the reading of an external monitor. The external monitor should preferably be positioned inside the phantom approximately at the depth z_{ref} but at a distance of 3 to 4 cm away from the chamber centre along the major axis in the transverse plane of the beam. Note that in the case of a side-by-side measurement an external monitor is not needed provided that the beam profile is adequately uniform.

The field chamber with the calibration factor N_{D,w,Q_o}^{field} may be used subsequently for the determination of absorbed dose to water in the user beam using the procedure of Section 6.4.2 where N_{D,w,Q_o} is replaced by N_{D,w,Q_o}^{field} .

6.7. Measurements under non-reference conditions

Clinical dosimetry requires the measurements of central-axis percentage depth dose distributions (PDD), tissue-phantom ratios (TPR) or tissue-maximum ratios (TMR), isodose distributions, transverse beam profiles and output factors as a function of field size and shape for both reference and non-reference conditions. Such measurements should be made for all possible combinations of energy, field size and SSD or SAD used for radiotherapy treatment.

6.7.1. Central-axis depth-dose distributions

All measurements should follow the recommendations given in Section 4.2 regarding choices for phantoms and dosimeters, although other type of detectors can also be used. For measurements of depth-ionization curves, plane-parallel ionization chambers are recommended. If a cylindrical ionization chamber is used instead, then the effective point of measurement of the chamber must be taken into account. This requires that the complete depth-ionization distribution be shifted towards the surface a distance equal to $0.6 r_{cyl}$ [17, 21] where r_{cyl} is the cavity radius of the cylindrical ionization chamber. To make accurate measurements in the build-up region, extrapolation chambers or well-guarded fixed separation plane-parallel chambers should be used. Attention should be paid to the use of certain solid state detectors (some types of diodes and diamond detectors) to measure depth-dose distributions (see for instance, Ref. [21]); only a solid state detector whose response has been regularly verified against a reference detector (ionization chamber) should be selected for these measurements.

Since the stopping-power ratios and perturbation effects can be assumed to a reasonable accuracy to be independent of depth for a given beam quality and field size, relative ionization distributions can be used as relative distributions of absorbed dose, at least for depths at and beyond the depth of dose maximum.

6.7.2. Output factors

The output factor may be determined as the ratio of corrected dosimeter readings measured under a given set of non-reference conditions to that measured under reference conditions. These

measurements are typically done at the depth of maximum dose or at the reference depth [77] and corrected to the depth of maximum dose using percentage depth-dose data (or TMR). When output factors are measured in open as well as wedged beams, special attention should be given to the uniformity of the radiation fluence over the chamber cavity. This is especially important for field sizes smaller than 5 cm x 5 cm. Some accelerators have very pronounced V-shaped photon beam profiles which usually vary with depth and field size. For large detectors it may be difficult to accurately correct for this variation. Thimble chambers with large cavity length and plane-parallel chambers with large collecting electrodes (see section 4.2.1 for chamber requirements) should therefore be avoided in situations where the beams have pronounced V-shaped profiles.

In wedged photon beams the radiation intensity varies strongly in the direction of the wedge. For output measurements in such beams the detector dimension in the wedge direction should be as small as possible. A small thimble chamber aligned with its axis perpendicular to the wedge direction is recommended. The coincidence of the central axes of the beam, the collimator and the wedge should be ensured prior to making the output measurements.

6.8. Estimated uncertainty in the determination of absorbed dose to water under reference conditions

When a reference dosimeter is used for the determination of absorbed dose to water in the user beam, the uncertainties in the different physical quantities or procedures that contribute to the dose determination can be divided into two steps. Step 1 considers uncertainties up to the calibration of the user reference dosimeter in terms of $N_{D,w}$ at the standards laboratory. Step 2 deals with the calibration of the user beam and includes the uncertainties associated with the measurements at the reference point in a water phantom. Step 2 also includes the uncertainty of the k_Q value. The uncertainties of the factors that contribute to the uncertainty of calculated k_Q values can be found in Appendix B. Combining the uncertainties in quadrature in the various steps yields the combined standard uncertainty for the determination of the absorbed dose to water at the reference point.

An estimate of the uncertainties in the calibration of a high-energy photon beam is given in Table 6.IV. When the calibration of the reference dosimeter is carried out in the ^{60}Co beam of a SSDL, the combined standard uncertainty in D_w is estimated to be typically about 1.5%, based on calculated values of k_Q . This estimate may vary depending on the uncertainty quoted by the calibration laboratory. If the calibration of the reference dosimeter is carried out at a PSDL, but calculated values of k_Q are used, the final uncertainty in D_w is not expected to decrease as it is dominated by the uncertainty in the k_Q values. If these values are measured at the PSDL for the user chamber, the uncertainty in D_w decreases to about 1.2%. If a field dosimeter is used, the uncertainty in dose determination increases somewhat (by approximately 0.2%) because of the additional step needed to cross-calibrate the field dosimeter against the calibrated reference dosimeter.

TABLE 6.IV. ESTIMATED RELATIVE STANDARD UNCERTAINTY ^a OF $D_{w,Q}$ AT THE REFERENCE DEPTH IN WATER AND FOR A HIGH-ENERGY PHOTON BEAM, BASED ON A CHAMBER CALIBRATION IN ⁶⁰Co GAMMA RADIATION

Physical quantity or procedure	Relative standard uncertainty (%)
<i>Step 1: Standards Laboratory</i> ^b	
$N_{D,w}$ calibration of secondary standard at PSDL	0.5
Long term stability of secondary standard	0.1
$N_{D,w}$ calibration of the user dosimeter at the standard laboratory	0.4
<i>Combined uncertainty of Step 1</i>	<i>0.6</i>
<i>Step 2: User high-energy photon beam</i>	
Long-term stability of user dosimeter	0.3
Establishment of reference conditions	0.4
Dosimeter reading M_Q relative to beam monitor	0.6
Correction for influence quantities k_i	0.4
Beam quality correction k_Q (calculated values)	1.0 ^c
<i>Combined uncertainty of Step 2</i>	<i>1.4</i>
Combined standard uncertainty of $D_{w,Q}$ (Steps 1 + 2)	1.5

^a See ISO Guide to the expression of uncertainty [32] or Appendix D. The estimates given in the table should be considered typical values; these may vary depending on the uncertainty quoted by standards laboratories for calibration factors and on the experimental uncertainty at the user institution.

^b If the calibration of the user dosimeter is performed at a PSDL then the combined standard uncertainty in Step 1 is lower. The combined standard uncertainty in D_w should be adjusted accordingly.

^c If k_Q is measured at a PSDL for the user chamber, this uncertainty is approximately of the order of 0.7%

6.9. Worksheet

Determination of the absorbed dose to water in a high-energy photon beam

User: _____ Date: _____

1. Radiation treatment unit and reference conditions for $D_{w,Q}$ determination

Accelerator: _____ Nominal Acc Potential: _____ MV
 Nominal dose rate: _____ MU min⁻¹ Beam quality, Q ($TPR_{20,10}$): _____
 Reference phantom: water Set up: SSD SAD
 Reference field size: 10x10 cm x cm Reference distance (cm): _____
 Reference depth z_{ref} : _____ g cm⁻²

2. Ionization chamber and electrometer

Ionization chamber model: _____ Serial no.: _____
 Chamber wall material: _____ thickness: _____ g cm⁻²
 Waterproof sleeve material: _____ thickness: _____ g cm⁻²
 Phantom window material: _____ thickness: _____ g cm⁻²
Absorbed-dose-to-water calibration factor ^a N_{D,w,Q_0} = _____ Gy nC⁻¹ Gy rdg⁻¹
 Calibration quality Q_0 : ⁶⁰Co photon beam Calibration depth: _____ g cm⁻²
 If Q_0 is photon beam, give $TPR_{20,10}$: _____
 Reference conditions for calibration P_o : _____ kPa T_o : _____ °C Rel. humidity: _____ %
 Polarizing potential V_I : _____ V Calibration polarity: +ve -ve corrected for polarity effect
 User polarity: +ve -ve
 Calibration laboratory: _____ Date: _____
 Electrometer model: _____ Serial no.: _____
 Calibrated separately from chamber: yes no Range setting: _____
 If yes Calibration laboratory: _____ Date: _____

3. Dosimeter reading ^b and correction for influence quantities

Uncorrected dosimeter reading at V_I and user polarity: _____ nC rdg
 Corresponding accelerator monitor units: _____ MU
 Ratio of dosimeter reading and monitor units: M_I = _____ nC MU⁻¹ rdg MU⁻¹
 (i) Pressure P : _____ kPa Temperature T : _____ °C Rel. humidity (if known): _____ %

$$k_{TP} = \frac{(273.2 + T) P_o}{(273.2 + T_o) P} = \underline{\hspace{2cm}}$$

 (ii) Electrometer calibration factor ^c k_{elec} : nC rdg⁻¹ dimensionless $k_{elec} = \underline{\hspace{2cm}}$
 (iii) Polarity correction ^d rdg at $+V_I$: M_+ = _____ rdg at $-V_I$: M_- = _____

$$k_{pol} = \frac{|M_+| + |M_-|}{2M} = \underline{\hspace{2cm}}$$

(iv) Recombination correction (two-voltage method)

Polarizing voltages: V_1 (normal) = _____ V V_2 (reduced) = _____ V

Readings^e at each V: M_1 = _____ M_2 = _____

Voltage ratio V_1 / V_2 = _____ Ratio of readings M_1 / M_2 = _____

Use Table 4.VII for a beam of type: pulsed pulsed-scanned

a_0 = _____ a_1 = _____ a_2 = _____

$$k_s = a_0 + a_1 \left(\frac{M_1}{M_2} \right) + a_2 \left(\frac{M_1}{M_2} \right)^2 = \text{_____} \quad \text{f, g}$$

Corrected dosimeter reading at the voltage V_1 :

$$M_Q = M_1 k_{TP} k_{elec} k_{pol} k_s = \text{_____} \quad \square \text{ nC MU}^{-1} \quad \square \text{ rdg MU}^{-1}$$

4. Absorbed dose to water at the reference depth, z_{ref}

Beam quality correction factor for user quality Q : k_{Q,Q_0} = _____

taken from Table 6.III Other, specify: _____

$$D_{w,Q}(z_{ref}) = M_Q N_{D,w,Q_0} k_{Q,Q_0} = \text{_____ Gy MU}^{-1}$$

5. Absorbed dose to water at the depth of dose maximum, z_{max}

Depth of dose maximum: z_{max} = _____ g cm⁻²

(i) SSD set-up

Percentage depth-dose at z_{ref} for a 10 cm x 10 cm field size: $PDD(z_{ref} = \text{_____ g cm}^{-2}) = \text{_____} \%$

Absorbed-dose calibration of monitor at z_{max} :

$$D_{w,Q}(z_{max}) = 100 D_{w,Q}(z_{ref}) / PDD(z_{ref}) = \text{_____ Gy MU}^{-1}$$

(ii) SAD set-up

TMR at z_{ref} for a 10 cm x 10 cm field size: $TMR(z_{ref} = \text{_____ g cm}^{-2}) = \text{_____}$

Absorbed-dose calibration of monitor at z_{max} :

$$D_{w,Q}(z_{max}) = D_{w,Q}(z_{ref}) / TMR(z_{ref}) = \text{_____ Gy MU}^{-1}$$

^a Note that if Q_0 is ⁶⁰Co, N_{D,w,Q_0} is denoted by $N_{D,w}$.

^b All readings should be checked for leakage and corrected if necessary

^c If the electrometer is not calibrated separately set $k_{elec} = 1$

^d M in the denominator of k_{pol} denotes reading at the user polarity. Preferably, each reading in the equation should be the average of the ratios of M (or M_+ or M_-) to the reading of an external monitor, M_{em} .

It is assumed that the calibration laboratory has performed a polarity correction. Otherwise k_{pol} is determined according to

rdg at $+V_1$ for quality Q_0 : $M_+ = \text{_____}$ rdg at $-V_1$ for quality Q_0 : $M_- = \text{_____}$

$$k_{pol} = \frac{[(|M_+| + |M_-|) / |M|]_{Q_0}}{[(|M_+| + |M_-|) / |M|]_{Q_0}} = \text{_____}$$

^e Strictly, readings should be corrected for polarity effect (average with both polarities). Preferably, each reading in the equation should be the average of the ratios of M_1 or M_2 to the reading of an external monitor, M_{em} .

^f It is assumed that the calibration laboratory has performed a recombination correction. Otherwise the factor $k'_s = k_s / k_{s,Q_0}$ should be used instead of k_s . When Q_0 is ⁶⁰Co, k_{s,Q_0} (at the calibration laboratory) will normally be close to unity and the effect of not using this equation will be negligible in most cases.

^g Check that $k_s - 1 \approx \frac{M_1/M_2 - 1}{V_1/V_2 - 1}$

^h Note that if Q_0 is ⁶⁰Co, k_{Q,Q_0} is denoted by k_Q , as given in Table 6.III.

7. CODE OF PRACTICE FOR HIGH-ENERGY ELECTRON BEAMS

7.1. General

This Section provides a Code of Practice for reference dosimetry (beam calibration) and recommendations for relative dosimetry in clinical electron beams with energies in the range from 3 MeV to 50 MeV. It is based upon a calibration factor in terms of absorbed dose to water N_{D,w,Q_0} for a dosimeter in a reference beam of quality Q_0 . This reference quality may be either ^{60}Co gamma radiation or an electron beam quality. In the latter case the dosimeter may be calibrated either directly at a standards laboratory or by cross-calibration in a clinical electron beam.

Aside from having its foundation on standards of absorbed dose, the most significant change from current practice is the use of a new reference depth. This depth has been shown to reduce significantly the influence of spectral differences between different accelerators as well as that of electron and photon contamination in clinical electron beams [21, 91]. For simplicity, beam qualities and all factors dependent on beam quality (including the new reference depth) are expressed in terms of the half-value depth R_{50} rather than beam energy. This change parallels the longstanding practice in photon dosimetry where beam qualities are expressed in terms of the penetration of the beam.

7.2. Dosimetry equipment

7.2.1. Ionization chambers

The recommendations regarding ionization chambers given in Section 4.2.1 should be followed. Plane-parallel chambers are the recommended type for all beam qualities and must be used for beam qualities $R_{50} < 4 \text{ g cm}^{-2}$ ($E_0 \lesssim 10 \text{ MeV}$)²⁶. Ideally, the chamber should be calibrated in an electron beam, either directly at a standards laboratory or by cross-calibration in a clinical electron beam. The reference point for plane-parallel chambers is taken to be on the inner surface of the entrance window, at the centre of the window. This point should be positioned at the point of interest in the phantom. Chamber window thicknesses (in mm and in mg cm^{-2}) for a variety of plane-parallel chamber types are given in Table 4.II.

For beam qualities $R_{50} \geq 4 \text{ g cm}^{-2}$ ($E_0 \geq 10 \text{ MeV}$) cylindrical chambers may be used. The reference point for cylindrical chambers is taken to be on the chamber axis at the centre of the cavity volume. For measurements in electron beams this reference point should be positioned a distance $0.5 r_{cyl}$ deeper than the point of interest in the phantom, where r_{cyl} is the radius of the air cavity²⁷. Values for r_{cyl} for a variety of cylindrical chamber types are given in Table 4.I.

7.2.2. Phantoms and chamber sleeves

The recommendations regarding phantoms and chamber sleeves given in Sections 4.2.3 and 4.2.4 should be followed, both for determination of absorbed dose and for beam quality specification. Water is recommended as the reference medium for measurements in electron beams. The water phantom should extend to at least 5 cm beyond all four sides of the largest field size employed at the depth of measurement. There should also be a margin of at least 5 g cm^{-2} beyond the maximum depth of measurement.

²⁶ The approximate relation $E_0 = 2.33 R_{50}$, is assumed, where E_0 is the mean energy at the phantom surface in MeV and R_{50} is expressed in g cm^{-2} . The value stated for R_{50} takes precedence over that stated for E_0 .

²⁷ As with the concept of 'effective point of measurement' (see Section 1.6) positioning the chamber in this way is used to avoid the need for a fluence gradient correction. This is of particular significance because, in common with TRS-277 [17] and TRS-381 [21], the reference depth as defined in this Code of Practice does not always coincide with that of the dose maximum.

In a horizontal electron beam, the window of the phantom should be of plastic and of thickness t_{win} between 0.2 cm and 0.5 cm²⁸. The water-equivalent thickness of the phantom window (in g cm⁻²) should be taken into account when positioning the chamber at the desired measurement depth. This thickness is calculated as the product $t_{win} \rho_{pl}$, where ρ_{pl} is the density of the plastic (in g cm⁻³). For the commonly used plastics PMMA and clear polystyrene, the nominal values $\rho_{PMMA} = 1.19 \text{ g cm}^{-3}$ and $\rho_{polystyrene} = 1.06 \text{ g cm}^{-3}$ may be used [66].

Under certain circumstances and for beam qualities $R_{50} < 4 \text{ g cm}^{-2}$ ($E_0 \lesssim 10 \text{ MeV}$) a plastic phantom may be used; all depths must then be appropriately scaled (see Sections 4.2.3 and 7.8)²⁹.

Plane-parallel chambers, if not inherently waterproof or supplied with a waterproof cover, should be used in a waterproof enclosure, preferably of PMMA or a material that matches the chamber walls. Ideally, there should be no more than 1 mm of added material in front of and behind the air cavity. Cylindrical chambers should be used in a PMMA sleeve, preferably not thicker than 1.0 mm. The air gap between the chamber wall and the sleeve should be sufficient (0.1 mm to 0.3 mm) to allow the air pressure in the chamber to follow the ambient air pressure. For both chamber types, the same (or similar) waterproofing should be used for the determination of absorbed dose to water at the user facility as was used for calibration at the standards laboratory.

Strictly, when used in conjunction with the calculated values for k_{Q,Q_0} given in this Section, the water-equivalent thickness (in g cm⁻²) of the chamber wall and any waterproofing material should be taken into account when positioning the chamber at the point of interest. However, this is a very small effect and may be ignored in practice. For general comments on the positioning of chambers, see Section 4.2.5.

7.3. Beam quality specification

7.3.1. Choice of beam quality index

For electron beams the beam quality index is the half-value depth in water R_{50} . This is the depth in water (in g cm⁻²) at which the absorbed dose is 50% of its value at the absorbed-dose maximum, measured with a constant SSD of 100 cm and a field size at the phantom surface of at least 10 cm x 10 cm for $R_{50} \leq 7 \text{ g cm}^{-2}$ ($E_0 \lesssim 16 \text{ MeV}$) and at least 20 cm x 20 cm for $R_{50} > 7 \text{ g cm}^{-2}$ ($E_0 \gtrsim 16 \text{ MeV}$). As noted in TRS-381 [21], some accelerators at high electron energies have an intrinsic poor homogeneity at large field sizes which may improve at smaller field sizes as a result of electrons scattered from the collimator (or applicator, cones, etc). In such cases a field size smaller than 20 cm x 20 cm may be used provided that R_{50} does not change by more than around 0.1 g cm⁻² from the value measured for a 20 cm x 20 cm field.

The choice of R_{50} as the beam quality index is a change from the current practice of specifying beam quality in terms of the mean energy at the phantom surface E_0 . As E_0 is normally derived from R_{50} this change in beam quality index is merely a simplification which avoids the need for a conversion to energy.

7.3.2. Measurement of beam quality

The reference conditions for the determination of R_{50} are given in Table 7.I.

For all beam qualities, the preferred choice of detector for the measurement of R_{50} is a plane-parallel chamber. For beam qualities $R_{50} \geq 4 \text{ g cm}^{-2}$ ($E_0 \gtrsim 10 \text{ MeV}$) a cylindrical chamber may be used, with the reference point positioned $0.5 r_{cyl}$ deeper than the point of interest in the phantom. A water phantom is the preferred choice. In a vertical beam the direction of scan should be towards the surface to reduce the effect

²⁸ A window of only a few mm in thickness may bow outwards slightly due to water pressure on the inner surface. Any such effect should be accounted for when positioning the chamber at the depth of interest, particularly in low-energy electron beams.

²⁹ Plastic phantoms can be used for routine quality assurance measurements, provided a transfer factor between plastic and water has been established at the time of beam calibration.

of meniscus formation. For beam qualities $R_{50} < 4 \text{ g cm}^{-2}$ ($E_0 \lesssim 10 \text{ MeV}$) a plastic phantom may be used, in which case all depths must be scaled according to the procedure described in Section 7.8.

Ion recombination and polarity corrections are required at all depths (see Section 4.4.3). These may be derived from a reduced set of representative measurements, for example near the surface, the ionization maximum and the depths corresponding to 90% and 50% of the ionization maximum. For measurements made over a short period of time, air temperature and pressure corrections need not be made.

TABLE 7.I REFERENCE CONDITIONS FOR THE DETERMINATION OF ELECTRON BEAM QUALITY (R_{50})

Influence quantity	Reference value or reference characteristics
Phantom material	for $R_{50} \geq 4 \text{ g cm}^{-2}$, water. For $R_{50} < 4 \text{ g cm}^{-2}$, water or plastic
Chamber type	for $R_{50} \geq 4 \text{ g cm}^{-2}$, plane-parallel or cylindrical. For $R_{50} < 4 \text{ g cm}^{-2}$, plane parallel
Reference point of chamber	for plane-parallel chambers, on the inner surface of the window at its centre. For cylindrical chambers, on the central axis at the centre of the cavity volume
Position of reference point of chamber	for plane-parallel chambers, at the point of interest. For cylindrical chambers, $0.5 r_{cyl}$ deeper than the point of interest
SSD	100 cm
Field size at phantom surface	for $R_{50} \leq 7 \text{ g cm}^{-2}$, at least 10 cm x 10 cm. For $R_{50} > 7 \text{ g cm}^{-2}$, at least 20 cm x 20 cm ^a

^a A field size smaller than 20 cm x 20 cm may be used provided that R_{50} does not change by more than around 0.1 g cm^{-2} from the value measured for a 20 cm x 20 cm field.

When using an ionization chamber, the measured quantity is the half-value of the depth-ionization distribution in water, $R_{50,ion}$. This is the depth in water (in g cm^{-2}) at which the ionization current is 50% of its maximum value. The half-value of the depth-dose distribution in water R_{50} is obtained using [92]

$$R_{50} = 1.029 R_{50,ion} - 0.06 \text{ g cm}^{-2} \quad (R_{50,ion} \leq 10 \text{ g cm}^{-2}) \quad (7.1)$$

$$R_{50} = 1.059 R_{50,ion} - 0.37 \text{ g cm}^{-2} \quad (R_{50,ion} > 10 \text{ g cm}^{-2})$$

As an alternative to the use of an ionization chamber, other detectors (for example diode, diamond, etc.) may be used to determine R_{50} . In this case the user must verify that the detector is suitable for depth-dose measurements by test comparisons with an ionization chamber at a set of representative beam qualities.

7.4. Determination of absorbed dose to water

7.4.1. Reference conditions

The reference conditions for determination of absorbed dose to water in electron beams are given in Table 7.II. Because the precise choice of field size is not critical [21], a convenient choice for the reference field size is that which is used for the normalization of output factors, subject to the constraint that it should not be less than 10 cm x 10 cm at the phantom surface. The reference depth z_{ref} is given by [91]

$$z_{ref} = 0.6 R_{50} - 0.1 \text{ g cm}^{-2} \quad (R_{50} \text{ in } \text{g cm}^{-2}) \quad (7.2)$$

This depth is close to the depth of the absorbed-dose maximum z_{max} at beam qualities $R_{50} < 4 \text{ g cm}^{-2}$ ($E_0 \lesssim 10 \text{ MeV}$), but at higher beam qualities is deeper than z_{max} . It is recognized that this choice of reference depth may be less convenient than that recommended in TRS-277 [17], since for a given accelerator no two reference beams will have the same reference depth. However, the new depth has been shown to significantly reduce machine-to-machine variations in chamber calibration factors [91] and the accuracy gained justifies its use, particularly for plane-parallel chamber types.

It should be noted that by recommending that reference dosimetry at higher energies be conducted at a depth beyond z_{max} , the uncertainty arising from cavity perturbation effects for cylindrical chambers may be larger. In the worst case, around $R_{50} = 5 \text{ g cm}^{-2}$ (E_o around 12 MeV) the increased uncertainty is approximately 0.3%.

7.4.2. Determination of absorbed dose under reference conditions

The general formalism is given in Section 3. The absorbed dose to water at the reference depth z_{ref} in water, in an electron beam of quality Q and in the absence of the chamber, is given by

$$D_{w,Q} = M_Q N_{D,w,Q_o} k_{Q,Q_o} \quad (7.3)$$

where M_Q is the reading of the dosimeter corrected for the influence quantities temperature and pressure, electrometer calibration, polarity effect and ion recombination as described in the Worksheet (see also Section 4.4.3). The chamber should be positioned in accordance with the reference conditions, as given in Table 7.II. N_{D,w,Q_o} is the calibration factor in terms of absorbed dose to water for the dosimeter at the reference quality Q_o and k_{Q,Q_o} is a chamber-specific factor which corrects for differences between the reference beam quality Q_o and the actual beam quality Q .

TABLE 7.II. REFERENCE CONDITIONS FOR THE DETERMINATION OF ABSORBED DOSE IN ELECTRON BEAMS

Influence quantity	Reference value or reference characteristic
Phantom material	for $R_{50} \geq 4 \text{ g cm}^{-2}$, water. For $R_{50} < 4 \text{ g cm}^{-2}$, water or plastic
Chamber type	for $R_{50} \geq 4 \text{ g cm}^{-2}$, plane-parallel or cylindrical. For $R_{50} < 4 \text{ g cm}^{-2}$, plane parallel
Measurement depth z_{ref}	$0.6 R_{50} - 0.1 \text{ g cm}^{-2}$
Reference point of chamber	for plane-parallel chambers, on the inner surface of the window at its centre. For cylindrical chambers, on the central axis at the centre of the cavity volume
Position of reference point of chamber	for plane-parallel chambers, at z_{ref} . For cylindrical chambers, $0.5 r_{cyl}$ deeper than z_{ref}
SSD	100 cm
Field size at phantom surface	10 cm x 10 cm or that used for normalization of output factors, whichever is larger

7.4.3. Absorbed dose at z_{max}

Clinical normalization most often takes place at the depth of the dose maximum z_{max} which, in the present Code of Practice, does not always coincide with z_{ref} . To determine the absorbed dose at z_{max} the user should, for a given beam, use the measured central-axis depth-dose distribution to convert the absorbed dose at z_{ref} to that at z_{max} . The measurement of depth-dose distributions is discussed in Section 7.7.1.

7.5. Values for k_{Q,Q_o}

The general formalism is given in Section 3. The modified treatment of k_{Q,Q_o} for chambers cross-calibrated in a user electron beam, as described in Section 3.2.1, is dealt with in Section 7.6, which may also be applied to chambers calibrated directly at a standards laboratory at a single electron beam quality. The stopping-power ratios and perturbation factors used in the calculation of k_{Q,Q_o} are described in Appendix B.

7.5.1. Chamber calibrated in ^{60}Co

When the reference quality Q_o is ^{60}Co , the factor k_{Q,Q_o} is denoted by k_Q . Calculated values for k_Q are given in Table 7.III for a series of user qualities Q and for a number of chamber types; values for non-tabulated

qualities may be obtained by interpolation. These data are also presented in Figures 7.1 and 7.2 for plane-parallel and cylindrical chamber types, respectively. Note that if generic values for k_{Q,Q_0} (measured for a particular chamber type) exist, these should be used only if they meet the criteria expressed in Section 4.1.

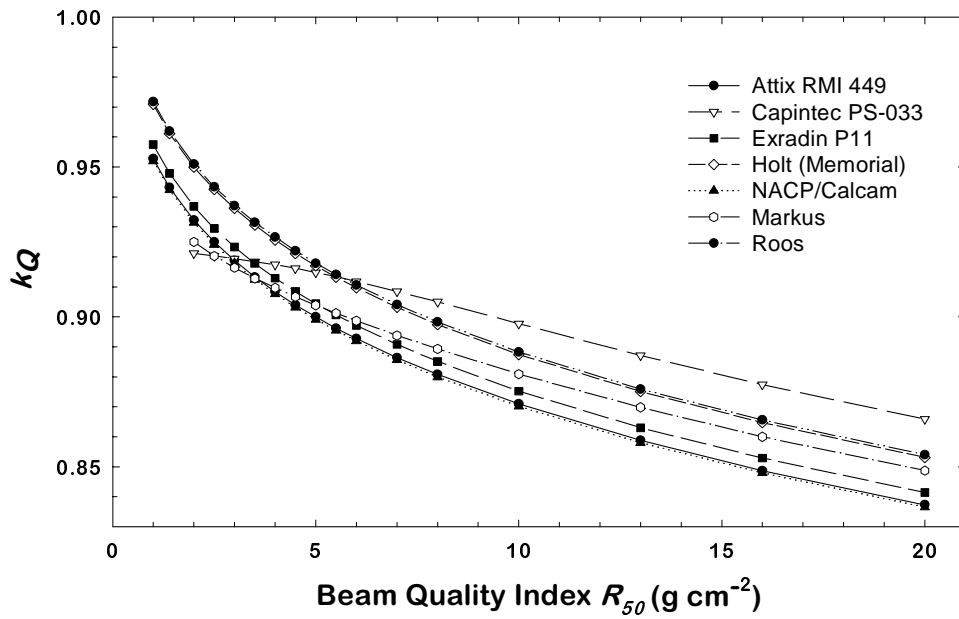

Figure 7.1. Calculated k_Q values for electron beams, for various plane-parallel chamber types calibrated in ^{60}Co gamma radiation.

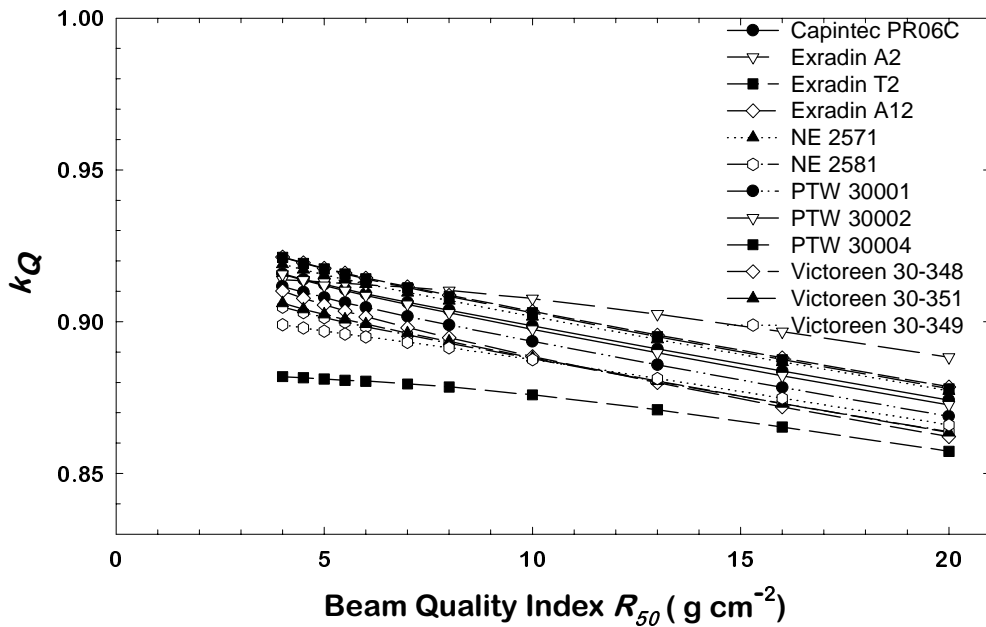

Figure 7.2. Calculated k_Q values for electron beams, for various cylindrical chamber types calibrated in ^{60}Co gamma radiation.

7.5.2. Chamber calibrated at a series of electron beam qualities

For a chamber calibrated at a series of electron beam qualities, the data from the calibration laboratory will ideally be presented as a single calibration factor N_{D,w,Q_o} determined in a reference electron beam of quality Q_o and one or more measured factors k_{Q,Q_o} corresponding to the other calibration qualities Q .

However, if the calibration data are in the form of a set of calibration factors $N_{D,w,Q}$ then one of the calibration qualities³⁰ should be chosen as the reference calibration quality Q_o . The corresponding calibration factor is denoted N_{D,w,Q_o} and the remaining calibration factors $N_{D,w,Q}$ are expressed as a series of factors k_{Q,Q_o} using the relation

$$k_{Q,Q_o} = \frac{N_{D,w,Q}}{N_{D,w,Q_o}} \quad (7.4)$$

If the quality of the user beam Q does not match any of the calibration qualities, the value for k_{Q,Q_o} to be used in Eq. (7.3) can be obtained by interpolation.

A chamber calibrated at a series of beam qualities may be subsequently recalibrated at only the reference calibration quality Q_o . In this case, the new value for N_{D,w,Q_o} should be used in conjunction with the values for k_{Q,Q_o} measured previously. Note, however, that this procedure should not be repeated more than twice in succession; the chamber should be recalibrated at all qualities at least every six years³¹ or if the user suspects that the chamber has been damaged.

7.6. Cross-calibration of ionization chambers

Cross-calibration refers to the calibration of a user chamber by direct comparison in a suitable user beam against a reference chamber that has previously been calibrated. A particular example of this is the cross-calibration of a plane-parallel chamber for use in electron beams against a reference cylindrical chamber calibrated in ^{60}Co gamma radiation. Despite the additional step, such a cross-calibration generally results in a determination of absorbed dose to water using the plane-parallel chamber that is more reliable than that achieved by the use of a plane-parallel chamber calibrated directly in ^{60}Co , mainly because problems associated with the p_{wall} correction for plane-parallel chambers in ^{60}Co , entering into the determination of k_{Q,Q_o} , are avoided. The modified k_{Q,Q_o} factors to be used with a cross-calibrated chamber are described in Section 3.2.1.

7.6.1. Cross-calibration procedure

The highest-energy electron beam available should be used; $R_{50} > 7 \text{ g cm}^{-2}$ ($E_o > 16 \text{ MeV}$) is recommended. The reference chamber and the chamber to be calibrated are compared by alternately positioning each at the reference depth z_{ref} in water in accordance with the reference conditions for each (see Table 7.II). The calibration factor in terms of absorbed dose to water for the chamber under calibration, at the cross-calibration quality Q_{cross} , is given by

$$N_{D,w,Q_{cross}}^x = \frac{M_{Q_{cross}}^{ref}}{M_{Q_{cross}}^x} N_{D,w,Q_o}^{ref} k_{Q_{cross},Q_o}^{ref} \quad (7.5)$$

³⁰ The choice here is not critical; the quality corresponding to the $N_{D,w,Q}$ factor with the smallest relative uncertainty is appropriate, otherwise a quality close to the middle of the range.

³¹ As noted in Section 4.3, this procedure should not be used for chambers whose stability has not been demonstrated over a period exceeding five years.

where $M_{Q_{cross}}^{ref}$ and $M_{Q_{cross}}^x$ are the dosimeter readings for the reference chamber and the chamber under calibration, respectively, corrected for the influence quantities temperature and pressure, electrometer calibration, polarity effect and ion recombination as described in Section 4.4.3. N_{D,w,Q_o}^{ref} is the calibration factor in terms of absorbed dose to water for the reference chamber at quality Q_o and k_{Q_{cross},Q_o}^{ref} is the beam quality correction factor for the reference chamber.

In practice, to minimize the effect of any variation in the accelerator output, the readings $M_{Q_{cross}}^{ref}$ and $M_{Q_{cross}}^x$ should be the averages $\overline{M_{Q_{cross}}^{ref} / M_{Q_{cross}}^{em}}$ and $\overline{M_{Q_{cross}}^x / M_{Q_{cross}}^{em}}$, respectively, measured relative to an external monitor. The external monitor should ideally be positioned inside the phantom at the reference depth z_{ref} but displaced laterally a distance of 3 cm or 4 cm from the chamber centre.

Normally, the calibration quality Q_o for the reference chamber will be ^{60}Co and the value for k_{Q_{cross},Q_o}^{ref} is derived from Table 7.III. In the event that Q_o is a high-energy electron beam, the value for k_{Q_{cross},Q_o}^{ref} must be derived using the procedure of Section 3.2.1;

$$k_{Q_{cross},Q_o}^{ref} = \frac{k_{Q_{cross},Q_{int}}^{ref}}{k_{Q_o,Q_{int}}^{ref}} \quad (7.6)$$

where $k_{Q_{cross},Q_{int}}^{ref}$ and $k_{Q_o,Q_{int}}^{ref}$ are taken from Table 7.IV.

7.6.2. Subsequent use of a cross-calibrated chamber

The cross-calibrated chamber with calibration factor $N_{D,w,Q_{cross}}^x$ may be used subsequently for the determination of absorbed dose in a user beam of quality Q using the basic Eq. (7.3);

$$D_{w,Q} = M_Q^x N_{D,w,Q_{cross}}^x k_{Q,Q_{cross}}^x \quad (7.7)$$

The values for $k_{Q,Q_{cross}}^x$ are derived using the procedure of Section 3.2.1;

$$k_{Q,Q_{cross}}^x = \frac{k_{Q,Q_{int}}^x}{k_{Q_{cross},Q_{int}}^x} \quad (7.8)$$

where $k_{Q,Q_{int}}^x$ and $k_{Q_{cross},Q_{int}}^x$ are taken from Table 7.IV. Note that the above may also be used for chambers calibrated at a standards laboratory at a single electron beam quality Q_{cross} .

TABLE 7.III. CALCULATED VALUES FOR k_Q FOR ELECTRON BEAMS, FOR VARIOUS CHAMBER TYPES CALIBRATED IN ^{60}Co GAMMA RADIATION, AS A FUNCTION OF BEAM QUALITY R_{50}

(The data are derived using values for stopping-power ratios and perturbation factors as given in Appendix B.)

Ionization chamber type ^a	Beam quality R (g cm^{-2})																	
	1.0	1.4	2.0	2.5	3.0	3.5	4.0	4.5	5.0	5.5	6.0	7.0	8.0	10.0	13.0	16.0	20.0	
<i>Plane-parallel chambers</i>																		
Attix RMI 449	0.953	0.943	0.932	0.925	0.919	0.913	0.908	0.904	0.900	0.896	0.893	0.886	0.881	0.871	0.859	0.849	0.837	
Capintec PS-033	-	-	0.921	0.920	0.919	0.918	0.917	0.916	0.915	0.913	0.912	0.908	0.905	0.898	0.887	0.877	0.866	
Exradin P11	0.958	0.948	0.937	0.930	0.923	0.918	0.913	0.908	0.904	0.901	0.897	0.891	0.885	0.875	0.863	0.853	0.841	
Holt (Memorial)	0.971	0.961	0.950	0.942	0.936	0.931	0.926	0.921	0.917	0.913	0.910	0.903	0.897	0.887	0.875	0.865	0.853	
NACP / Calcam	0.952	0.942	0.931	0.924	0.918	0.912	0.908	0.903	0.899	0.895	0.892	0.886	0.880	0.870	0.858	0.848	0.836	
Markus	-	-	0.925	0.920	0.916	0.913	0.910	0.907	0.904	0.901	0.899	0.894	0.889	0.881	0.870	0.860	0.849	
Roos	0.965	0.955	0.944	0.937	0.931	0.925	0.920	0.916	0.912	0.908	0.904	0.898	0.892	0.882	0.870	0.860	0.848	
<i>Cylindrical chambers</i>																		
Capintec PR06C (Farmer)	-	-	-	-	-	-	0.916	0.914	0.912	0.911	0.909	0.906	0.904	0.899	0.891	0.884	0.874	
Exradin A2 (Spokas)	-	-	-	-	-	-	0.914	0.913	0.913	0.913	0.912	0.911	0.910	0.908	0.903	0.897	0.888	
Exradin T2 (Spokas)	-	-	-	-	-	-	0.882	0.881	0.881	0.881	0.880	0.879	0.878	0.876	0.871	0.865	0.857	
Exradin A12 (Farmer)	-	-	-	-	-	-	0.921	0.919	0.918	0.916	0.914	0.911	0.909	0.903	0.896	0.888	0.878	
NE 2571 (Guarded Farmer)	-	-	-	-	-	-	0.918	0.916	0.915	0.913	0.911	0.909	0.906	0.901	0.893	0.886	0.876	
NE 2581 (Robust Farmer)	-	-	-	-	-	-	0.899	0.898	0.896	0.894	0.893	0.890	0.888	0.882	0.875	0.868	0.859	
PTW 30001/30010 (Farmer)	-	-	-	-	-	-	0.911	0.909	0.907	0.905	0.904	0.901	0.898	0.893	0.885	0.877	0.868	
PTW 30002/30011 (Farmer)	-	-	-	-	-	-	0.916	0.914	0.912	0.910	0.909	0.906	0.903	0.897	0.890	0.882	0.873	
PTW 30004/30012 (Farmer)	-	-	-	-	-	-	0.920	0.918	0.916	0.915	0.913	0.910	0.907	0.902	0.894	0.887	0.877	
PTW 31002/31003 (flexible)	-	-	-	-	-	-	0.912	0.910	0.908	0.906	0.905	0.901	0.898	0.893	0.885	0.877	0.867	
Victoreen 30-348	-	-	-	-	-	-	0.910	0.908	0.906	0.903	0.902	0.898	0.895	0.888	0.880	0.872	0.862	
Victoreen 30-351	-	-	-	-	-	-	0.906	0.904	0.902	0.901	0.899	0.896	0.893	0.888	0.880	0.873	0.864	
Victoreen 30-349	-	-	-	-	-	-	0.899	0.898	0.897	0.896	0.895	0.893	0.891	0.888	0.881	0.875	0.866	

^a Some of the chambers listed in this table fail to meet all of the minimum requirements described in Section 4.2.1. However, they have been included in this table because of their current clinical use.

TABLE 7.IV. CALCULATED VALUES FOR $k_{Q,0_{nt}}$ FOR VARIOUS CHAMBER TYPES CALIBRATED IN ELECTRON BEAMS, AS A FUNCTION OF BEAM QUALITY R_{50}

(The data are derived using values for stopping-power ratios and perturbation factors as given in Appendix B and taking the value $Q_{int} = 7.5 \text{ g cm}^{-2}$.)

Ionization chamber type ^a	Beam quality R_{50} (g cm ⁻²)																
	1.0	1.4	2.0	2.5	3.0	3.5	4.0	4.5	5.0	5.5	6.0	7.0	8.0	10.0	13.0	16.0	20.0
<i>Plane-parallel chambers</i>																	
Attix RMI 449	1.078	1.068	1.055	1.047	1.040	1.034	1.028	1.023	1.019	1.014	1.010	1.003	0.997	0.986	0.972	0.961	0.948
Capintec PS-033	-	-	1.016	1.015	1.014	1.013	1.012	1.010	1.009	1.007	1.006	1.002	0.998	0.990	0.978	0.968	0.955
Exradin P11	1.078	1.068	1.055	1.047	1.040	1.034	1.028	1.023	1.019	1.014	1.010	1.003	0.997	0.986	0.972	0.961	0.948
Holt (Memorial)	1.078	1.068	1.055	1.047	1.040	1.034	1.028	1.023	1.019	1.014	1.010	1.003	0.997	0.986	0.972	0.961	0.948
NACP / Calcam	1.078	1.068	1.055	1.047	1.040	1.034	1.028	1.023	1.019	1.014	1.010	1.003	0.997	0.986	0.972	0.961	0.948
Markus	-	-	1.038	1.032	1.028	1.024	1.020	1.017	1.014	1.011	1.008	1.003	0.997	0.988	0.976	0.965	0.952
Roos	1.078	1.068	1.055	1.047	1.040	1.034	1.028	1.023	1.019	1.014	1.010	1.003	0.997	0.986	0.972	0.961	0.948
<i>Cylindrical chambers</i>																	
Capintec PR06C (Farmer)	-	-	-	-	-	-	1.012	1.010	1.008	1.006	1.005	1.001	0.999	0.993	0.984	0.976	0.966
Exradin A2 (Spokas)	-	-	-	-	-	-	1.003	1.003	1.002	1.002	1.002	1.001	0.999	0.996	0.991	0.984	0.975
Exradin T2 (Spokas)	-	-	-	-	-	-	1.003	1.003	1.002	1.002	1.002	1.001	0.999	0.996	0.991	0.984	0.975
Exradin A12 (Farmer)	-	-	-	-	-	-	1.012	1.010	1.008	1.006	1.005	1.002	0.998	0.993	0.984	0.976	0.965
NE 2571 (Guarded Farmer)	-	-	-	-	-	-	1.012	1.010	1.008	1.006	1.005	1.001	0.999	0.993	0.984	0.976	0.966
NE 2581 (Robust Farmer)	-	-	-	-	-	-	1.012	1.010	1.008	1.006	1.005	1.001	0.999	0.993	0.984	0.976	0.966
PTW 30001/30010 (Farmer)	-	-	-	-	-	-	1.013	1.010	1.008	1.007	1.005	1.002	0.998	0.992	0.984	0.976	0.965
PTW 30002/30011 (Farmer)	-	-	-	-	-	-	1.013	1.010	1.008	1.007	1.005	1.002	0.998	0.992	0.984	0.976	0.965
PTW 30004/30012 (Farmer)	-	-	-	-	-	-	1.013	1.010	1.008	1.007	1.005	1.002	0.998	0.992	0.984	0.976	0.965
PTW 31002/31003 (flexible)	-	-	-	-	-	-	1.014	1.011	1.009	1.007	1.005	1.002	0.998	0.992	0.983	0.974	0.964
Victoreen 30-348	-	-	-	-	-	-	1.015	1.013	1.010	1.008	1.006	1.002	0.998	0.991	0.982	0.973	0.962
Victoreen 30-351	-	-	-	-	-	-	1.013	1.010	1.008	1.007	1.005	1.002	0.998	0.992	0.984	0.976	0.965
Victoreen 30-349	-	-	-	-	-	-	1.008	1.006	1.005	1.004	1.003	1.001	0.999	0.995	0.988	0.980	0.971

^a Some of the chambers listed in this table fail to meet all of the minimum requirements described in Section 4.2.1. However, they have been included in this table because of their current clinical use.

TABLE 7.V. SPENCER-ATTIX STOPPING-POWER RATIOS ($\Delta = 10$ keV) WATER TO AIR ($S_{w,air}$) FOR ELECTRON BEAMS, AS A FUNCTION OF BEAM QUALITY R_{50} AND RELATIVE DEPTH z/R_{50} IN WATER
 (*The data are derived using Eq (B.6) in Appendix B due to Burns et al [91].*)

z_{ref} ($g\ cm^{-2}$): $S_{w,air}(z_{ref})$	Beam quality R_{50} ($g\ cm^{-2}$)																
	1.0	1.4	2.0	2.5	3.0	3.5	4.0	4.5	5.0	5.5	6.0	7.0	8.0	10.0	13.0	16.0	20.0
0.02	1.076	1.060	1.042	1.030	1.020	1.012	1.004	0.997	0.991	0.986	0.980	0.971	0.963	0.950	0.935	0.924	0.914
0.05	1.078	1.061	1.044	1.032	1.022	1.014	1.006	1.000	0.994	0.988	0.983	0.974	0.965	0.952	0.937	0.926	0.916
0.10	1.080	1.064	1.047	1.036	1.026	1.018	1.010	1.004	0.998	0.992	0.987	0.978	0.970	0.957	0.942	0.931	0.920
0.15	1.083	1.067	1.050	1.039	1.030	1.022	1.014	1.008	1.002	0.997	0.992	0.983	0.975	0.961	0.946	0.935	0.924
0.20	1.085	1.070	1.053	1.043	1.034	1.026	1.019	1.012	1.006	1.001	0.996	0.987	0.979	0.966	0.951	0.940	0.929
0.25	1.088	1.073	1.057	1.046	1.037	1.030	1.023	1.017	1.011	1.006	1.001	0.992	0.984	0.971	0.956	0.945	0.933
0.30	1.091	1.076	1.060	1.050	1.041	1.034	1.027	1.021	1.016	1.010	1.006	0.997	0.989	0.976	0.961	0.950	0.938
0.35	1.093	1.079	1.064	1.054	1.045	1.038	1.032	1.026	1.020	1.015	1.011	1.002	0.995	0.982	0.966	0.955	0.943
0.40	1.096	1.082	1.067	1.058	1.049	1.042	1.036	1.030	1.025	1.020	1.016	1.007	1.000	0.987	0.972	0.960	0.948
0.45	1.099	1.085	1.071	1.062	1.054	1.047	1.041	1.035	1.030	1.025	1.021	1.013	1.006	0.993	0.978	0.966	0.953
0.50	1.102	1.089	1.075	1.066	1.058	1.051	1.046	1.040	1.035	1.031	1.027	1.019	1.012	0.999	0.984	0.971	0.959
0.55	1.105	1.092	1.078	1.070	1.062	1.056	1.051	1.045	1.041	1.036	1.032	1.025	1.018	1.005	0.990	0.977	0.964
0.60	1.108	1.095	1.082	1.074	1.067	1.061	1.056	1.051	1.046	1.042	1.038	1.031	1.024	1.012	0.996	0.984	0.970
0.65	1.111	1.099	1.086	1.078	1.072	1.066	1.061	1.056	1.052	1.048	1.044	1.037	1.030	1.018	1.003	0.990	0.976
0.70	1.114	1.102	1.090	1.082	1.076	1.071	1.066	1.062	1.058	1.054	1.050	1.043	1.037	1.025	1.010	0.997	0.983
0.75	1.117	1.105	1.094	1.087	1.081	1.076	1.072	1.067	1.064	1.060	1.057	1.050	1.044	1.033	1.017	1.004	0.989
0.80	1.120	1.109	1.098	1.091	1.086	1.081	1.077	1.073	1.070	1.066	1.063	1.057	1.051	1.040	1.025	1.012	0.996
0.85	1.123	1.112	1.102	1.096	1.091	1.087	1.083	1.080	1.076	1.073	1.070	1.064	1.059	1.048	1.033	1.019	1.004
0.90	1.126	1.116	1.107	1.101	1.096	1.092	1.089	1.086	1.083	1.080	1.077	1.072	1.067	1.056	1.041	1.028	1.011
0.95	1.129	1.120	1.111	1.106	1.102	1.098	1.095	1.092	1.090	1.087	1.085	1.080	1.075	1.065	1.050	1.036	1.019
1.00	1.132	1.124	1.115	1.111	1.107	1.104	1.101	1.099	1.097	1.095	1.092	1.088	1.083	1.074	1.059	1.045	1.028
1.05	1.136	1.127	1.120	1.116	1.113	1.110	1.108	1.106	1.104	1.102	1.100	1.096	1.092	1.083	1.069	1.055	1.037
1.10	1.139	1.131	1.125	1.121	1.118	1.116	1.115	1.113	1.112	1.110	1.109	1.105	1.102	1.093	1.079	1.065	1.046
1.15	1.142	1.135	1.129	1.126	1.124	1.123	1.122	1.120	1.119	1.118	1.117	1.114	1.111	1.104	1.090	1.075	1.056
1.20	1.146	1.139	1.134	1.132	1.130	1.129	1.129	1.128	1.128	1.127	1.126	1.124	1.121	1.115	1.101	1.086	1.066

Relative depth in
water z/R_{50}

7.7. Measurements under non-reference conditions

7.7.1. Central-axis depth-dose distributions

The measurement of a central-axis depth-dose distribution should follow the procedure given in Section 7.3.2 for the measurement of R_{50} . If an ionization chamber is used, the measured depth-ionization distribution must be converted to a depth-dose distribution³². For a beam of quality R_{50} , this is achieved by multiplying the ionization current or charge at each measurement depth z by the stopping-power ratio $s_{w,air}$ at that depth. Values for $s_{w,air}$ are given in Table 7.V as a function of R_{50} and the relative depth z / R_{50} . Linear interpolation between table entries is sufficient. These stopping-power ratios are calculated using Eq. (B.6) in Appendix B³³.

Note that this procedure neglects any variation in the perturbation factor with depth. This is a good approximation for well guarded plane-parallel chamber types. For plane parallel chambers that are not well guarded and for cylindrical chamber types, changes in the perturbation factor are significant and must be accounted for. Unfortunately, the existing data on perturbation factors for these chamber types have been verified only at depths close to the reference depth and are therefore not suitable for use at other depths, despite their common use at these depths. The use of these chambers to determine the depth-dose distribution is therefore discouraged.

7.7.2. Output factors

For a given electron beam, output factors should be measured at z_{max} for the non-reference field sizes and SSDs used for the treatment of patients. Output factors may be determined as the absorbed dose at z_{max} for a given set of non-reference conditions relative to the absorbed dose at z_{ref} (or z_{max}) under the appropriate reference conditions. Users should be aware of the variation of the depth of maximum dose, z_{max} , particularly for small field sizes and high energies.

For detectors such as diodes, diamonds, etc. the output factor will be adequately approximated by the detector reading under the non-reference conditions relative to that under reference conditions. If an ionization chamber is used, the measured ratio of corrected ionization currents or charges should be corrected for the variation in $s_{w,air}$ with depth, using Table 7.V. The same considerations noted in Section 7.7.1 regarding perturbation effects also apply here.

7.8. Use of plastic phantoms

Plastic phantoms may only be used at beam qualities $R_{50} < 4 \text{ g cm}^{-2}$ ($E_0 \lesssim 10 \text{ MeV}$). Their use is strongly discouraged, as in general they are responsible for the largest discrepancies in the determinations of absorbed dose in electron beams. Nevertheless, when accurate chamber positioning in water is not possible or when no waterproof chamber is available their use is permitted. The criteria determining the choice of plastic are discussed in Section 4.2.3.

7.8.1. Scaling of depths

Depths in plastic phantoms, z_{pl} , expressed in g cm^{-2} , are obtained by multiplying the depth in cm by the plastic density ρ_{pl} in g cm^{-3} . The density of the plastic, ρ_{pl} , should be measured for the batch of plastic in use rather than using a nominal value for the plastic type. Measurements made in a plastic phantom at depth z_{pl} relate to the depth in water given by

$$z_w = z_{pl} c_{pl} \text{ g cm}^{-2} \quad (z_{pl} \text{ in g cm}^{-2}) \quad (7.9)$$

³² This conversion is required in electron beams because the water-to-air stopping-power ratio $s_{w,air}$ changes rapidly with depth.

³³ Values for $s_{w,air}$ derived from the direct use of this equation by the user must be verified by comparison with the values given in Table 7.V.

where c_{pl} is a depth-scaling factor. Values for c_{pl} for certain plastics are given in Table 7.VI³⁴. Nominal values for the density ρ_{pl} for each plastic are also given in the Table. These are given only for guidance.

TABLE 7.VI. VALUES FOR THE DEPTH-SCALING FACTOR c_{pl} , THE FLUENCE-SCALING FACTOR h_{pl} AND THE NOMINAL DENSITY ρ_{pl} FOR CERTAIN PLASTICS

Plastic phantom	c_{pl}	h_{pl}	$\rho_{pl} (g\ cm^{-3})$
Solid water (WT1)	0.949	1.011	1.020
Solid water (RMI-457)	0.949	1.008 ^a	1.030
Plastic water	0.982	0.998 ^b	1.013
Virtual water	0.946	- ^c	1.030
PMMA	0.941	1.009	1.190
Clear polystyrene	0.922	1.026	1.060
White polystyrene ^d	0.922	1.019	1.060
A-150	0.948	- ^c	1.127

^a Average of the values given in Ref. [95] below 10 MeV.

^b Average of the values given in Ref. [64] below 10 MeV.

^c Data not available.

^d Also referred to as high-impact polystyrene.

7.8.2. Plastic phantoms for beam quality specification

If a plastic phantom is used to measure the beam quality specifier, the measured quantity is the half-value of the depth-ionization distribution in the plastic, $R_{50,ion,pl}$. The $R_{50,ion}$ in water is obtained using Eq. (7.9), i.e.

$$R_{50,ion} = R_{50,ion,pl} c_{pl} \text{ g cm}^{-2} \quad (R_{50,ion,pl} \text{ in g cm}^{-2}) \quad (7.10)$$

The beam quality specifier R_{50} in water is then obtained using Eq. (7.1).

7.8.3. Plastic phantoms for absorbed dose determination at z_{ref}

To determine the absorbed dose to water at z_{ref} in water using a plastic phantom, the chamber must be positioned at the scaled reference depth $z_{ref,pl}$ in the plastic. This is obtained from z_{ref} in water using Eq. (7.9) in inverse form, i.e.

$$z_{ref,pl} = z_{ref} / c_{pl} \text{ g cm}^{-2} \quad (z_{ref} \text{ in g cm}^{-2}) \quad (7.11)$$

All other reference conditions are as in Table 7.II. In addition to depth scaling, the dosimeter reading $M_{Q,pl}$ at depth $z_{ref,pl}$ in the plastic must be scaled to the equivalent reading M_Q at z_{ref} in water using the relation

³⁴ In the present Code of Practice the depths z_w and z_{pl} are defined in units of $g\ cm^{-2}$, in contrast to their definition in cm in TRS-381 [21]. The depth scaling factor, c_{pl} is the ratio of the average depth of electron penetration in water and plastic [93, 94], where these depths are also expressed in $g\ cm^{-2}$. As a result of this change of units, and to a lesser extent the incorporation of new data, the values given for c_{pl} in Table 7.VI differ from those for C_{pl} given in Table VIII of TRS-381. The use of lowercase for c_{pl} denotes the use of these factors only with depths expressed in $g\ cm^{-2}$.

³⁵ Strictly, c_{pl} factors apply only to depth-dose distributions and their use in scaling depth-ionization distributions is an approximation.

$$M_Q = M_{Q,pl} h_{pl} \quad (7.12)$$

Values for the fluence-scaling factor h_{pl} for certain plastics are given in Table 7.VI³⁶. The uncertainty associated with this scaling is the main reason for avoiding the use of plastic phantoms. The absorbed dose to water at z_{ref} in water follows from the value for M_Q given by Eq. (7.12) and the use of Eq. (7.3).

7.8.4. Plastic phantoms for depth-dose distributions

When using a plastic phantom to determine the depth-dose distribution, each measurement depth in plastic must be scaled using Eq. (7.9) to give the appropriate depth in water. The dosimeter reading at each depth must also be scaled using Eq. (7.12). For depths beyond $z_{ref,pl}$ (as given by Eq. (7.11)) it is acceptable to use the value for h_{pl} at $z_{ref,pl}$ derived from Table 7.VI. At shallower depths, this value for h_{pl} should be decreased linearly to a value of unity at zero depth; this ignores the effect of backscatter differences at the surface.

If an ionization chamber is used, the measured depth-ionization distribution must be converted to a depth-dose distribution. This is achieved by multiplying the ionization current or charge at each depth by the appropriate stopping-power ratio $s_{w,air}$, as described in Section 7.7.1.

7.9. Estimated uncertainty in the determination of absorbed dose to water under reference conditions

Uncertainty estimates are presented in two tables; Table 7.VII for determinations of absorbed dose based on a ⁶⁰Co calibration factor and Table 7.VIII for determinations of absorbed dose based on calibration in a high-energy electron beam with $R_{50} \sim 10 \text{ g cm}^{-2}$ ($E_o \sim 23 \text{ MeV}$). In each table, estimates are given for both plane-parallel and cylindrical chamber types (note that R_{50} must be not less than 4 g cm^{-2} when a cylindrical chamber is used). Uncertainty estimates are not given for the determination of absorbed dose at depths other than z_{ref} , although these may be large when plastic phantoms are used. The uncertainty of the k_{Q,Q_o} factors is discussed in Appendix B.

If measured values for k_{Q,Q_o} are used instead of calculated values, the combined uncertainty in the determination of absorbed dose to water may be considerably reduced. For example, if values for k_Q (that is, relative to ⁶⁰Co) are measured for a plane-parallel chamber with a standard uncertainty of around 0.8%, the estimated overall uncertainty in the determination of the absorbed dose to water at z_{ref} in an electron beam is reduced from 2.1% to 1.5%.

The uncertainty in the determination of the absorbed dose to water based on a plane-parallel chamber cross-calibrated in a high-energy electron beam (against a cylindrical chamber having an absorbed dose to water calibration factor in a ⁶⁰Co beam) deserves special attention because cancellations must be taken into account. Combining Eq (7.7) (the use of a cross-calibrated chamber), Eq (7.5) (the cross-calibration factor) and Eq (3.4) (the basic equation for k_Q) the full expression for the absorbed dose to water is

$$D_{w,Q} = M_Q^{pp} \frac{M_{Q_{cross}}^{cyl}}{M_{Q_{cross}}^{pp}} N_{D,w,Co-60}^{cyl} \frac{(s_{w,air})_Q}{(s_{w,air})_{Co-60}} \frac{(W_{air})_Q}{(W_{air})_{Co-60}} \frac{p_Q^{pp}}{p_{Q_{cross}}^{pp}} \frac{P_{Q_{cross}}^{cyl}}{P_{Co-60}^{cyl}} \quad (7.13)$$

³⁶ In TRS-381 [21], values for h_{pl} are given as a function of energy. In the present Code of Practice, plastic phantoms may only be used for $R_{50} < 4 \text{ g cm}^{-2}$ ($E_o \lesssim 10 \text{ MeV}$) and in this energy range the value for h_{pl} for a given plastic can be taken as a constant to an acceptable accuracy.

where for clarity the subscript denoting the reference quality “Co-60” has been explicitly written (instead of Q_o). Note here that the $s_{w,air}$ and W_{air} in Q_{cross} do not appear, because of cancellation. The three chamber readings will be correlated to some extent, and a combined uncertainty of 0.8 % for all three seems reasonable. The uncertainty of $N_{D,w,Co-60}$ is 0.6 %. The ratios of the stopping-power ratios $s_{w,air}$ and W_{air} are each 0.5 % (see Table B.IV). The ratio of perturbation factors p for the plane-parallel chamber in two electron qualities is 0.4 % (the four components of Table B.V). The ratio of perturbation factors p for the cylindrical chamber is 1.0 % (the four components of Table B.IV). Thus a consistent approximate estimate of the combined uncertainty of $D_{w,Q}$ is 1.6 %.

TABLE 7.VII. ESTIMATED RELATIVE STANDARD UNCERTAINTY ^a OF $D_{w,Q}$ AT THE REFERENCE DEPTH IN WATER AND FOR AN ELECTRON BEAM, BASED ON A CHAMBER CALIBRATION IN ⁶⁰Co GAMMA RADIATION

Physical quantity or procedure	Relative standard uncertainty (%)		
	User chamber type: Beam quality range:	cylindrical $R_{50} \geq 4 \text{ g cm}^{-2}$	plane-parallel $R_{50} \geq 1 \text{ g cm}^{-2}$
<i>Step 1: Standards laboratory</i>			
$N_{D,w}$ calibration of secondary standard at PSDL		0.5	0.5
Long-term stability of secondary standard		0.1	0.1
$N_{D,w}$ calibration of user dosimeter at SSDL		0.4	0.4
<i>Combined uncertainty of Step 1</i> ^b		0.6	0.6
<i>Step 2: User electron beam</i>			
Long-term stability of user dosimeter		0.3	0.4
Establishment of reference conditions		0.4	0.6
Dosimeter reading M_Q relative to beam monitor		0.6	0.6
Correction for influence quantities k_i		0.4	0.5
Beam quality correction k_Q (calculated values)		1.2	1.7
<i>Combined uncertainty of Step 2</i>		1.5	2.0
Combined standard uncertainty of $D_{w,Q}$ (Steps 1+2)		1.6	2.1

^a See ISO Guide to the expression of uncertainty [32] or Appendix D. The estimates given in the table should be considered typical values; these may vary depending on the uncertainty quoted by standards laboratories for calibration factors and on the experimental uncertainty at the user institution.

^b A user chamber calibrated directly at a PSDL will have a slightly smaller uncertainty for Step 1. However, this has no significant effect on the combined uncertainty of the determination of absorbed dose to water in the user reference beam.

TABLE 7.VIII. ESTIMATED RELATIVE STANDARD UNCERTAINTY ^a OF $D_{w,Q}$ AT THE REFERENCE DEPTH IN WATER AND FOR AN ELECTRON BEAM, BASED ON A CHAMBER CALIBRATION IN A HIGH-ENERGY ELECTRON BEAM

Physical quantity or procedure	Relative standard uncertainty (%)		
	User chamber type: Beam quality range:	cylindrical $R_{50} \geq 4 \text{ g cm}^{-2}$	plane-parallel $R_{50} \geq 1 \text{ g cm}^{-2}$
<i>Step 1: PSDL</i>			
$N_{D,w}$ calibration of user dosimeter at PSDL		0.7	0.7
<i>Combined uncertainty of Step 1</i>		0.7	0.7
<i>Step 2: User electron beam</i>			
Long-term stability of user dosimeter		0.3	0.4
Establishment of reference conditions		0.4	0.6
Dosimeter reading M_Q relative to beam monitor		0.6	0.6
Correction for influence quantities k_i		0.4	0.5
Beam quality correction k_{Q,Q_0} (calculated values)		0.9	0.6
<i>Combined uncertainty of Step 2</i>		1.3	1.2
Combined standard uncertainty of $D_{w,Q}$ (Steps 1+2)		1.4	1.4

^a See ISO Guide to the expression of uncertainty [32] or Appendix D. The estimates given in the table should be considered typical values; these may vary depending on the uncertainty quoted by standards laboratories for calibration factors and on the experimental uncertainty at the user institution.

7.10. Worksheet

Determination of the absorbed dose to water in an electron beam

User: _____

Date: _____

1. Radiation treatment unit and reference conditions for $D_{w,Q}$ determination

Accelerator: _____ Nominal energy: _____ MeV
 Nominal dose rate: _____ MU min⁻¹ Measured R_{50} : _____ g cm⁻²
 Reference phantom: water plastic obtained from ionization dose curves
 Reference field size: _____ cm x cm Reference SSD: _____ 100 cm
 Beam quality, $Q (R_{50,w})$: _____ g cm⁻² Reference depth $z_{ref,w} = 0.6 R_{50} - 0.1$: _____ g cm⁻²

2. Ionization chamber and electrometer

Ionization chamber model: _____ Serial no.: _____ Type: pp cyl
 Chamber wall / window material: _____ thickness: _____ g cm⁻²
 Waterproof sleeve / cover material: _____ thickness: _____ g cm⁻²
 Phantom window material: _____ thickness: _____ g cm⁻²
Absorbed-dose-to-water calibration factor^a $N_{D,w,Q_0} =$ _____ Gy nC⁻¹ Gy rdg⁻¹
 Calibration quality Q_0 : ⁶⁰Co electron beam Calibration depth: _____ g cm⁻²
 If Q_0 is electron beam, give R_{50} : _____ g cm⁻²
 Reference conditions for calibration P_o : _____ kPa T_o : _____ °C Rel. humidity: _____ %
 Polarizing potential V_j : _____ V Calibration polarity: +ve -ve corrected for polarity effect
 User polarity: +ve -ve
 Calibration laboratory: _____ Date: _____
 Electrometer model: _____ Serial no.: _____
 Calibrated separately from chamber: yes no Range setting: _____
 If yes Calibration laboratory: _____ Date: _____

3. Phantom

Water phantom window material: _____ thickness: _____ g cm⁻²
 Plastic phantom phantom material: _____ density: _____ g cm⁻³
 depth scaling factor c_{pl} : _____ reference depth $z_{ref,pl} = z_{ref} / c_{pl}$: _____ g cm⁻²
 fluence scaling factor^b: $h_{pl} =$ _____

4. Dosimeter reading^c and correction for influence quantities

Uncorrected dosimeter reading at V_j and user polarity: _____ nC rdg
 Corresponding accelerator monitor units: _____ MU
 Ratio of dosimeter reading and monitor units: $M_I =$ _____ nC MU⁻¹ rdg MU⁻¹
 (i) Pressure P : _____ kPa Temperature T : _____ °C Rel. humidity (if known): _____ %

$$k_{TP} = \frac{(273.2 + T) P_o}{(273.2 + T_o) P} =$$

 (ii) Electrometer calibration factor^d k_{elec} : nC rdg⁻¹ dimensionless $k_{elec} =$ _____

(iii) Polarity correction ^e rdg at +V_I: M₊ = _____ rdg at -V_I: M₋ = _____

$$k_{pol} = \frac{|M_+| + |M_-|}{2M} = \underline{\hspace{2cm}}$$

(iv) Recombination correction (two-voltage method)

Polarizing voltages: V₁ (normal) = _____ V V₂ (reduced) = _____ V

Readings ^f at each V: M₁ = _____ M₂ = _____

Voltage ratio V₁ / V₂ = _____

Ratio of readings M₁ / M₂ = _____

Use Table 4.VII for a beam of type: pulsed pulsed-scanned

a₀ = _____ a₁ = _____ a₂ = _____

$$k_s = a_0 + a_1 \left(\frac{M_1}{M_2} \right) + a_2 \left(\frac{M_1}{M_2} \right)^2 = \underline{\hspace{2cm}} \quad \text{g, h}$$

Corrected dosimeter reading at the voltage V_I:

$$M_Q = M_I h_{pl} k_{TP} k_{elec} k_{pol} k_s = \underline{\hspace{2cm}} \quad \text{□ nC MU}^{-1} \quad \text{□ rdg MU}^{-1}$$

5. Absorbed dose to water at the reference depth, z_{ref}

Beam quality correction factor for user quality Q:

If Q_o is ⁶⁰Co Table 7.III gives

$$k_{Q,Q_o} = \underline{\hspace{2cm}}$$

If Q_o is electron beam Table 7.IV gives

$$k_{Q,Q_{int}} = \underline{\hspace{2cm}}$$

$$k_{Q_o,Q_{int}} = \underline{\hspace{2cm}}$$

$$k_{Q,Q_o} = \frac{k_{Q,Q_{int}}}{k_{Q_o,Q_{int}}} = \underline{\hspace{2cm}}$$

If k_{Q,Q_o} derived from series of electron beam calibrations

$$k_{Q,Q_o} = \underline{\hspace{2cm}}$$

Calibration laboratory: _____ Date: _____

$$D_{w,Q}(z_{ref}) = M_Q N_{D,w,Q_o} k_{Q,Q_o} = \underline{\hspace{2cm}} \text{ Gy MU}^{-1}$$

6. Absorbed dose to water at the depth of dose maximum, z_{max}

Depth of dose maximum: z_{max} = _____ g cm⁻²

Percentage depth-dose at z_{ref} for a ___ cm x ___ cm field size: PDD(z_{ref} = _____ g cm⁻²) = _____ %

Absorbed-dose calibration of monitor at z_{max}:

$$D_{w,Q}(z_{max}) = 100 D_{w,Q}(z_{ref}) / PDD(z_{ref}) = \underline{\hspace{2cm}} \text{ Gy MU}^{-1}$$

^a Note that if Q_o is ⁶⁰Co, N_{D,w,Q_o} is denoted by N_{D,w}.

^b If a water phantom is used set the fluence scaling factor h_{pl} = 1

^c All readings should be checked for leakage and corrected if necessary

^d If the electrometer is not calibrated separately set k_{elec} = 1

^e M in the denominator of k_{pol} denotes reading at the user polarity. Preferably, each reading in the equation should be the average of the ratios of M (or M₊ or M₋) to the reading of an external monitor, M_{em}.

It is assumed that the calibration laboratory has performed a polarity correction. Otherwise k_{pol} is determined according to

rdg at +V_I for quality Q_o: M₊ = _____ rdg at -V_I for quality Q_o: M₋ = _____

$$k_{pol} = \frac{[(M_+ + |M_-|)/|M|]_Q}{[(M_+ + |M_-|)/|M|]_{Q_o}} = \underline{\hspace{2cm}}$$

^f Strictly, readings should be corrected for polarity effect (average with both polarities). Preferably, each reading in the equation should be the average of the ratios of M₁ or M₂ to the reading of an external monitor, M_{em}.

^g Check that $k_s - 1 \approx \frac{M_1/M_2 - 1}{V_1/V_2 - 1}$

^h It is assumed that the calibration laboratory has performed a recombination correction. Otherwise the factor $k'_s = k_s/k_{s,Q_o}$ should be used instead of k_s . When Q_o is ^{60}Co , k_{s,Q_o} (at the calibration laboratory) will normally be close to unity and the effect of not using this equation will be negligible in most cases.

8. CODE OF PRACTICE FOR LOW-ENERGY KILOVOLTAGE X-RAY BEAMS

8.1. General

This Section provides a Code of Practice for reference dosimetry (beam calibration) and recommendations for relative dosimetry in x-ray beams with half-value layers of up to 3 mm of aluminium and generating potentials of up to 100 kV. It is based upon a calibration factor in terms of absorbed dose to water N_{D,w,Q_0} for a dosimeter in a reference beam of quality Q_0 .

This range of beam qualities is referred to here as the low-energy x-ray range. The division into low- and medium-energy ranges (the latter presented in Section 9) is intended to reflect the two distinct types of radiation therapy for which kilovoltage x-rays are used, ‘superficial’ and ‘deep’ (‘orthovoltage’). The boundary between the two ranges defined in this section and the next is not strict and has an overlap between 80 kV, 2 mm Al and 100 kV, 3 mm Al. In the overlap region the methods of either section are equally satisfactory and whichever is more convenient should be used.

There is a limited availability of standards of absorbed dose to water in the kilovoltage x-ray range. However it is possible to derive calibration factors in terms of absorbed dose to water from air-kerma calibration factors using one of the accepted Codes of Practice (see Appendix A.2). Thus any calibration laboratory with standards of air kerma can in this way provide derived calibrations in terms of absorbed dose to water. Even though this is formally equivalent to the user obtaining an air-kerma calibration and individually applying the same air-kerma Code of Practice, it has the advantage of permitting the widespread use of the unified methodology presented here, in a field of dosimetry where standard methods are notably lacking.

The dosimetry of low-energy x-rays has traditionally been based on measurements in air of exposure or air kerma. The absorbed dose at the surface of water is derived from this measurement by converting exposure or air kerma to absorbed dose to water and applying a correction factor for the effect of backscatter. This is still the basis of most current dosimetry Codes of Practice for low-energy x-rays [17, 96, 97]. The IAEA Code of Practice TRS-277 [17] also includes the option of basing the dosimetry on measurements made in a full scatter phantom, using a chamber that has been calibrated directly in terms of absorbed dose to water while mounted in the phantom. This is the approach taken in the present Code of Practice, expressed in terms of the formalism given in Section 3.

8.2. Dosimetry equipment

8.2.1. Ionization chambers

The recommendations regarding ionization chambers given in Section 4.2.1 should be followed. The chamber should be of a type designed for use with low-energy x-rays, as given in Table 4.III. The chamber window thickness should be sufficient to allow full build-up of the secondary electron spectrum. This will also prevent secondary electrons generated upstream from entering the chamber. If the chamber is to be used with x-rays 50 kV or above it will usually be necessary to add foils of similar material to the chamber window to ensure full build-up. The total thickness required (including the thickness of the chamber wall) is given for various plastics in Table 8.I. If the exact thickness in the Table can not be matched, then a slightly thicker foil should be used, because while the attenuation of the x-rays from the additional thickness is negligible, full build-up will be assured.

The reference point of the chamber for the purpose of calibration at the standards laboratory and for measurements under reference conditions in the user beam is taken to be on the outside of the chamber window at the window centre (or the outside of the build-up foil if this is used). This point is positioned so that it is flush with the front surface of the phantom. The chamber and phantom and any build-up foils should be calibrated together at the standards laboratory at the same SSD and field size

used for reference dosimetry in the clinic. Because of large chamber-to-chamber variations in energy response it is not recommended that a generic set of k_{Q,Q_0} values for a particular type of chamber be used.

TABLE 8.I. TOTAL THICKNESS ^a OF MATERIAL REQUIRED FOR FULL BUILD-UP

kV	Polyethylene		PMMA ^b		Mylar	
	mg cm ⁻²	μm	mg cm ⁻²	μm	mg cm ⁻²	μm
50	4.0	45	4.4	40	4.6	35
60	5.5	60	6.1	50	6.4	45
70	7.2	80	8.0	65	8.3	60
80	9.1	100	10.0	85	10.5	75
90	11.1	120	12.2	105	12.9	90
100	13.4	140	14.7	125	15.4	110

^a The thickness specified is taken to be equal to the csda range of the maximum energy secondary electrons, as given in ICRU Report 37 [66].

^b Polymethyl Methacrylate, also known as acrylic. Trade names are *Lucite*, *Plexiglas* or *Perspex*.

8.2.2. Phantoms

The recommendations regarding phantoms given in Sections 4.2.3 and 4.2.4 should be followed. The phantom must permit the chamber to be mounted with the outside face of the chamber window flush with the phantom surface. This is normally not possible using a water phantom and so a plastic phantom should be used. The use of a water-equivalent material designed for use in kilovoltage x-rays is ideal but PMMA (perspex, Lucite, etc.) is acceptable ³⁷. Because the phantom/chamber unit is calibrated in terms of absorbed dose to water at the surface, no dose or depth conversions are needed, irrespective of the type of plastic used. The phantom should extend in the beam direction by at least 5 g cm⁻² and in the lateral direction at least far enough beyond the reference field size used to ensure that the entire primary beam exits through the rear face of the phantom.

8.3. Beam quality specification

8.3.1. Choice of beam quality index

It has long been known that it is desirable to use more than one beam quality parameter to characterize a kilovoltage x-ray spectrum for dosimetry ([98] [99]). The usual quantities used are the kilovoltage generating potential (kV) and the half-value layer (HVL). However, it is often not possible to match both the kV and HVL of each clinical beam with the beams of the standards laboratory. Therefore the primary beam quality index has traditionally been the HVL. This is the beam quality index used in this Code of practice for low-energy x-rays.

In spite of the fact that previous dosimetry protocols for kV x-rays have used HVL only as the quality index, these protocols have not included any discussion on the uncertainty arising from this choice. This is a component of uncertainty which should not be overlooked. Unfortunately, there is insufficient published experimental work to indicate how calibration factors in terms of absorbed dose

³⁷ PMMA is acceptable for a phantom that is used only for measurements at the surface. This is because the phantom needs reproduce only the backscatter, and not the attenuation or scatter at depth. The chamber is calibrated in the phantom under the reference conditions of field size and SSD, and so as long as these are similar to the reference conditions in the clinic, any difference between PMMA and water will be very small. For the measurement of output factors at other field sizes and SSDs, it is only the ratio of the backscatter at the different geometries which must be similar to that of water. Even though PMMA is not water-equivalent, the backscatter is typically an order of magnitude less than the absorbed dose at the surface, and the difference in backscatter between water and PMMA is another order of magnitude less again. So the overall disagreement is typically no more than 1%.

to water will vary independently with HVL and kV. Some indication may be gained from the air-kerma calibration factor $N_{K,Q}$ for a PTW M23342 chamber over the range of typical beams used for therapy (see Fig. 8.1). For a given HVL the calibration factor varies over a range of up to a little over 2 %. However this is not truly indicative of the variation of $N_{D,w}$ because it does not take account of the response of the chamber to scatter from the phantom, or the factor to convert from air kerma to dose to water. One can only conjecture that the variation in $N_{D,w,Q}$ will be similar to that of $N_{K,Q}$. A conservative figure of 1.5 % is taken as the Type B standard uncertainty (See Section D.3) for the types of chamber recommended in this Code of Practice.

It should be noted that the concept of HVL is based on the response of a dosimeter to air kerma. The development of a new quality index for kV x-rays based on the quantity absorbed dose to water (possibly a ratio of doses at different depths) that can be adopted by future versions of this Code of Practice would be welcomed.

It is of course preferable, where possible, to have the dosimeter calibrated at the same combinations of kV and HVL as those of the user clinical beams. But if this is not possible, calibration data should be obtained for beams with lesser and greater HVLs and the desired values derived by interpolation (see Worksheet).

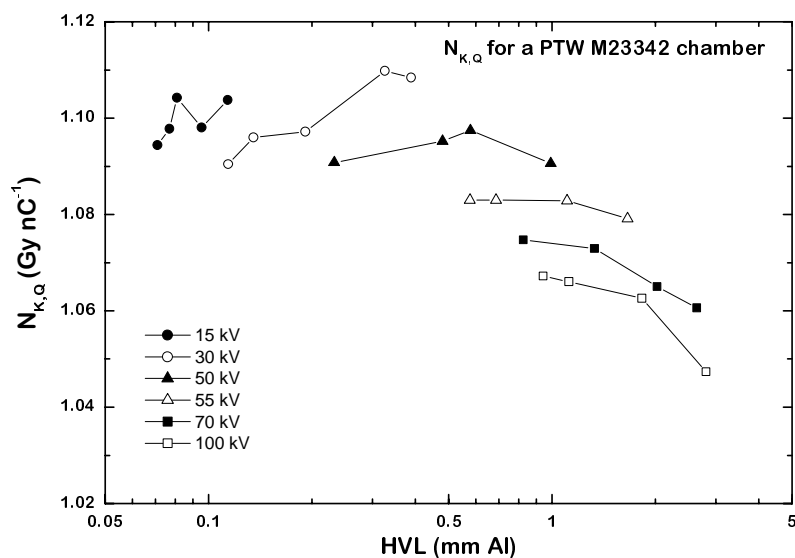

Fig. 8.1. Air-kerma calibration factors for a PTW M23342 chamber as a function of generating potential and HVL in the range 15 kV to 100 kV. Data measured at NRL.

8.3.2. Measurement of beam quality

The conventional material used for the determination of the HVL in low-energy x-ray beams is aluminium. The HVL is defined as the thickness of an absorber which reduces the air-kerma rate of a narrow x-ray beam at a reference point distant from the absorbing layer to 50% compared with air-kerma rate for the non-attenuated beam.

Because of the absorption of low-energy x-rays in air, the HVL varies with the distance from the x-ray target. Therefore the HVL for low-energy x-ray beams should, as far as possible, be measured with the chamber at the same SCD as will be used for measurements of absorbed dose. If the distance from the target to the chamber is less than 50 cm, scatter from the added filters may affect the result. This can be checked by using different field sizes and extrapolating to zero field size if necessary.

The ideal arrangement is to place at about half the distance between the x-ray target and the chamber a collimating aperture that reduces the field size to just enough to encompass the whole of the chamber. There should be no other scattering material in the beam up to 1 metre behind the chamber. The filters added for the HVL measurement are placed close to the aperture in combinations of thickness which span the HVL thickness to be determined. The thickness that reduces the air-kerma rate to one half is obtained by interpolation.

Strictly, it is the ionization current or integrated charge per exposure time that is measured, not the air-kerma rate. This distinction is particularly relevant for lightly-filtered beams. A thin-walled chamber with an energy response that varies less than 2% over the quality range measured should be used³⁸. If required, build-up foil should be added to the chamber window as described in Section 8.2.1.

A monitor chamber should be used to prevent misleading results due to the variation in x-ray output. Care must be taken so that the response of the monitor chamber is not affected by increasing scatter as more filters are placed in the beam. If a monitor chamber is not available, the effects of output variation can be minimized by randomizing the measurement sequence and measuring the air-kerma rate without additional filters both at the beginning and at the end.

The purity of aluminium used for HVL measurements should be 99.9%. For further guidance on HVL determination see ICRU Report 10b [98], TRS-110 [71], TRS-374 [33] or Ref. [100].

8.4. Determination of absorbed dose to water

8.4.1. Reference conditions

The reference conditions for the determination of absorbed dose to water are given in Table 8.II.

TABLE 8.II. REFERENCE CONDITIONS FOR THE DETERMINATION OF ABSORBED DOSE IN LOW-ENERGY X-RAY BEAMS

Influence quantity	Reference value or reference characteristics
Phantom material	water-equivalent plastic or PMMA
Chamber type	plane-parallel for low-energy x-rays
Measurement depth z_{ref}	phantom surface
Reference point of the chamber	at the centre of outside surface of chamber window or additional build-up foil if used ^a
SSD	usual treatment distance as determined by the reference applicator ^b
Field size	3 cm x 3 cm, or 3 cm diameter, or as determined by the reference applicator ^b

^a The reference point of the chamber is the outside surface because the calibration factor $N_{D,w,Q}$ is given in terms of the absorbed dose to the surface of water.

^b An applicator with a field size equal to (or otherwise minimally larger than) the reference field size should be chosen as the reference applicator.

³⁸ HVL measurement errors of up to 10% can result using a Farmer-type chamber in a lightly-filtered 100 kV beam. If the chamber energy response varies by more than 2% over the quality range, then each measurement must be converted to an air kerma measurement using an air-kerma calibration factor appropriate for each filtered or unfiltered beam. This is an iterative process because the calibration factor itself is determined by the HVL.

8.4.2. Determination of absorbed dose under reference conditions

The general formalism is given in Section 3. The absorbed dose to water at the water surface, in a low-energy x-ray beam of quality Q and in the absence of the chamber, is given by

$$D_{w,Q} = M_Q N_{D,w,Q_0} k_{Q,Q_0} \quad (8.1)$$

where M_Q is the reading of the dosimeter with the reference point of the chamber positioned at z_{ref} in accordance with the reference conditions given in Section 8.4.1 and corrected for the influence quantities temperature and pressure, and electrometer calibration, as described in the Worksheet (see also Section 4.4.3). Note that the polarity and ion recombination corrections are difficult to measure on the type of chamber recommended for low-energy x-rays due to electrostatic distortion of the chamber window. However, the effects will be negligible as long as the polarity is kept the same as was used for calibration and the absorbed-dose rate is less than a few grays per second (see Ref. [101]). N_{D,w,Q_0} is the calibration factor in terms of absorbed dose to water for the dosimeter at the reference quality Q_0 and k_{Q,Q_0} is a chamber-specific factor which corrects for differences between the reference beam quality Q_0 and the actual beam quality being used Q . Note also that the correction for timer error may be significant. It is not a multiplicative correction, and is therefore treated separately in the Worksheet.

8.5. Values for k_{Q,Q_0}

It is not possible to calculate values of k_{Q,Q_0} using Bragg-Gray theory because a thin-walled chamber on the surface of a phantom does not represent a Bragg-Gray cavity. Therefore the values for k_{Q,Q_0} must be obtained directly from measurements. Generic values, measured for a particular chamber type, should not be used because of large chamber-to-chamber variations in energy response.

The calibration data for the dosimeter should ideally be presented as a single calibration factor N_{D,w,Q_0} determined in a reference beam of quality Q_0 and one or more measured factors k_{Q,Q_0} corresponding to the other calibration qualities Q . However, if the calibration data are in the form of a set of calibration factors $N_{D,w,Q}$ then one of the qualities should be chosen as the reference beam quality Q_0 ³⁹. The corresponding calibration factor becomes N_{D,w,Q_0} and the other calibration factors $N_{D,w,Q}$ are expressed in terms of k_{Q,Q_0} using the relation:

$$k_{Q,Q_0} = \frac{N_{D,w,Q}}{N_{D,w,Q_0}} \quad (8.2)$$

If the quality of the user beam does not match any of the calibration qualities, the value for k_{Q,Q_0} to be used in Eq. (8.1) can be interpolated (see Worksheet).

A chamber calibrated in a series of beam qualities may be subsequently re-calibrated at only the reference quality Q_0 . In this case the new value for N_{D,w,Q_0} should be used with the values of k_{Q,Q_0} previously measured. However, because of the particular susceptibility of ionization chambers to change in energy response to low-energy x-rays, it is preferable that chambers are re-calibrated at all qualities each time. In particular, if N_{D,w,Q_0} changes by an amount more than the uncertainty stated for the calibration, or there have been any repairs to the chamber, then the dosimeter should be re-calibrated at all qualities.

³⁹ The choice here is not critical; the quality corresponding to the $N_{D,w,Q}$ factor with the smallest uncertainty is appropriate, otherwise a quality close to the middle of the range.

8.6. Measurements under non-reference conditions

8.6.1. Central axis depth-dose distributions

An estimate of depth dose distributions may be obtained from the literature [81]. However if desired, the depth-dose distribution can be measured by using the same chamber as that used for reference dosimetry and a water-equivalent phantom.

Thin sheets of water-equivalent phantom material designed for use with kilovoltage x-rays are placed over the chamber in its phantom and the phantom is moved back by the same amount to maintain a constant SSD. The manufacturer's specifications for the material should state that it is equivalent to water within a few percent in the energy range of interest. This should be verified by comparison with published data. PMMA is not suitable for measurement of depth-dose distributions, even if it is used as the phantom material for reference dosimetry. Strictly, this procedure provides a depth-ionization distribution rather than the depth-dose distribution. However, if the response of the chamber is reasonably constant (within 5%) with beam quality, the error introduced by assuming that the depth-dose distribution is the same as the depth-ionization distribution is not likely to be more than a few percent at any clinically relevant depth.

8.6.2. Output factors

For clinical applications, output factors are required for all combinations of SSD and field size used for radiotherapy treatments. The output factor is the ratio of the corrected dosimeter reading at the surface for a given set of non-reference conditions to that for the reference conditions (reference conditions are given in Table 8.II).

Because of the significant scatter contribution from the inside of an applicator, it is not sufficiently accurate to estimate output factors for different applicators using the ratio of the backscatter factors corresponding to the respective field sizes. The output factor must be measured for each beam quality and each individual applicator.

If a PMMA phantom is used, the response of the chamber to different field sizes will not be exactly the same as that for a water phantom, due to the difference in back-scatter (see footnote in Section 8.2.2). However, because the output factor is a ratio of measurements, this effect should not incur an error of greater than 1%, particularly if the reference field size is in the middle of the range of sizes used clinically.

8.7. Estimated uncertainty in the determination of absorbed dose to water under reference conditions

There is to date very little practical experience in primary standards of absorbed dose for low-energy x-rays. The uncertainty in $N_{D,w,Q}$ determined directly from a primary standard is assumed here to be 1%. Alternatively, if the calibration factor in terms of absorbed dose to water is derived from a standard of air kerma, the uncertainty in the determination of $N_{D,w,Q}$ is estimated as 3%. In the latter case, the uncertainty of $N_{D,w,Q}$ then dominates the overall uncertainty.

The stability of a good dosimeter over a series of readings is typically better than 0.1%, but the temperature of the chamber may be uncertain to at least $\pm 1^\circ\text{C}$ because of heating from the x-ray tube. The x-ray output from some machines depends on line voltage, tube temperature, and operator control of tube current and voltage. This variation is minimized when the exposures are controlled by a monitor chamber, but this is rarely the case on dedicated low-energy x-ray machines where the variation in output over a series of identical exposure times may be as much as 5%. This uncertainty should be separately estimated by the user from the standard deviation of a set of at least five exposures of typical treatment length. It is not included in this analysis.

Because the SSD is often very short on a low-energy x-ray machine, there may be difficulty in achieving a positioning reproducibility that results in an uncertainty in the determination of absorbed dose to water better than 1%, so this uncertainty is assigned to establishment of reference conditions.

For low-energy x-ray dosimetry, the values for k_{Q,Q_0} are derived directly from the calibration factors $N_{D,w,Q}$. If the value of N_{D,w,Q_0} used in Eq. (8.1) is the same as that used in Eq. (8.2), then the uncertainty in the product $k_{Q,Q_0} N_{D,w,Q_0}$ is just the uncertainty in $N_{D,w,Q}$ together with an additional 1.5% to account for the uncertainty of matching the calibration and user beams on the basis of HVL. However, if the N_{D,w,Q_0} used in Eq. (8.1) is different because it has been obtained from a subsequent calibration of the dosimeter, then the uncertainty in k_{Q,Q_0} is increased because of the lack of correlation between the new N_{D,w,Q_0} and that used to calculate the k_{Q,Q_0} . This results in an increase in the combined standard uncertainty of $D_{w,Q}$ of about 0.2%.

The uncertainties are summarized in Table 8.III.

TABLE 8.III. ESTIMATED RELATIVE STANDARD UNCERTAINTY ^a OF $D_{w,Q}$ AT THE REFERENCE DEPTH IN WATER FOR A LOW-ENERGY X-RAY BEAM

Physical quantity or procedure	Relative standard uncertainty (%)			
	<i>SSDL</i>	<i>SSDL</i>	<i>PSDL</i>	<i>PSDL</i>
<i>Step 1: Standards Laboratory</i>				
N_{D,w,Q_0} or N_K calibration of secondary standard at PSDL	1.0	0.5		
Long term stability of secondary standard	0.1	0.1		
N_{D,w,Q_0} calibration of the user dosimeter at the standards lab				
Absorbed-dose standard	0.5		1.0	
Derived from air-kerma standard		3.0		3.0
<i>Combined uncertainty in Step 1</i>	<i>1.2</i>	<i>3.0</i>	<i>1.0</i>	<i>3.0</i>
<i>Step 2: User x-ray beam</i>				
Long-term stability of user dosimeter			0.3	
Establishment of reference conditions			1.0	
Dosimeter reading M_Q relative to timer or beam monitor			0.1	
Correction for influence quantities k_i			0.8	
Beam quality correction, k_{Q,Q_0}			1.5	
<i>Combined uncertainty in Step 2:</i>			<i>2.0</i>	
Combined standard uncertainty of $D_{w,Q}$ (Steps 1 + 2)	2.3	3.6	2.2	3.6

^a See ISO Guide to the expression of uncertainty [32] or Appendix D. The estimates given in the table should be considered typical values; these may vary depending on the uncertainty quoted by standards laboratories for calibration factors and on the experimental uncertainty at the user institution.

8.8. Worksheet

Determination of the absorbed dose to water in a low-energy x-ray beam

User: _____ Date: _____

1. Radiation treatment unit and reference conditions for $D_{w,Q}$ determination

x-ray machine: _____ Nominal tube potential: _____ kV
Nominal tube current: _____ mA Beam quality, Q (HVL): _____ mm Al
Reference phantom: _____ Reference depth: phantom surface
Added foil material: _____ Thickness: _____ mm
Reference field size: _____ cm x cm Reference SSD: _____ cm

2. Ionization chamber and electrometer

Ionization chamber model: _____ Serial no.: _____

Chamber wall material: _____ thickness = _____ g cm⁻²

Absorbed-dose-to-water calibration factor $N_{D,w,Q_0} =$ _____ Gy nC⁻¹ Gy rdg⁻¹

Reference beam quality, Q_0 (HVL): _____ mm Al

Reference conditions for calibration P_0 : _____ kPa T_0 : _____ °C Rel. humidity: _____%

Polarizing potential V : _____ V Calibration polarity: +ve -ve corrected for polarity effect

User polarity: +ve -ve

Calibration laboratory: _____ Date: _____

Electrometer model: _____ Serial no.: _____

Calibrated separately from chamber: yes no Range setting: _____

If yes Calibration laboratory: _____ Date: _____

3. Dosimeter reading^a and correction for influence quantities

Uncorrected dosimeter reading at V and user polarity: _____ nC rdg

Corresponding time: _____ min

Ratio of dosimeter reading and time^b: $M =$ _____ nC min⁻¹ rdg min⁻¹

(i) Pressure P : _____ kPa Temperature T : _____ °C Rel. humidity (if known): _____%

$$k_{TP} = \frac{(273.2 + T) P_0}{(273.2 + T_0) P} = \underline{\hspace{2cm}}$$

(ii) Electrometer calibration factor^c k_{elec} : nC rdg⁻¹ dimensionless $k_{elec} = \underline{\hspace{2cm}}$

Corrected dosimeter reading at the voltage V :

$$M_Q = M k_{TP} k_{elec} = \underline{\hspace{2cm}} \quad \text{or} \quad \text{_____} \quad \text{or} \quad \text{_____}$$

4. Absorbed dose rate to water at the phantom surface

Beam quality correction factor for user quality Q : $k_{Q,Q_0} = \underline{\hspace{2cm}}$

at Q_0 (HVL) = _____ mm Al

Calibration laboratory: _____ Date: _____

or Beam quality correction factor interpolated:

$$(k_{Q,Q_0})_1 = \text{_____} \text{ at HVL}_1 = \text{_____} \text{ mm Al} \quad \text{Date: _____}$$

$$(k_{Q,Q_0})_2 = \text{_____} \text{ at HVL}_2 = \text{_____} \text{ mm Al} \quad \text{Date: _____}$$

$$k_{Q,Q_0} = (k_{Q,Q_0})_1 + [(k_{Q,Q_0})_2 - (k_{Q,Q_0})_1] \left[\frac{\ln \text{HVL} - \ln \text{HVL}_1}{\ln \text{HVL}_2 - \ln \text{HVL}_1} \right] = \text{_____}$$

Absorbed-dose rate calibration at the phantom surface:

$$D_{w,Q}(\text{surface}) = M_Q N_{D,w,Q_0} k_{Q,Q_0} = \text{_____} \text{ Gy min}^{-1}$$

^a All readings should be checked for leakage and corrected if necessary

^b The timer error should be taken into account. The correction at voltage V can be determined according to

$$M_A \text{ is the integrated reading in a time } t_A \quad M_A = \text{_____} \quad t_A = \text{_____} \text{ min}$$

$$M_B \text{ is the integrated reading in } n \text{ short exposures of time } t_B/n \text{ each } (2 \leq n \leq 5) \quad M_B = \text{_____} \quad t_B = \text{_____} \text{ min} \quad n = \text{_____}$$

$$\text{Timer error, } \tau = \frac{M_B t_A - M_A t_B}{n M_A - M_B} = \text{_____} \text{ min (the sign of } \tau \text{ must be taken into account)}$$

$$M = \frac{M_A}{t_A + \tau} = \text{_____} \quad \square \text{ nC min}^{-1} \quad \square \text{ rdg min}^{-1}$$

^c If the electrometer is not calibrated separately set $k_{elec} = 1$

9. CODE OF PRACTICE FOR MEDIUM-ENERGY KILOVOLTAGE X-RAY BEAMS

9.1. General

This Section provides a Code of Practice for reference dosimetry (beam calibration) and recommendations for relative dosimetry in x-ray beams with half-value layers (HVL) greater than 2 mm of aluminium and generating potentials higher than 80 kV. It is based upon a calibration factor in terms of absorbed dose to water N_{D,w,Q_0} for a dosimeter in a reference beam of quality Q_0 .

This range of beam qualities is referred to here as the medium-energy x-ray range. The division into low- and medium-energy ranges (the former presented in Section 8) is intended to reflect the two distinct types of radiation therapy for which kilovoltage x-rays are used, ‘superficial’ and ‘deep’ (‘orthovoltage’). The boundary between the two ranges defined in this and the previous section is not strict and has an overlap between 80 kV, 2 mm Al and 100 kV, 3 mm Al. In the overlap region the methods of either section are equally satisfactory and whichever is more convenient should be used.

There is a limited availability of standards of absorbed dose to water in the kilovoltage x-ray range. However it is possible to derive calibration factors in terms of absorbed dose to water from air-kerma calibration factors using one of the accepted Codes of Practice (see Appendix A.2). Thus any calibration laboratory with standards of air kerma can in this way provide derived calibration factors in terms of absorbed dose to water. Even though this is formally equivalent to the user obtaining an air-kerma calibration and individually applying the same air-kerma Code of Practice, it has the advantage of permitting the widespread use of the unified methodology presented here, in a field of dosimetry where standard methods are notably lacking.

Most Codes of Practice for the dosimetry of kilovoltage x-rays specify that, for at least part of the energy range, dosimetry is based on the measurement of air kerma free in air. The absorbed dose at the surface of a water phantom is then derived by converting air kerma to absorbed dose to water and by the use of Monte Carlo calculated backscatter factors [17, 96, 97]. In the present Code of Practice because absorbed dose is measured directly, all measurements are done in a water phantom.

Medium-energy x-rays are used today to deliver a therapeutic dose in the depth range of a few millimetres to a few centimetres in tissue. This is in contrast to the early use of this modality of radiation therapy, when treatments were often much deeper. Consequently the traditional reference depth for measurement of 5 g cm^{-2} in water is reduced in this Code of Practice to 2 g cm^{-2} .

9.2. Dosimetry equipment

9.2.1. Ionization chambers

The recommendations regarding ionization chambers given in Section 4.2.1 should be followed. Only cylindrical ionization chambers with a cavity volume in the range $0.1 - 1.0 \text{ cm}^3$ are recommended for reference dosimetry in medium-energy x-ray beams.

The reference point of a cylindrical chamber for the purpose of calibration at the standards laboratory and for measurements under reference conditions in the user beam is taken to be on the chamber axis at the centre of the cavity volume. This point is positioned at a reference depth of 2 g cm^{-2} in the water phantom.

Within a given chamber type, chamber-to-chamber variations in energy response can be significant and, as for low-energy x-rays, each individual dosimeter should be calibrated at a range of beam qualities suitable to allow interpolation to the clinical beam qualities (see Fig 9.1). It is not recommended that a

generic set of k_{Q,Q_0} values for a particular type of chamber be used. The chamber should be calibrated at the same SSD and field size as will be used for reference dosimetry in the clinic.

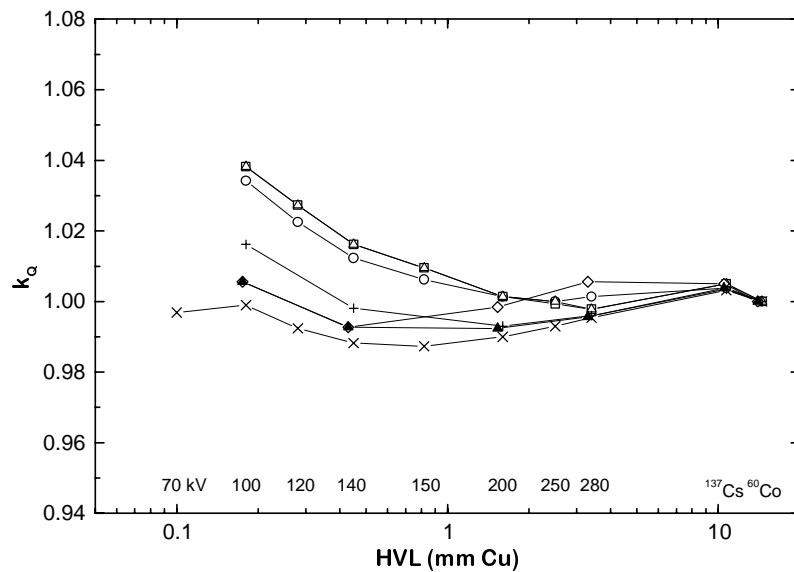

Fig. 9.1. Chamber to chamber variation in k_Q for seven ionization chambers, all of the type M23331. The values are normalized at ^{60}Co . Data measured at PTB.

9.2.2. Phantoms and chamber sleeves

The recommendations regarding phantoms and chamber sleeves given in Sections 4.2.3 and 4.2.4 should be followed. Water is recommended as the reference medium for measurements of absorbed dose with medium-energy x-ray beams. The phantom should extend to at least 5 cm beyond all four sides of the largest field size employed at the depth of measurement. There should also be a margin of at least 10 g cm^{-2} beyond the maximum depth of measurement.

In horizontal beams, the window of the phantom should be made of plastic and of thickness t_{win} between 0.2 cm and 0.5 cm. The water-equivalent thickness (in g cm^{-2}) of the phantom window should be taken into account when evaluating the depth at which the chamber is to be positioned; the thickness is calculated as the product $t_{win} \rho_{pl}$ where ρ_{pl} is the mass density of the plastic (in g cm^{-3}). For commonly used plastics PMMA and clear polystyrene, the nominal values $\rho_{PMMA} = 1.19 \text{ g cm}^{-3}$ and $\rho_{polystyrene} = 1.06 \text{ g cm}^{-3}$ [66] may be used for the calculation of the water-equivalent thickness of the window.

For non-waterproof chambers a waterproofing sleeve should be used, made of PMMA, and preferably not thicker than 1.0 mm. The air gap between the chamber wall and the waterproofing sleeve should be sufficient (0.1 mm to 0.3 mm) to allow the air pressure in the chamber to equilibrate. The same waterproofing sleeve that was used for calibration of the user's ionization chamber should also be used for reference dosimetry. If it is not possible to use the same waterproofing sleeve that was used during calibration at the standardizing laboratory, then another sleeve of the same material and of similar thickness should be used.

9.3. Beam quality specification

9.3.1. Choice of beam quality index

It has long been known that it is desirable to use more than one beam quality parameter to characterize a kilovoltage x-ray spectrum for dosimetry ([98] [99]). The usual quantities used are the kilovoltage generating potential (kV) and the half-value layer (HVL). However, it is often not possible to match both the kV and HVL of each clinical beam with the beams of the standards laboratory. Therefore the primary beam quality index has traditionally been the HVL and this is the beam quality index used in this Code of Practice⁴⁰.

Up until now there are insufficient experimental data available to know how N_{D,w,Q_0} for a medium-energy x-ray chamber varies independently with HVL and generating potential. However, some indication can be gained from Fig. 9.2 which shows a plot of $N_{D,w,Q}$ for an NE2571 chamber as a function of HVL and kV for a range of typical therapy beam qualities. These values have been obtained from $N_{K,Q}$ (air-kerma calibration factor) data using conversion factors given by Seuntjens [99]. The data suggest that the variation in $N_{D,w,Q}$ arising from using HVL only as the beam quality index could be of the order of 1%. A conservative figure of 1.0% is therefore taken as the resulting Type B standard uncertainty. (See Section D.3).

It is of course preferable, where possible, to have the dosimeter calibrated at the same combinations of kV and HVL as those of the user clinical beams. But if this is not possible, calibration data should be obtained for beams with lesser and greater HVLs and the desired values derived by interpolation (see Worksheet).

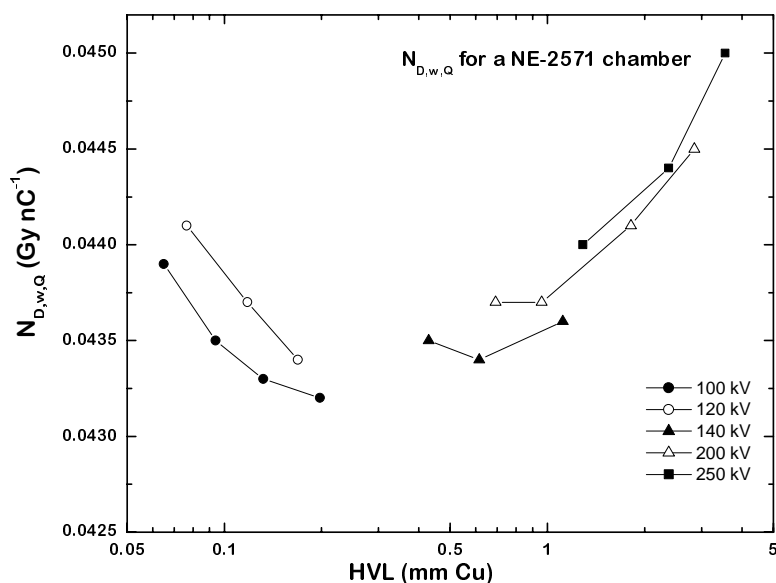

Fig. 9.2. Calibration factor in terms of absorbed dose to water for a NE 2571 chamber as a function of kV and HVL. These are derived from air-kerma calibration factors measured at NRL and converted to absorbed dose using factors given in Ref. [99].

⁴⁰ Other beam quality specifiers were proposed by ICRU in their early Report 10b [98, 99], including a two-point specification in terms of the so-called “fall-off” ratio. A recent proposal for using the ratio of absorbed doses at 2 cm and 5 cm depths in water [102] is promising but needs further investigation. This ratio is likely to be related to the mean x-ray energy at the measurement depth in the phantom which is potentially a better beam quality specifier than the HVL, which is measured in air. As noted in Section 8 the HVL is based on air-kerma measurements and requires a knowledge of the response of the dosimeter to air kerma. The development of a new quality index for kV x-rays based on the quantity absorbed dose to water, that is more appropriate for this Code of Practice, would be welcomed.

9.3.2. Measurement of beam quality

In medium-energy x-ray beams, both aluminium and copper are used to determine the HVL. The HVL is defined as the thickness of an absorber which reduces the air-kerma rate of a narrow x-ray beam at a reference point distant from the absorbing layer to 50% compared with the air-kerma rate for a non-attenuated beam.

The ideal arrangement is to place at about half the distance between the x-ray target and the chamber a collimating aperture that reduces the field size to just enough to encompass the whole of the chamber. There should be no other scattering material in the beam up to 1 metre behind the chamber. The filters added for the HVL measurement are placed close to the aperture in combinations of thickness which span the HVL thickness to be determined. The thickness that reduces the air-kerma rate to one half is obtained by interpolation.

Strictly, it is the ionization current or the integrated charge per exposure time that is measured, not the air-kerma rate. This distinction is particularly relevant for lightly-filtered beams. A chamber with an energy response that varies less than 2% over the quality range measured should be used ⁴¹.

A monitor chamber should be used to prevent misleading results due to the variation in x-ray output. Care must be taken so that the response of the monitor chamber is not affected by increasing scatter as more filters are placed in the path of the beam. If a monitor chamber is not available, the effects of output variation can be minimized by randomizing the measurement sequence and measuring the air-kerma rate without additional filters both at the beginning and at the end.

The purity of aluminium or copper used for HVL measurements should be 99.9%. For further guidance on HVL determination see ICRU Report 10b [98], TRS-110 [71], TRS-374 [33], or Ref. [100].

9.4. Determination of absorbed dose to water

9.4.1. Reference conditions

The reference conditions for the determination of absorbed dose to water are given in Table 9.I.

TABLE 9.I. REFERENCE CONDITIONS FOR THE DETERMINATION OF ABSORBED DOSE IN MEDIUM-ENERGY X-RAY BEAMS

Influence quantity	Reference value or reference characteristics
Phantom material	water
Chamber type	cylindrical
Measurement depth z_{ref} ^a	2 g cm ⁻²
Reference point of chamber	on the central axis at the centre of the cavity volume
Position of reference point of chamber	at the measurement depth z_{ref}
SSD	usual treatment distance ^b
Field size	10 cm x 10 cm, or as determined by a reference applicator ^c

^a z_{ref} is the reference depth in the phantom at which the reference point (see Section 9.2.1) of the chamber is positioned

^b If applicators of different SSD are used, then the one with the greatest SSD should be chosen as the reference applicator.

^c When the x-ray machine has an adjustable rectangular collimator, a 10 cm x 10 cm field should be set. Otherwise, if the field is defined by fixed applicators, a reference applicator of comparable size should be chosen.

⁴¹ HVL measurement errors of up to 10% can result using a Farmer-type chamber in a lightly-filtered 100 kV beam. If the chamber energy response varies by more than 2% over the quality range, then each measurement must be converted to an air-kerma measurement using an air-kerma calibration factor appropriate for each filtered or unfiltered beam. This is an iterative process because the calibration factor itself is determined by the HVL.

9.4.2. Determination of absorbed dose under reference conditions

The general formalism is given in Section 3. The absorbed dose to water at the reference depth z_{ref} in water, in a medium-energy x-ray beam of quality Q and in the absence of the chamber, is given by

$$D_{w,Q} = M_Q N_{D,w,Q_o} k_{Q,Q_o} \quad (9.1)$$

where M_Q is the reading of the dosimeter with the reference point of the chamber positioned at z_{ref} in accordance with the reference conditions given in Section 9.4.1 and corrected for the influence quantities temperature and pressure, polarity, and electrometer calibration, as described in the Worksheet (see also Section 4.4.3). The correction for polarity is likely to be negligible. However it should be checked at least once, and there is provision for this in the Worksheet. Alternatively, if the same polarity that was used for calibration is always used for clinical measurements the effect will cancel. The ionic recombination is negligible when the absorbed-dose rate is less than a few grays per minute (see Ref. [101]). N_{D,w,Q_o} is the calibration factor in terms of absorbed dose to water for the dosimeter at the reference quality Q_o and k_{Q,Q_o} is a chamber-specific factor which corrects for differences between the reference beam quality Q_o and the actual beam quality being used Q . Note also that the correction for timer error may be significant. It is not a multiplicative correction, and is therefore treated separately in the Worksheet.

9.5. Values for k_{Q,Q_o}

Bragg-Gray theory can not be applied to ionization chambers in medium-energy x-rays [103] and therefore the values for k_{Q,Q_o} must be obtained directly from measurements. Generic values, measured for a particular chamber type, should not be used because of large chamber-to-chamber variations in k_{Q,Q_o} with HVL. (See Fig 9.1)

The calibration data for the dosimeter should ideally be presented as a single calibration factor N_{D,w,Q_o} determined in a reference beam of quality Q_o and one or more measured factors k_{Q,Q_o} corresponding to the other calibration qualities Q . However, if the calibration data are in the form of a set of calibration factors $N_{D,w,Q}$ then one of the qualities should be chosen as the reference beam quality Q_o . If the dosimeter has also been calibrated in a ^{60}Co beam, this should be taken as the reference quality. But if the calibrations have been done in medium-energy x-rays only, then one of the qualities should be chosen as the reference beam quality Q_o ⁴². The corresponding calibration factor becomes N_{D,w,Q_o} and the other calibration factors $N_{D,w,Q}$ are expressed in terms of k_{Q,Q_o} using the relation

$$k_{Q,Q_o} = \frac{N_{D,w,Q}}{N_{D,w,Q_o}} \quad (9.2)$$

If the quality of the user beam does not match any of the calibration qualities, the value for k_{Q,Q_o} to be used in Eq. (9.1) can be interpolated (see Worksheet).

A chamber calibrated in a series of beam qualities may be subsequently re-calibrated at only the reference quality Q_o . In this case the new value for N_{D,w,Q_o} should be used with the values of k_{Q,Q_o} previously measured. However, because of the particular susceptibility of ionization chambers to change in energy response to medium-energy x-rays, it is preferable that chambers are re-calibrated at all qualities each time. In particular, if N_{D,w,Q_o} changes by an amount more than the uncertainty stated for the calibration, or there have been any repairs to the chamber, then the dosimeter should be re-

⁴² The choice here is not critical; the quality corresponding to the $N_{D,w,Q}$ factor with the smallest uncertainty is appropriate, otherwise a quality close to the middle of the range.

calibrated at all qualities.

9.6. Measurements under non-reference conditions

9.6.1. Central axis depth-dose distributions

A measurement under reference conditions prescribed in this Code of Practice provides absorbed dose at the depth of 2 g cm^{-2} in water. In order to relate this measurement to the dose at other depths it is usually necessary to obtain the central axis depth-dose distribution. An estimate of the depth dose distribution may be obtained from the literature [81]. However, it is unlikely that the published data will match the exact kV and HVL of the clinical beam. Therefore, it is recommended that the depth-dose distributions be measured for each clinical beam.

In spite of kilovoltage x-rays having been used in radiotherapy for some decades, the methods of relative dosimetry have not been extensively researched. According to Seuntjens *et al* [104], a Farmer-type cylindrical chamber that is suitable for reference dosimetry should have a response in a phantom which is reasonably independent of depth and field size. However a chamber of this type cannot be reliably used at depths in a phantom of less than about 0.5 cm. Depending on the field size and beam energy, there may be a significant variation in the absorbed dose in the first few millimetres of the depth-dose distribution (see Fig 9.3).

It is possible to measure the depth-dose distribution using a small ionization chamber in a scanning tank, as used for relative dosimetry in high-energy electron and photon beams, or using a plane-parallel chamber of the type used for high-energy electron dosimetry [105]. This has the advantage of allowing measurements at depths of less than 0.5 cm. However, these chamber types are not designed for use with kV x-rays and so the relationship between the depth-ionization distribution and the depth-dose distribution (at depths greater than 0.5 cm) must be determined by comparison with a Farmer-type cylindrical chamber at a number of suitable depths. (The depth of measurement of a cylindrical chamber in a phantom is taken to be the depth of the central axis of the chamber.) In most cases, differences between the two chamber types are likely to be no more than a few percent [100, 106]. Further assurance of the accuracy of a particular chamber type can be gained by comparing with published data [81], at least for beams for which these data are available.

Because of the overlap in the ranges of low-energy and medium-energy x-rays, the method of depth-dose measurement using a plastic phantom as described in Section 8.6.1 may be used below 100 kV and 3 mm of aluminium HVL. It may be possible to use the method at higher kV or HVL, but only a plastic that has been shown to give measurements that agree within a few percent with measurements in a water phantom should be used. When making measurements near the surface, there must always be sufficient material thickness to ensure full build-up of secondary electrons. The total thickness required can be estimated from the *csda* range of the maximum-energy electrons in the material used (see Table 8.I for 80-100 kV or ICRU Report 37 [66]).

Some detectors that are used routinely for scanning high-energy beams (photons, electrons, etc) are not suitable for use in medium-energy x-rays because of excessive variation in response with beam quality at kilovoltage energies. Film dosimetry and semiconductor diodes are not suitable for this reason. Some TLD materials are suitable, but the energy response must be checked against an ionization chamber before use.

9.6.2. Output factors

For clinical applications, output factors are required for all combinations of SSD and field size used for radiotherapy treatment. The output factor for medium-energy x-rays is the ratio of the absorbed dose at the surface of a water phantom for a given SSD and field size to the absorbed dose measured under reference conditions (reference conditions are given in Table 9.I). It is generally not possible to make reliable measurements directly at the surface of a phantom since there must be sufficient depth to provide full build-up of secondary electrons. The method recommended in this Code of Practice to

obtain the output factor for each combination of SSD and field size is to measure the absorbed dose to water at the depth of 2 g cm^{-2} relative to the absorbed dose measured under reference conditions for that beam quality, and then to obtain the absorbed dose at the surface by extrapolation using a depth-dose distribution measured as described in Section 9.6.1.

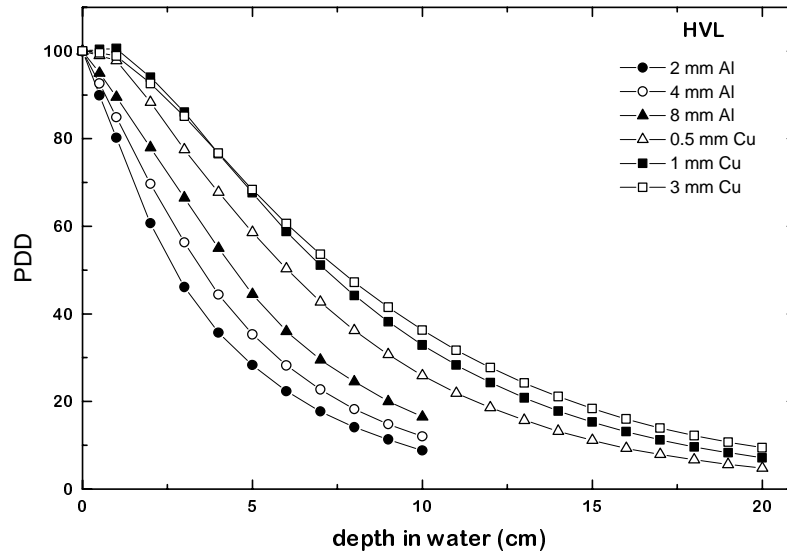

Fig. 9.3. Depth dose data for medium-energy x-rays. Data taken from BJR Suppl. 25 [81].

Beam details: 2, 4 and 8 mm Al 10 cm diameter 20 cm SSD
 0.5, 1, and 3 mm Cu 10 cm x 10 cm 50 cm SSD

9.7. Estimated uncertainty in the determination of absorbed dose to water under reference conditions

There is to date very little practical experience in standards of absorbed dose for medium-energy x-rays. The uncertainty in $N_{D,w,Q}$ determined directly from a primary standard is taken here to be 1%. Alternatively, if the absorbed dose to water is derived from a standard of air kerma, the uncertainty in the determination of $N_{D,w,Q}$ is estimated as 3%. In the latter case, the uncertainty of $N_{D,w,Q}$ then dominates the overall uncertainty.

The x-ray output from some machines depends on line voltage, tube temperature, and operator control of tube current and voltage. This uncertainty should be separately estimated by the user from the standard deviation of a set of at least five exposures of typical treatment length. It is not included in this analysis.

Because the dose gradient from beams at the lower end of the energy range may be as large as 1% per millimetre, there may be difficulty in achieving a depth positioning reproducibility of better than 1%, so this uncertainty is assigned to the establishment of reference conditions.

For medium-energy x-ray dosimetry, the values for k_{Q,Q_0} are derived directly from the calibration factors $N_{D,w,Q}$. If the value of N_{D,w,Q_0} used in Eq. (9.1) is the same as that used in Eq. (9.2), then the uncertainty in the product $k_{Q,Q_0} N_{D,w,Q_0}$ is just the uncertainty in $N_{D,w,Q}$ together with an additional 1.0% to account for the uncertainty of matching the calibration and user beams on the basis of HVL. However, if the N_{D,w,Q_0} used in Eq. (9.1) is different because it has been obtained from a subsequent calibration of the dosimeter, then the uncertainty in k_{Q,Q_0} is increased because of the lack of correlation

between the new N_{D,w,Q_0} and that used to calculate the k_{Q,Q_0} . This results in an increase in the combined standard uncertainty of $D_{w,Q}$ of up to 0.5%.

The uncertainties are summarized in Table 9.II.

TABLE 9.II. ESTIMATED RELATIVE STANDARD UNCERTAINTY ^a OF $D_{w,Q}$ AT THE REFERENCE DEPTH IN WATER FOR A MEDIUM-ENERGY X-RAY BEAM

Physical quantity or procedure	Relative standard uncertainty (%)			
	<i>SSDL</i>	<i>SSDL</i>	<i>PSDL</i>	<i>PSDL</i>
<i>Step 1: Standards Laboratory</i>				
N_{D,w,Q_0} or N_K calibration of secondary standard at PSDL	1.0	0.5		
Long term stability of secondary standard	0.1	0.1		
N_{D,w,Q_0} calibration of the user dosimeter at the standards lab				
Absorbed-dose standard	0.5		1.0	
Derived from air-kerma standard		3.0		3.0
<i>Combined uncertainty in Step 1</i>	<i>1.2</i>	<i>3.0</i>	<i>1.0</i>	<i>3.0</i>
<i>Step 2: User x-ray beam</i>				
Long-term stability of user dosimeter			0.3	
Establishment of reference conditions			1.0	
Dosimeter reading M_Q relative to timer or beam monitor			0.1	
Correction for influence quantities k_i			0.8	
Beam quality correction, k_{Q,Q_0}			1.0	
<i>Combined uncertainty in Step 2</i>			<i>1.6</i>	
Combined standard uncertainty of $D_{w,Q}$ (Steps 1 + 2)	2.0	3.4	1.9	3.0

^a See ISO Guide to the expression of uncertainty [32] or Appendix D. The estimates given in the table should be considered typical values; these may vary depending on the uncertainty quoted by standards laboratories for calibration factors and on the experimental uncertainty at the user institution.

9.8. Worksheet

Determination of the absorbed dose to water in a medium-energy x-ray beam

User: _____ Date: _____

1. Radiation treatment unit and reference conditions for $D_{w,Q}$ determination

x-ray machine: _____ Nominal tube potential: _____ kV
 Nominal tube current: _____ mA Beam quality, Q (HVL): _____ mm
 Al Cu
 Reference phantom: water Reference depth: 2 g cm⁻²
 Reference field size: _____ cm x cm Reference SSD: _____ cm

2. Ionization chamber and electrometer

Ionization chamber model: _____ Serial no.: _____

Chamber wall material: _____ thickness = _____ g cm⁻²

Waterproof sleeve material: _____ thickness = _____ g cm⁻²

Phantom window material: _____ thickness = _____ g cm⁻²

Absorbed-dose-to-water calibration factor N_{D,w,Q_o} = _____ Gy nC⁻¹ Gy rdg⁻¹

Reference beam quality, Q_o (HVL): _____ mm Al Cu

Reference conditions for calibration P_o : _____ kPa T_o : _____ °C Rel. humidity: _____%

Polarizing potential V : _____ V Calibration polarity: +ve -ve corrected for polarity effect

User polarity: +ve -ve

Calibration laboratory: _____ Date: _____

Electrometer model: _____ Serial no.: _____

Calibrated separately from chamber: yes no Range setting: _____

If yes Calibration laboratory: _____ Date: _____

3. Dosimeter reading^a and correction for influence quantities

Uncorrected dosimeter reading at V and user polarity: _____ nC rdg

Corresponding time: _____ min

Ratio of dosimeter reading and time^b: $M =$ _____ nC min⁻¹ rdg min⁻¹

(i) Pressure P : _____ kPa Temperature T : _____ °C Rel. humidity (if known): _____%

$$k_{TP} = \frac{(273.2 + T) P_o}{(273.2 + T_o) P} = \underline{\hspace{2cm}}$$

(ii) Electrometer calibration factor^c k_{elec} : nC rdg⁻¹ dimensionless $k_{elec} = \underline{\hspace{2cm}}$

(iii) Polarity correction^d rdg at + V : $M_+ =$ _____ rdg at - V : $M_- =$ _____

$$k_{pol} = \frac{|M_+| + |M_-|}{2M} = \underline{\hspace{2cm}}$$

Corrected dosimeter reading at the voltage V :

$$M_Q = M k_{TP} k_{elec} k_{pol} = \underline{\hspace{2cm}} \quad \text{or} \quad \text{rdg min}^{-1} \quad \text{or} \quad \text{rdg min}^{-1}$$

4. Absorbed dose rate to water at the reference depth, z_{ref}

Beam quality correction factor for user quality Q :

$$k_{Q,Q_0} = \underline{\hspace{2cm}}$$

at Q_0 (HVL) = _____ mm Al Cu

Calibration laboratory: _____ Date: _____

or Beam quality correction factor interpolated:

$$(k_{Q,Q_0})_1 = \underline{\hspace{2cm}} \text{ at HVL}_1 = \underline{\hspace{2cm}} \text{ mm } \input{checkbox} \text{ Al } \input{checkbox} \text{ Cu } \text{ Date: } \underline{\hspace{2cm}}$$

$$(k_{Q,Q_0})_2 = \underline{\hspace{2cm}} \text{ at HVL}_2 = \underline{\hspace{2cm}} \text{ mm } \input{checkbox} \text{ Al } \input{checkbox} \text{ Cu } \text{ Date: } \underline{\hspace{2cm}}$$

$$k_{Q,Q_0} = (k_{Q,Q_0})_1 + [(k_{Q,Q_0})_2 - (k_{Q,Q_0})_1] \left[\frac{\ln \text{HVL} - \ln \text{HVL}_1}{\ln \text{HVL}_2 - \ln \text{HVL}_1} \right] = \underline{\hspace{2cm}}$$

Absorbed-dose rate calibration at z_{ref} :

$$D_{w,Q}(z_{ref}) = M_Q N_{D,w,Q_0} k_{Q,Q_0} = \underline{\hspace{2cm}} \text{ Gy min}^{-1}$$

5. Absorbed dose rate to water at the depth of dose maximum, z_{max}

Depth of dose maximum: $z_{max} = \underline{\hspace{2cm}} \text{ g cm}^{-2}$

Percentage depth dose at z_{ref} for _____ cm x _____ cm field size: $PDD(z_{ref}=2 \text{ g cm}^{-2}) = \underline{\hspace{2cm}} \%$

Absorbed-dose rate calibration at z_{max} :

$$D_{w,Q}(z_{max}) = 100 D_{w,Q}(z_{ref}) / PDD(z_{ref}) = \underline{\hspace{2cm}} \text{ Gy min}^{-1}$$

^a All readings should be checked for leakage and corrected if necessary

^b The timer error should be taken into account. The correction at voltage V can be determined according to

M_A is the integrated reading in a time t_A $M_A = \underline{\hspace{2cm}}$ $t_A = \underline{\hspace{2cm}}$ min

M_B is the integrated reading in n short exposures of time t_B/n each ($2 \leq n \leq 5$) $M_B = \underline{\hspace{2cm}}$ $t_B = \underline{\hspace{2cm}}$ min $n = \underline{\hspace{2cm}}$

$$\text{Timer error, } \tau = \frac{M_B t_A - M_A t_B}{n M_A - M_B} = \underline{\hspace{2cm}} \text{ min (the sign of } \tau \text{ must be taken into account)}$$

$$M = \frac{M_A}{t_A + \tau} = \underline{\hspace{2cm}} \input{checkbox} \text{ nC min}^{-1} \input{checkbox} \text{ rdg min}^{-1}$$

^c If the electrometer is not calibrated separately set $k_{elec} = 1$

^d M in the denominator of k_{pol} denotes reading at the user polarity. Preferably, each reading in the equation should be the average of the ratios of M (or M_+ or M_-) to the reading of an external monitor, M_{em} .

10. CODE OF PRACTICE FOR PROTON BEAMS

10.1. General

This Section provides a Code of Practice for reference dosimetry (beam calibration) and recommendations for relative dosimetry in proton beams with energies in the range from 50 MeV to 250 MeV. It is based upon a calibration factor in terms of absorbed dose to water N_{D,w,Q_0} for a dosimeter in a reference beam of quality Q_0 ⁴³.

At present, there are two main clinical applications for proton beams (see Ref. [107]). Relatively low-energy protons (less than 90 MeV) are employed in the treatment of ocular tumours using field sizes smaller than 4 cm by 4 cm and high dose rates. Higher-energy protons (above 150 MeV) are used for the treatment of large or deep-seated tumours. For these applications, field sizes and dose rates similar to those used with high-energy photons are employed.

A typical depth-dose distribution for a therapeutic proton beam is shown in Figure 10.1a. This consists of a region where the dose increases slowly with depth, called the “plateau”, and a region where the dose rises rapidly to a maximum, called the “Bragg peak”. Clinical applications require a relatively uniform dose to be delivered to the volume to be treated and for this purpose the proton beam has to be spread out both laterally and in depth. This is obtained at a treatment depth by the superposition of Bragg peaks of different intensities and energies. The technique is called “beam modulation” and creates a region of high dose uniformity referred to as the “spread-out Bragg peak” (SOBP), see Figure 10.1b. The width of the SOBP is normally defined by the width of the 95% dose levels. Spreading out of a Bragg peak can be achieved by different modulation techniques such as energy modulation [108] or raster scanning or dynamic spot scanning [107, 109]; for the latter, the beam modulation can be part of a more complex scanning technique in three dimensions. Some treatments use the plateau region to treat the target with the Bragg peak falling beyond the distal side of the patient [110].

Clinical proton dosimetry to date has been based on different types of dosimeters, such as calorimeters, ionization chambers, Faraday cups, track detectors, activation systems and diodes [108, 111, 112]. Existing proton dosimetry protocols [113-115] provide recommendations for ionization chamber dosimetry, based on in-air calibrations in a ⁶⁰Co beam in terms of exposure or air kerma. The recent ICRU Report No 59 [116] discusses, in addition, the determination of absorbed dose in a proton beam using ionization chambers calibrated in a ⁶⁰Co beam in terms of absorbed dose to water; however, only a general description with little detail is provided.

10.2. Dosimetry equipment

10.2.1. Ionization chambers

The recommendations regarding ionization chambers given in Section 4.2.1 should be followed. Both cylindrical and plane-parallel ionization chambers are recommended for use as reference instruments for the calibration of clinical proton beams. However, the combined standard uncertainty in D_w for plane-parallel ionization chambers will be slightly higher than for cylindrical chambers due to their higher uncertainty for p_{wall} in the ⁶⁰Co reference beam quality (see Table 10.IV and Appendix B). For this reason, cylindrical ionization chambers are preferred for reference dosimetry; their use is, however, limited to proton beams with qualities at the reference depth $R_{res} \geq 0.5 \text{ g cm}^{-2}$. Graphite walled cylindrical chambers are preferable to plastic walled chambers because of their better long term stability and smaller chamber to chamber variations (see Section. 4.2.1 and Fig 1.2). The reference point for these chambers is

⁴³ As no primary standard of absorbed dose to water for proton beams is yet available, ⁶⁰Co gamma rays will be used as reference beam quality Q_0 for proton dosimetry (see Section 10.5).

taken to be on the central axis of the chamber at the centre of the cavity volume; this point is positioned at the reference depth in the phantom.

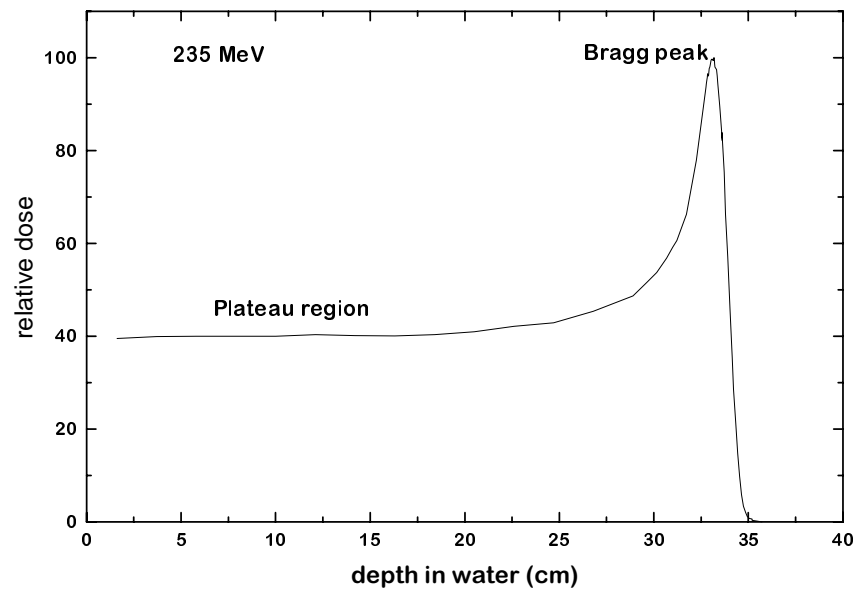

Fig. 10.1a. Percentage depth-dose distribution for a 235 MeV proton beam, illustrating the “plateau” region and the Bragg peak.

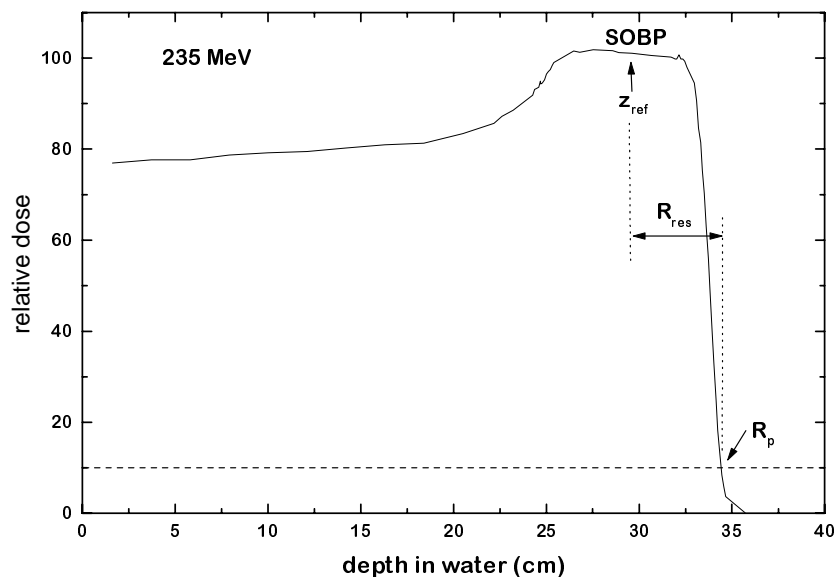

Fig. 10.1b. Percentage depth-dose distribution for a modulated proton beam. Indicated on the figure are the reference depth z_{ref} (middle of the SOBP), the residual range at z_{ref} used to specify the quality of the beam, R_{res} , and the practical range R_p .

Plane-parallel chambers can be used for reference dosimetry in all proton beams, but must be used for proton beams with qualities at the reference depth $R_{res} < 0.5 \text{ g cm}^{-2}$. For these chambers, the reference point is taken to be on the inner surface of the entrance window, at the centre of the window; this point is

positioned at the point of interest in the phantom. The cavity diameter of the plane-parallel ionization chamber or the cavity length of the cylindrical ionization chamber should not be larger than approximately half the reference field size. Moreover, the outer diameter for cylindrical ionization chambers should not be larger than half the SOBP width.

For relative dosimetry, only plane-parallel ionization chambers are recommended. The chamber types for which data are given in the present Code of Practice are listed in Table 10.III.

10.2.2. Phantoms and chamber sleeves

The recommendations regarding phantoms and chamber sleeves given in Sections 4.2.3 and 4.2.4 should be followed. Water is recommended as the reference medium for the determination of absorbed dose and for beam quality measurements with proton beams. The phantom should extend to at least 5 cm beyond all four sides of the field size employed at the depth of measurement and also extend to at least 5 g cm⁻² beyond the maximum depth of measurement.

In horizontal beams, the window of the phantom should be made of plastic and of thickness t_{win} between 0.2 cm and 0.5 cm. The water-equivalent thickness (in g cm⁻²) of the phantom window should be taken into account when evaluating the depth at which the chamber is to be positioned; the thickness is calculated as the product $t_{win} \rho_{pl}$ where ρ_{pl} is the mass density of the plastic (in g cm⁻³). For commonly used plastics PMMA and clear polystyrene, the nominal values $\rho_{PMMA} = 1.19 \text{ g cm}^{-3}$ and $\rho_{polystyrene} = 1.06 \text{ g cm}^{-3}$ [66] may be used for the calculation of the water-equivalent thickness of the window.

For non-waterproof chambers a waterproofing sleeve should be used, made of PMMA, and preferably not thicker than 1.0 mm. The air gap between the chamber wall and the waterproofing sleeve should be sufficient (0.1 mm to 0.3 mm) to allow the air pressure in the chamber to equilibrate. The same waterproofing sleeve that was used for calibration of the user's ionization chamber should also be used for reference dosimetry. If it is not possible to use the same waterproofing sleeve that was used during calibration at the standardizing laboratory, then another sleeve of the same material and of similar thickness should be used. Plane-parallel chambers, if not inherently waterproof or supplied with a waterproof cover, must be used in a waterproof enclosure, preferably of PMMA or a material that closely matches the chamber walls; ideally, there should be no more than 1 mm of added material in front of and behind the cavity volume.

Plastic phantoms should not be used for reference dosimetry in proton beams since the required water-to-plastic fluence correction factors, h_{pl} , are not known. Information on the use of plastic phantoms for relative dosimetry is given in Section 10.6.3.

10.3. Beam quality specification

10.3.1. Choice of beam quality index

In previous proton dosimetry protocols and recommendations [114-116] the proton beam quality was specified by the *effective energy*, which is defined as the energy of a mono-energetic proton beam having a range equal to the residual range R_{res} of the clinical proton beam (see definition below). This choice was justified by the small energy dependence of water/air stopping-power ratios (see figure B.1) and by the fact that the effective energy is close to the maximum energy in the proton energy spectrum at the reference depth (see reference conditions in Table 10.I and Table 10.II).

In the present Code of Practice the residual range, R_{res} , is chosen as the beam quality index. This has the advantage of being easily measurable. Although this choice will slightly underestimate the stopping-power ratios in the middle of the SOBP, this effect is unlikely to exceed 0.3% [116, 117].

The residual range R_{res} (in g cm⁻²) at a measurement depth z is defined as

$$R_{res} = R_p - z \quad (10.1)$$

where z is the depth of measurement and R_p is the practical range (both expressed in $g\ cm^{-2}$), which is defined [116] as the depth at which the absorbed dose beyond the Bragg peak or SOBP falls to 10% of its maximum value (see Figure 10.1b). Unlike other radiation types covered in this Code of Practice, in the case of protons the quality Q is not unique to a particular beam, but is also determined by the reference depth z_{ref} chosen for measurement.

10.3.2. Measurement of beam quality

The residual range R_{res} should be derived from a measured depth-dose distribution, obtained using the conditions given in Table 10.I. The preferred choice of detector for the measurement of central axis depth dose distributions is a plane-parallel chamber. Additional information on the measurement of depth-dose distributions is given in Section 10.6.

TABLE 10.I. REFERENCE CONDITIONS FOR THE DETERMINATION OF PROTON BEAM QUALITY (R_{res})

Influence quantity	Reference value or reference characteristics
Phantom material	water
Chamber type	cylindrical and plane-parallel
Reference point of chamber	for plane-parallel chambers, on the inner surface of the window at its centre. For cylindrical chambers, on the central axis at the centre of the cavity volume
Position of reference point of chamber	for plane-parallel and cylindrical chambers, at the point of interest
SSD	clinical treatment distance
Field size at the phantom surface	10 cm x 10 cm For small field applications (i.e. eye treatments), 10 cm x 10 cm or the largest field clinically available

10.4. Determination of absorbed dose to water

10.4.1. Reference conditions

Reference conditions for the determination of absorbed dose to water in proton beams are given in Table 10.II.

10.4.2. Determination of absorbed dose under reference conditions

The general formalism for the determination of the absorbed dose to water is given in Section 3. The absorbed dose to water at the reference depth z_{ref} in water, in a proton beam of quality Q and in the absence of the chamber is given by

$$D_{w,Q} = M_Q N_{D,w,Q_0} k_{Q,Q_0} \quad (10.2)$$

where M_Q is the reading of the dosimeter with the reference point of the chamber positioned at z_{ref} in accordance with the reference conditions given in Table 10.II, corrected for the influence quantities pressure and temperature, electrometer calibration, polarity effect and ion recombination as described in the Worksheet (see also Section 4.4.3). N_{D,w,Q_0} is the calibration factor in terms of absorbed dose to water for the dosimeter at the reference quality Q_0 and k_{Q,Q_0} is a chamber-specific factor which corrects for differences between the reference beam quality Q_0 and the actual quality being used Q .

TABLE 10.II. REFERENCE CONDITIONS FOR THE DETERMINATION OF ABSORBED DOSE IN PROTON BEAMS

Influence quantity	Reference value or reference characteristics
Phantom material	water
Chamber type	for $R_{res} \geq 0.5 \text{ g cm}^{-2}$, cylindrical and plane-parallel. for $R_{res} < 0.5 \text{ g cm}^{-2}$, plane-parallel.
Measurement depth z_{ref}	middle of the SOBP ^a
Reference point of chamber	for plane-parallel chambers, on the inner surface of the window at its centre. For cylindrical chambers, on the central axis at the centre of the cavity volume
Position of reference point of chamber	for plane-parallel and cylindrical chambers, at the measurement depth z_{ref} .
SSD	clinical treatment distance
Field size at the phantom surface	10 cm x 10 cm, or that used for normalization of the output factors whichever is larger. For small field applications (i.e. eye treatments), 10 cm x 10 cm or the largest field clinically available

^a The reference depth can be chosen in the “plateau region”, at a depth of 3 g cm^{-2} , for clinical applications with a mono-energetic proton beam (e.g. for plateau irradiations).

10.5. Values for k_{Q,Q_0}

Ideally, the values for k_{Q,Q_0} should be obtained by direct measurement of the absorbed dose at the qualities Q and Q_0 , see Eq. (3.3), each measured under reference conditions for the user’s ionization chamber used for proton dosimetry. However, at present no primary standard of absorbed dose to water for proton beams is available. Thus all values for k_{Q,Q_0} given in the present Code of Practice for proton beams are derived by calculation and are based on ^{60}Co gamma radiation as the reference beam quality Q_0 . The notation k_Q denotes this exclusive use of ^{60}Co as the reference quality.

Values for k_Q are calculated using Eq. (3.4). The data for the physical parameters in this equation are discussed in Appendix B. Figure 10.2 shows calculated values for k_Q as a function of the beam quality index R_{res} for some common cylindrical and plane-parallel ionization chamber types. Table 10.III gives calculated values for k_Q as a function of R_{res} for cylindrical and plane-parallel ionization chambers. Values for k_Q for non-tabulated qualities may be obtained by interpolation between tabulated values.

10.6. Measurements under non-reference conditions

Clinical dosimetry requires the measurement of central-axis percentage depth-dose distributions, transverse beam profiles, output factors, etc. Such measurements should be made for all possible combinations of energy, field size and SSD used for radiotherapy treatments. The recommendations given in Section 10.2 regarding choices for ionization chambers and phantoms should be followed.

10.6.1. Central-axis depth-dose distributions

For measurements of depth-dose distributions, the use of plane-parallel chambers is recommended. The measured depth-ionization distribution must be converted to a depth-dose distribution due to the depth dependence of the stopping-power ratio $s_{w,air}$, particularly in the low-energy region. This is achieved by multiplying the measured ionization charge or current at each depth z by the stopping-power ratio $s_{w,air}$ and the perturbation factor at that depth. Values for $s_{w,air}$ as a function of R_{res} can be calculated from Eq. (B.13) given in Appendix B. Perturbation factors are assumed to have a value of unity, see Appendix B. The influence of ion recombination and polarity effects on the depth-ionization distribution should be investigated and taken into account if there is a variation with depth.

If the field size for which measurements are to be performed is smaller than twice the diameter of the cavity of the plane-parallel chamber, then a detector with a better spatial resolution (e.g. mini-chamber, diode or diamond) is recommended. The resulting distribution must also be converted using the appropriate stopping-power ratios (e.g. water-to-air, water-to-silicon or water-to-graphite). For the latter, the necessary stopping-power values can be found in ICRU Report No 49 [118]. The suitability of such detectors for depth-dose measurements should be verified by test comparisons with a plane-parallel chamber at a larger field size.

For clinical proton beams produced by dynamic beam delivery systems (i.e. spot scanning), measurement times should be long enough compared to the scanning cycle of the field in order to yield reproducible readings.

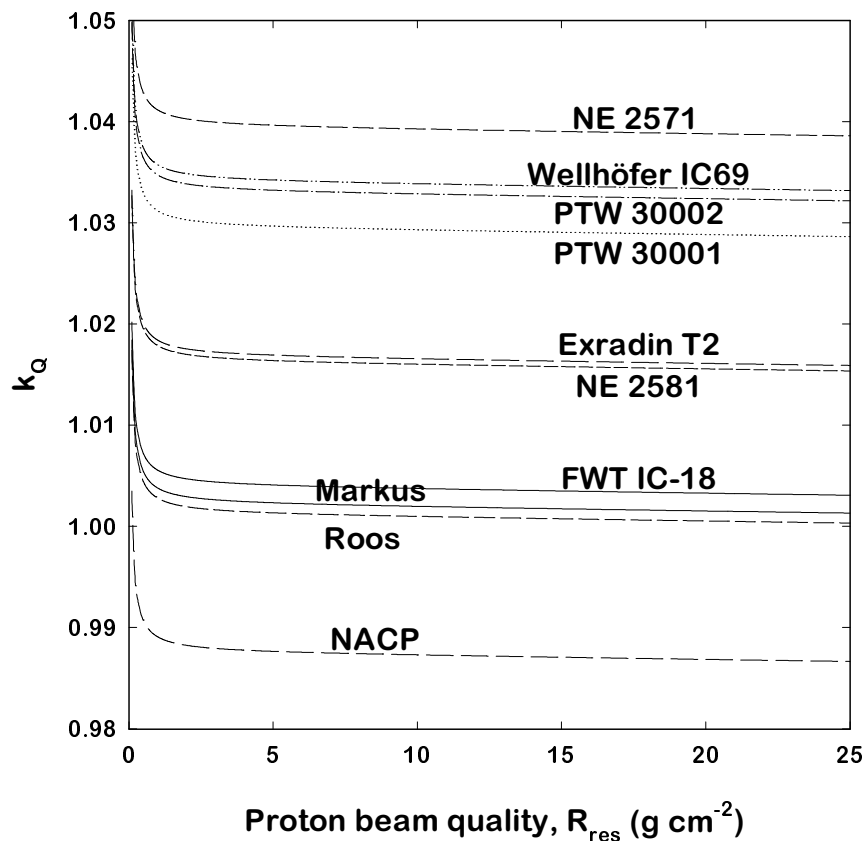

Fig 10.2. Calculated values of k_Q for various cylindrical and plane-parallel ionization chambers commonly used for reference dosimetry, as a function of proton beam quality Q (R_{res}). Data from Table 10.III.

10.6.2. Output factors

The output factor may be determined as the ratio of corrected dosimeter readings at the reference depth z_{ref} measured under a given set of non-reference conditions relative to that measured under reference conditions (reference conditions are given in Table 10.II). For a given proton beam, output factors should be measured for all non-reference field sizes and SSDs used for patient treatments.

Ionization chamber type ^a	Beam quality R_{res} (g cm ⁻²)															
	0.25	0.5	1	1.5	2	2.5	3	3.5	4	4.5	5	7.5	10	15	20	30
PTW 23333	-	1.033	1.031	1.031	1.030	1.030	1.030	1.030	1.030	1.030	1.030	1.029	1.029	1.029	1.029	1.028
PTW 30001/30010 Farmer	-	1.033	1.031	1.031	1.030	1.030	1.030	1.030	1.030	1.030	1.030	1.029	1.029	1.029	1.029	1.028
PTW 30002/30011 Farmer	-	1.036	1.035	1.034	1.034	1.034	1.034	1.033	1.033	1.033	1.033	1.033	1.033	1.033	1.032	1.032
PTW 30004/30012 Farmer	-	1.044	1.042	1.041	1.041	1.041	1.041	1.041	1.041	1.041	1.040	1.040	1.040	1.040	1.040	1.039
PTW 30006/30013 Farmer	-	1.033	1.032	1.031	1.031	1.031	1.030	1.030	1.030	1.030	1.030	1.029	1.029	1.029	1.029	1.029
PTW 31002 flexible	-	1.032	1.030	1.029	1.029	1.029	1.029	1.029	1.029	1.029	1.029	1.028	1.028	1.028	1.028	1.027
PTW 31003 flexible	-	1.032	1.030	1.029	1.029	1.029	1.029	1.029	1.029	1.029	1.029	1.028	1.028	1.028	1.028	1.027
SNC 100730 Farmer	-	1.035	1.033	1.032	1.032	1.032	1.032	1.032	1.032	1.032	1.031	1.031	1.031	1.031	1.031	1.030
SNC 100740 Farmer	-	1.046	1.044	1.044	1.043	1.043	1.043	1.043	1.043	1.043	1.043	1.043	1.042	1.042	1.042	1.042
Victoreen Radocon III 550	-	1.031	1.030	1.029	1.029	1.028	1.028	1.028	1.028	1.028	1.028	1.028	1.028	1.027	1.027	1.027
Victoreen Radocon II 555	-	1.014	1.012	1.011	1.011	1.011	1.011	1.011	1.011	1.011	1.011	1.011	1.010	1.010	1.010	1.010
Victoreen 30-348	-	1.023	1.022	1.021	1.021	1.021	1.020	1.020	1.020	1.020	1.020	1.020	1.020	1.020	1.019	1.019
Victoreen 30-351	-	1.026	1.024	1.023	1.023	1.023	1.023	1.023	1.023	1.022	1.022	1.022	1.022	1.022	1.022	1.021
Victoreen 30-349	-	1.030	1.028	1.027	1.027	1.027	1.027	1.027	1.027	1.026	1.026	1.026	1.026	1.026	1.026	1.025
Victoreen 30-361	-	1.023	1.021	1.020	1.020	1.020	1.020	1.020	1.020	1.020	1.020	1.019	1.019	1.019	1.019	1.018
Wellhöfer IC 05	-	1.041	1.039	1.039	1.038	1.038	1.038	1.038	1.038	1.038	1.038	1.037	1.037	1.037	1.037	1.036
Wellhöfer IC 06	-	1.041	1.039	1.039	1.038	1.038	1.038	1.038	1.038	1.038	1.038	1.037	1.037	1.037	1.037	1.036
Wellhöfer IC 10	-	1.041	1.039	1.039	1.038	1.038	1.038	1.038	1.038	1.038	1.038	1.037	1.037	1.037	1.037	1.036
Wellhöfer IC 15	-	1.041	1.039	1.039	1.038	1.038	1.038	1.038	1.038	1.038	1.038	1.037	1.037	1.037	1.037	1.036
Wellhöfer IC 25	-	1.041	1.039	1.039	1.038	1.038	1.038	1.038	1.038	1.038	1.038	1.037	1.037	1.037	1.037	1.036
Wellhöfer IC 28 Farmer shortened	-	1.041	1.040	1.039	1.039	1.038	1.038	1.038	1.038	1.038	1.038	1.038	1.038	1.037	1.037	1.037
Wellhöfer IC 69 Farmer	-	1.037	1.036	1.035	1.035	1.035	1.035	1.034	1.034	1.034	1.034	1.034	1.034	1.034	1.033	1.033
Wellhöfer IC 70 Farmer	-	1.043	1.042	1.041	1.041	1.040	1.040	1.040	1.040	1.040	1.040	1.040	1.040	1.039	1.039	1.039
<i>Plane-parallel chambers</i>																
Attix RMI 449	0.995	0.992	0.990	0.989	0.989	0.989	0.989	0.989	0.989	0.989	0.989	0.988	0.988	0.988	0.988	0.987
Capintec PS-033	1.029	1.026	1.024	1.024	1.023	1.023	1.023	1.023	1.023	1.023	1.023	1.022	1.022	1.022	1.022	1.021
Exradin P11	1.000	0.997	0.995	0.994	0.994	0.994	0.994	0.994	0.994	0.994	0.993	0.993	0.993	0.993	0.993	0.992
Holt (Memorial)	1.014	1.010	1.009	1.008	1.008	1.008	1.008	1.008	1.008	1.007	1.007	1.007	1.007	1.007	1.007	1.006
NACP / Calcam	0.994	0.991	0.989	0.989	0.988	0.988	0.988	0.988	0.988	0.988	0.988	0.987	0.987	0.987	0.987	0.986
Markus	1.009	1.005	1.004	1.003	1.003	1.003	1.003	1.003	1.002	1.002	1.002	1.002	1.002	1.002	1.002	1.001
Roos	1.008	1.004	1.003	1.002	1.002	1.002	1.002	1.002	1.001	1.001	1.001	1.001	1.001	1.001	1.001	1.000

^a Some of the chambers listed in this table fail to meet some of the minimum requirements described in Section 4.2.1. However, they have been included in this table because of their current clinical use

10.6.3. Use of plastic phantoms for relative dosimetry

The use of plastic phantoms is strongly discouraged, as in general they are responsible for discrepancies in the determination of absorbed dose. Plastic phantoms should not be used for reference dosimetry in proton beams since the required water-to-plastic fluence correction factors, h_{pl} , are not known. Nevertheless, when accurate chamber positioning in water is not possible or when no waterproof chamber is available, their use is permitted for the measurement of depth dose distributions for low-energy proton beams (approximately below 100 MeV). In this case, the dosimeter reading at each plastic depth should be scaled using the fluence scaling factor h_{pl} . It is assumed that h_{pl} has constant value of unity at all depths.

The criteria determining the choice of plastic materials are discussed in Section 4.2.3. The density of the plastic, ρ_{pl} , should be measured for the batch of plastic in use rather than using a nominal value for the plastic type. Each measurement depth in plastic z_{pl} (expressed in g cm^{-2}) must also be scaled to give the corresponding depth in water z_w by

$$z_w = z_{pl} c_{pl} \text{ g cm}^{-2} \quad (z_{pl} \text{ in g cm}^{-2}) \quad (10.3)$$

where c_{pl} is a depth-scaling factor. For proton beams, c_{pl} can be calculated, to a good approximation, as the ratio of csda ranges (in g cm^{-2}) [118] in water and in plastic. The depth scaling factor c_{pl} has a value of 0.974 for PMMA and 0.981 for clear polystyrene. The procedure given in Section 10.6.1 should be followed to generate central-axis depth-dose distributions from the measured depth-ionization distributions.

If a plastic phantom is used to measure the beam quality index, the measured quantity is the residual range in the plastic, $R_{res,pl}$. The residual range, R_{res} , in water is also obtained using the scaling Eq. (10.3).

10.7. Estimated uncertainty in the determination of absorbed dose to water under reference conditions

The uncertainties associated with the physical quantities and procedures involved in the determination of the absorbed dose to water in the user proton beam can be divided into two steps. Step 1 considers uncertainties up to the calibration of the user chamber in terms of $N_{D,w}$ at a standards laboratory. Step 2 deals with the subsequent calibration of the user proton beam using this chamber and includes the uncertainty of k_Q as well as that associated with measurements at the reference depth in a water phantom. Estimates of the uncertainties in these two steps are given in Table 10.IV, yielding a combined standard uncertainty of 2% and 2.3% for the determination of the absorbed dose to water in a clinical proton beam with a cylindrical and plane-parallel ionization chamber, respectively. Details on the uncertainty estimates for the various physical parameters entering in the calculation of k_Q are given in Appendix B.

TABLE 10.IV. ESTIMATED RELATIVE STANDARD UNCERTAINTY ^a OF $D_{w,Q}$ AT THE REFERENCE DEPTH IN WATER AND FOR A CLINICAL PROTON BEAM, BASED ON A CHAMBER CALIBRATION IN ⁶⁰Co GAMMA RADIATION

Physical quantity or procedure	User chamber type:	Relative standard uncertainty (%)	
		cylindrical	plane-parallel
<i>Step 1: Standards Laboratory</i>		<i>SSDL</i> ^b	<i>SSDL</i> ^b
$N_{D,w}$ calibration of secondary standard at PSDL		0.5	0.5
Long term stability of secondary standard		0.1	0.1
$N_{D,w}$ calibration of the user dosimeter at the standards laboratory		0.4	0.4
<i>Combined uncertainty in Step 1</i>		<i>0.6</i>	<i>0.6</i>
<i>Step 2: User proton beam</i>			
Long-term stability of user dosimeter		0.3	0.4
Establishment of reference conditions		0.4	0.4
Dosimeter reading M_Q relative to beam monitor		0.6	0.6
Correction for influence quantities k_i		0.4	0.5
Beam quality correction, k_Q		1.7	2.0
<i>Combined uncertainty in Step 2</i>		<i>1.9</i>	<i>2.2</i>
Combined standard uncertainty in $D_{w,Q}$ (Steps 1 + 2)		2.0	2.3

^a See ISO Guide to the expression of uncertainty [32] or Appendix D. The estimates given in the table should be considered typical values; these may vary depending on the uncertainty quoted by standards laboratories for calibration factors and on the experimental uncertainty at the user's institution.

^b If the calibration of the user dosimeter is performed at a PSDL then the combined standard uncertainty in Step 1 is lower. The combined standard uncertainty in D_w should be adjusted accordingly.

10.8. Worksheet

Determination of the absorbed dose to water in a proton beam

User: _____ Date: _____

1. Radiation treatment unit and reference conditions for $D_{w,Q}$ determination

Proton therapy unit: _____ Nominal energy: _____ MeV
 Nominal dose rate: _____ MU min⁻¹ Practical range, R_p : _____ g cm⁻²
 Reference phantom: water Width of the SOBP: _____ g cm⁻²
 Reference field size: _____ cm x cm Reference SSD: _____ cm
 Reference depth, z_{ref} : _____ g cm⁻² Beam quality, $Q(R_{res})$: _____ g cm⁻²

2. Ionization chamber and electrometer

Ionization chamber model: _____ Serial no.: _____ Type: cyl pp
 Chamber wall / window material: _____ thickness: _____ g cm⁻²
 Waterproof sleeve / cover material: _____ thickness: _____ g cm⁻²
 Phantom window material: _____ thickness: _____ g cm⁻²

Absorbed-dose-to-water calibration factor $N_{D,w} =$ _____ Gy nC⁻¹ Gy rdg⁻¹

Reference conditions for calibration P_o : _____ kPa T_o : _____ °C Rel. humidity: _____%

Polarizing potential V_I : _____ V Calibration polarity: +ve -ve corrected for polarity effect

User polarity: +ve -ve

Calibration laboratory: _____ Date: _____

Electrometer model: _____ Serial no.: _____

Calibrated separately from chamber: yes no Range setting: _____

If yes Calibration laboratory: _____ Date: _____

3. Dosimeter reading^a and correction for influence quantities

Uncorrected dosimeter reading at V_I and user polarity: _____ nC rdg

Corresponding accelerator monitor units: _____ MU

Ratio of dosimeter reading and monitor units: $M_I =$ _____ nC MU⁻¹ rdg MU⁻¹

(i) Pressure P : _____ kPa Temperature T : _____ °C Rel. humidity (if known): _____%

$$k_{TP} = \frac{(273.2 + T) P_o}{(273.2 + T_o) P} = \underline{\hspace{2cm}}$$

(ii) Electrometer calibration factor^b k_{elec} : nC rdg⁻¹ dimensionless $k_{elec} = \underline{\hspace{2cm}}$

(iii) Polarity correction^c rdg at $+V_I$: $M_+ = \underline{\hspace{2cm}}$ rdg at $-V_I$: $M_- = \underline{\hspace{2cm}}$

$$k_{pol} = \frac{|M_+| + |M_-|}{2M} = \underline{\hspace{2cm}}$$

(iv) Recombination correction (two-voltage method)

Polarizing voltages: V_1 (normal) = _____ V V_2 (reduced) = _____ V

Readings^d at each V: M_1 = _____ M_2 = _____

Voltage ratio V_1 / V_2 = _____ Ratio of readings M_1 / M_2 = _____

Use Table 4.VII for a beam of type: pulsed pulsed-scanned

a_0 = _____ a_1 = _____ a_2 = _____

$$k_s = a_0 + a_1 \left(\frac{M_1}{M_2} \right) + a_2 \left(\frac{M_1}{M_2} \right)^2 = \text{_____} \quad \text{e, f}$$

Corrected dosimeter reading at the voltage V_1 :

$$M_Q = M_1 k_{TP} k_{elec} k_{pol} k_s = \text{_____} \quad \square \text{ nC MU}^{-1} \quad \square \text{ rdg MU}^{-1}$$

4. Absorbed dose to water at the reference depth, z_{ref}

Beam quality correction factor for user quality Q : k_Q = _____

taken from Table 10.III Other, specify: _____

Absorbed-dose calibration of monitor at z_{ref} :

$$D_{w,Q}(z_{ref}) = M_Q N_{D,w} k_Q = \text{_____ Gy MU}^{-1}$$

^a All readings should be checked for leakage and corrected if necessary

^b If the electrometer is not calibrated separately set $k_{elec} = 1$

^c M in the denominator of k_{pol} denotes reading at the user polarity. Preferably, each reading in the equation should be the average of the ratios of M (or M_+ or M_-) to the reading of an external monitor, M_{em} .

It is assumed that the calibration laboratory has performed a polarity correction. Otherwise k_{pol} is determined according to

rdg at $+V_1$ for quality Q_0 : M_+ = _____ rdg at $-V_1$ for quality Q_0 : M_- = _____

$$k_{pol} = \frac{[(|M_+| + |M_-|)/|M|]_{Q_0}}{[(|M_+| + |M_-|)/|M|]_{Q_0}} = \text{_____}$$

^d Strictly, readings should be corrected for polarity effect (average with both polarities). Preferably, each reading in the equation should be the average of the ratios of M_1 or M_2 to the reading of an external monitor, M_{em} .

^e It is assumed that the calibration laboratory has performed a recombination correction. Otherwise the factor $k'_s = k_s / k_{s,Q_0}$ should be used instead of k_s . When Q_0 is ^{60}Co , k_{s,Q_0} (at the calibration laboratory) will normally be close to unity and the effect of not using this equation will be negligible in most cases.

^f Check that $k_s - 1 \approx \frac{M_1/M_2 - 1}{V_1/V_2 - 1}$

11. CODE OF PRACTICE FOR HEAVY-ION BEAMS

11.1. General

This Section provides a Code of Practice for reference dosimetry (beam calibration) and recommendations for relative dosimetry in heavy-ion beams. It is based on a calibration factor in terms of absorbed dose to water of an ionization chamber in a reference beam which, owing to the lack of primary standards for heavy ions, is taken to be ^{60}Co gamma rays. The Code of Practice applies to heavy-ion beams with atomic numbers between 2(He) and 18(Ar) which have ranges of 2 g cm^{-2} to 30 g cm^{-2} in water. For a carbon beam, this corresponds to an energy range of 100 to 450 MeV/u.

In the same way as for proton beams (see Section 10), the depth dose distribution of a monoenergetic heavy-ion beam in water, shown in Fig. 11.1, has a sharp Bragg peak near the region where primary particles stop. For clinical applications of heavy-ion beams, spread-out Bragg peaks (SOBP) are generated so that they include the complete target volume inside the SOBP. As opposed to most of the therapeutic radiation beams (excluding neutrons), owing to the strong dependence of the biological response on the energy of heavy ions in clinical applications it is common to use a *biological effective dose* [119, 120] instead of a *physical dose* (absorbed dose to water). The difference between the two kinds of distributions can be seen in Figs. 11.2a and 11.2b, where the lack of uniformity of the physical dose distribution in the SOBP is obvious. As is well known, the biological effective dose is defined as the physical absorbed dose multiplied by the Relative Biological Effectiveness (RBE) of the beam for the tissue under consideration. In the case of heavy ions the RBE varies with depth and with dose delivered to the tissue. The use of a biological effective dose makes it possible to compare results obtained with conventional radiotherapy to those using heavy-ion radiotherapy.

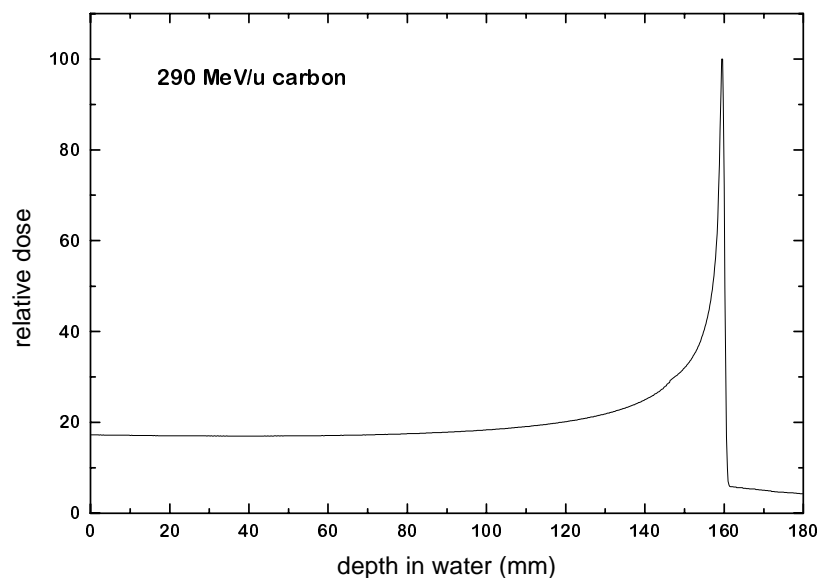

Fig.11.1. Depth dose distribution of a monoenergetic 290 MeV/u carbon beam in water.

In this Code of Practice, however, the dosimetry of heavy ions is restricted to the determination of the physical dose using standards of absorbed dose to water disseminated through an ionization chamber calibrated in terms of absorbed dose to water, N_{D,w,Q_0} . The reason for this limited approach is based on the feasibility of using the same formalism and procedures for all the radiotherapy beams used

throughout the world, to achieve international consistency in dosimetry. The robustness of a common framework for radiotherapy dosimetry will encourage correlated comparisons of the delivery of absorbed dose to patients, reducing the number of degrees of freedom in comparing the outcome of a radiotherapy treatment. Biological studies can then be made on the basis of uniform dosimetry procedures.

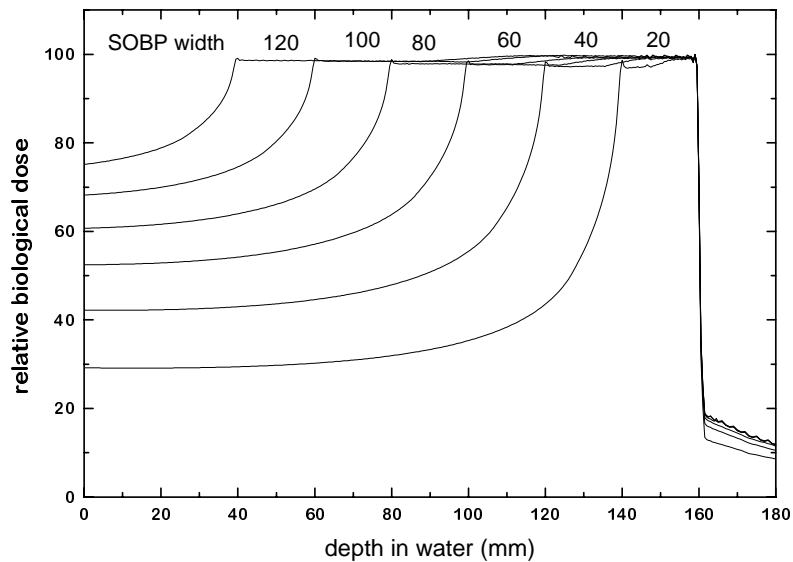

Fig. 11.2a. Biological dose distributions of therapeutic carbon beams of energy 290 MeV/u. SOBPs of 20 to 120 mm width are designed to yield uniform biological effect in the peaks [120, 121].

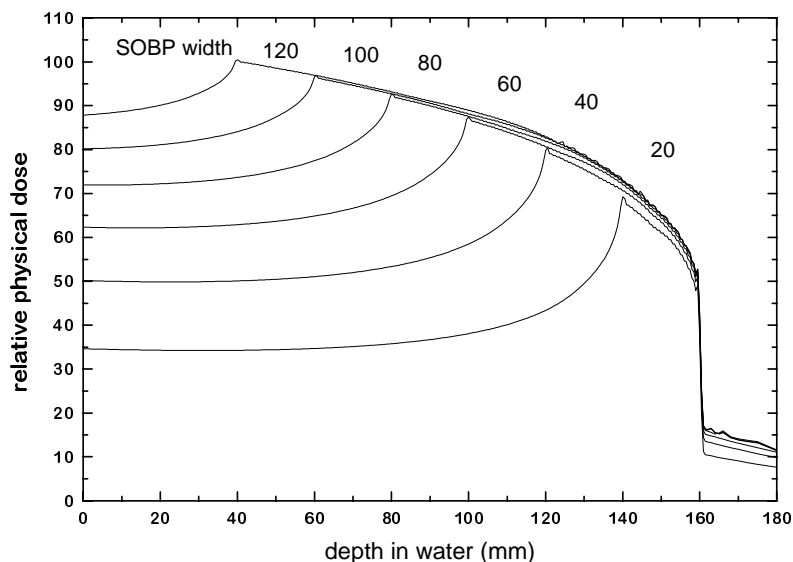

Fig. 11.2b. Physical dose distributions of the beam shown in Fig 11.2(a) [120, 121].

Heavy-ion beams used in radiotherapy have a distinct physical characteristic for radiation dosimetry compared to other therapeutic radiation beams [122]. In the case of high-energy protons, incident particles interact with target nuclei and produce low-energy protons or heavy ions. When heavy ions pass through beam modulating devices or human tissues, they produce nuclei fragmented from the projectile and the target nuclei. The nuclei produced by fragmentation have approximately the same

velocity as the incident heavy ions, and fragmented nuclei reach deeper regions than those where the incident particles stop. Many kinds of atomic nuclei are present, all with different energy distributions. This fragmentation of projectiles and targets affects considerably the biological response to heavy-ion beams influencing the dosimetry of heavy ions. Compared with the depth dose distribution of a proton beam (see Fig. 10.1), Fig 11.1 shows a tail at the distal end of the Bragg peak which is due to the fragmentation of the incident particles.

Up to now, the only dosimetry recommendations available were those of the protocol by the AAPM TG-20 in 1984 [113]. The lack of a modern protocol for heavy ions has motivated recent intercomparisons of carbon beam dosimetry using different approaches [123, 124]. There is thus a need for a new protocol in order to establish a global consistency in the determination of absorbed dose to water with heavy ions, common to dosimetry protocols for other radiotherapy beams. Absorbed dose in heavy-ion beams can be measured using an ionization chamber or a calorimeter. Fluence measurement methods can also be applied for the determination of the absorbed dose of mono-energetic beams [113]. In the present Code of Practice only the method based on ionometric measurements is discussed.

For an accurate determination of absorbed dose from heavy-ion beams using an ionization chamber, it is desirable to know the energy spectra of the incident heavy-ion beam, the projectile fragments and also of the target fragmented nuclei. Very few experimental and theoretical data on the spectral distribution of heavy-ion beams are available [125-127]. Thus, simplified values for the physical parameters required in heavy-ion dosimetry with ionization chambers will be adopted in this Code of Practice f

11.2. Dosimetry equipment

11.2.1. Ionization chambers

The recommendations regarding ionization chambers given in Section 4.2.1 should be followed. Cylindrical and plane-parallel ionization chambers are recommended for use as reference instruments in clinical heavy-ion beams. However, the combined standard uncertainty on $D_{w,Q}$ for plane-parallel ionization chambers will be slightly higher due to their higher uncertainty for p_{wall} in the ^{60}Co reference beam quality (see Table 11.III and the discussion in Appendix B). For this reason, cylindrical ionization chambers are preferred for reference dosimetry. However, their use is limited to heavy-ion beams with a SOBP width $\geq 2.0 \text{ g cm}^{-2}$. Graphite walled cylindrical chambers are preferred to plastic walled chambers because of their better long term stability and smaller chamber to chamber variations. (see Sec. 4.2.1 and Fig 1.2). The reference point for these chambers is taken to be on the central axis of the chamber at the centre of the cavity volume. In the case of heavy-ion beams, an effective point of measurement of the chamber, P_{eff} , should be used because the depth-dose distribution in the SOBP is not flat and the slope depends on the width of the SOBP [123]. The reference point of the cylindrical chamber should be positioned a distance $0.75 r_{cyl}$ deeper than the point of interest in the phantom, where r_{cyl} is the inner radius of the chamber.

Plane-parallel chambers can be used for reference dosimetry in all heavy-ion beams, but must be used for heavy-ion beams with a SOBP width $< 2.0 \text{ g cm}^{-2}$. For plane-parallel ionization chambers, the reference point is taken to be on the inner surface of the entrance window, at the centre of the window. This point is positioned at the point of interest in the phantom. The cavity diameter of the plane-parallel ionization chamber or the cavity length of the cylindrical ionization chamber should not be larger than approximately half the reference field size.

For relative dosimetry, only plane-parallel ionization chambers are recommended. The chamber types for which data are given in the present Code of Practice are listed in Table 11.II.

11.2.2. Phantoms and chamber sleeves

The recommendations regarding phantoms and chamber sleeves given in Sections 4.2.3 and 4.2.4 should be followed. Water is recommended as the reference medium for measurements of absorbed dose in heavy-ion beams. The phantom should extend to at least 5 cm beyond all four sides of the field size employed at the depth of measurement and also extend to at least 5 g cm⁻² beyond the maximum depth of measurement.

In horizontal beams, the window of the phantom should be made of plastic and of thickness t_{win} between 0.2 cm and 0.5 cm. The water-equivalent thickness (in g cm⁻²) of the phantom window should be taken into account when evaluating the depth at which the chamber is to be positioned; the thickness is calculated as the product $t_{win} \rho_{pl}$ where ρ_{pl} is the mass density of the plastic (in g cm⁻³). Efforts should be made to obtain information about the density of plastic of which the phantom is made. For commonly used plastics PMMA and clear polystyrene, the nominal values $\rho_{PMMA} = 1.19 \text{ g cm}^{-3}$ and $\rho_{polystyrene} = 1.06 \text{ g cm}^{-3}$ [66] may be used for the calculation of the water-equivalent thickness of the window.

For non-waterproof chambers a waterproofing sleeve should be used, made of PMMA, and preferably not thicker than 1.0 mm. The air gap between the chamber wall and the waterproofing sleeve should be sufficient (0.1 mm to 0.3 mm) to allow the air pressure in the chamber to equilibrate. The same waterproofing sleeve that was used for calibration of the user's ionization chamber should also be used for reference dosimetry. If it is not possible to use the same waterproofing sleeve that was used during calibration at the standardizing laboratory, then another sleeve of the same material and of similar thickness should be used. Plane-parallel chambers, if not inherently waterproof or supplied with a waterproof cover, must be used in a waterproof enclosure, preferably of PMMA or a material that closely matches the chamber walls; ideally, there should be no more than 1 mm of added material in front of and behind the cavity volume.

Plastic phantoms should not be used for reference dosimetry in heavy-ion beams since the required water-to-plastic fluence correction factors, h_{pl} , are not known. Moreover, the fluence of heavy ions including fragmented particles in a plastic phantom will be different from that in a water phantom. However, plastic phantoms can be used for routine quality assurance measurements, provided a transfer factor between plastic and water has been established.

11.3. Beam quality specification

Very few experimental and theoretical data on the spectral distributions of heavy-ion beams are available. The current practice for characterizing a heavy-ion beam is to use the atomic number, mass number, energy of the incident heavy-ion beam, width of SOBP and range.

11.4. Determination of absorbed dose to water

11.4.1. Reference conditions

As shown in Fig. 11.2b, the SOBP of a heavy-ion depth-dose distribution is not flat, and the dose at the distal end of the SOBP is smaller than that at the proximal part. The slope near the centre of a broad SOBP is rather small whereas that of a narrow SOBP is steep. The reference depth for calibration should be taken at the centre of SOBP, at the centre of the target volume.

Reference conditions for the determination of absorbed dose to water are given in Table 11.I.

TABLE 11.I. REFERENCE CONDITIONS FOR THE DETERMINATION OF ABSORBED DOSE IN HEAVY-ION BEAMS

Influence quantity	Reference value or reference characteristics
Phantom material	water
Chamber type	for SOBP width $\geq 2.0 \text{ g cm}^{-2}$, cylindrical and plane-parallel chambers. For SOBP width $< 2.0 \text{ g cm}^{-2}$, plane-parallel chambers
Measurement depth z_{ref}	middle of the SOBP
Reference point of chamber	for plane-parallel chambers, on the inner surface of the window at its centre. For cylindrical chambers, on the central axis at the centre of the cavity volume
Position of reference point of chamber	for plane-parallel chambers, at the measurement depth z_{ref} . For cylindrical chambers, $0.75 r_{cyl}$ deeper than z_{ref}
SSD	clinical treatment distance
Field size at the phantom surface	10 cm x 10 cm, or that used for normalization of the output factors whichever is larger. For small field applications ($< 10 \text{ cm x 10 cm}$) the largest field clinically available

11.4.2. Determination of absorbed dose under reference conditions

The formalism for the determination of the absorbed dose to water using heavy-ion beams follows the presentation given in Section 3. The absorbed dose to water at the reference depth z_{ref} in water, in a heavy-ion beam of quality Q and in the absence of the chamber is given by

$$D_{w,Q} = M_Q N_{D,w,Q_o} k_{Q,Q_o} \quad (11.1)$$

where M_Q is the reading of the dosimeter corrected for the influence quantities temperature and pressure, electrometer calibration, polarity effect and ion recombination as described in the Worksheet (see also Section 4.4.3). The chamber should be positioned in accordance with the reference conditions, as given in Table 11.I. N_{D,w,Q_o} is the calibration factor in terms of absorbed dose to water for the dosimeter at the reference quality Q_o and k_{Q,Q_o} is a chamber specific factor which corrects for the differences between the reference beam quality Q_o and the actual beam quality Q . Because Q_o corresponds to ^{60}Co , the beam quality correction factor is denoted by k_Q .

11.4.2.1. Recombination correction in heavy-ion beams

When beams are generated by scanning techniques, the dose rate is very high and general recombination effects must be taken into account. The correction factor for general recombination should be obtained experimentally by the two voltage method [128] as discussed in Sec.4.4.3.4.

When general recombination is negligible, initial recombination should be taken into account for heavy-ion beams, especially when the dose is measured using plane-parallel ionization chambers. The collected ionization current should be fitted by the linear relation,

$$1/i_{col} = 1/i_{\infty} + b/V \quad (11.2)$$

where V is the polarizing voltage applied to the chamber. The correction factor is given by $k_s^{ini} = i_{\infty} / i_{col}$.

11.5. Values for k_{Q,Q_0}

Since beam quality specifications are not currently used for the dosimetry of heavy-ion beams k_Q values depend only on the chamber type used. Experimental values of the factor k_{Q,Q_0} are not readily available and, therefore, in the present document only theoretical values will be used. The correction factor is defined by equation (3.4), i.e.

$$k_{Q,Q_0} = \frac{(s_{w,air})_Q (W_{air})_Q P_Q}{(s_{w,air})_{Q_0} (W_{air})_{Q_0} P_{Q_0}} \quad (11.3)$$

At present no primary standard of absorbed dose to water for heavy-ion beams is available. Thus all values for k_{Q,Q_0} given in the present Code of Practice for heavy ions are derived by calculation and are based on ^{60}Co gamma radiation as the reference beam quality Q_0 . The notation k_Q denotes this exclusive use of ^{60}Co as the reference quality.

The factors appearing in the numerator must be evaluated for the heavy-ion beam of quality Q , and due to the complexity of the physical processes involved, their determination represents a considerable undertaking. There is currently no information available on perturbation factors for ion chambers in heavy-ion beams, and in what follows they will be assumed to be identical to unity.

The stopping power ratios and W-values for heavy-ion beams are taken to be independent of the beam quality, owing to a current lack of experimental data. The contribution of fragmented nuclei to stopping power ratios and W values are also assumed to be negligible. Constant values of the stopping power ratio and W-value are therefore adopted here for all heavy-ion beams. These are 1.130 and 34.50 eV respectively. Note that the W-value corresponds to dry air. As the stopping power ratio $s_{w,air}$ of heavy ions is so close to that of ^{60}Co , the k_Q values for heavy ions are dominated by the ratio of W_{air} values and the chamber specific perturbation factors at ^{60}Co .

Table 11.II gives values of k_Q for various cylindrical and plane-parallel ionization chambers in common use.

11.6. Measurements under non-reference conditions

For clinical use, depth dose distributions, transverse beam profiles, penumbra size of the radiation fields, and output factors for the various conditions of treatments with heavy-ion beams should be measured.

Plane-parallel ionization chambers are recommended for the measurement of depth dose distributions. For the measurement of transverse profiles or three dimensional dose distributions, very small chambers having a cavity volume less than about 0.1 cm^3 can be used. For dosimeters other than ionization chambers, the energy dependence of the detector response should be checked against ionization chambers.

TABLE 11.II. CALCULATED VALUES OF k_Q FOR HEAVY-ION BEAMS, FOR VARIOUS CYLINDRICAL AND PLANE-PARALLEL IONIZATION CHAMBERS

Ionization chamber type ^a	k_Q
<i>Cylindrical chambers</i>	
Capintec PR-05P mini	1.045
Capintec PR-05 mini	1.045
Capintec PR-06C/G Farmer	1.037
Exradin A2 Spokas	1.055
Exradin T2 Spokas	1.018
Exradin A1 mini Shonka	1.043
Exradin T1 mini Shonka	1.007
Exradin A12 Farmer	1.042
Far West Tech IC-18	1.006
FZH TK 01	1.031
Nuclear Assoc 30-750	1.035
Nuclear Assoc 30-749	1.039
Nuclear Assoc 30-744	1.039
Nuclear Assoc 30-716	1.039
Nuclear Assoc 30-753 Farmer shortened	1.040
Nuclear Assoc 30-751 Farmer	1.036
Nuclear Assoc 30-752 Farmer	1.042
NE 2515	1.032
NE 2515/3	1.041
NE 2577	1.041
NE 2505 Farmer	1.032
NE 2505/A Farmer	1.019
NE 2505/3, 3A Farmer	1.041
NE 2505/3, 3B Farmer	1.023
NE 2571 Farmer	1.041
NE 2581 Farmer	1.018
NE 2561 / 2611 Sec Std	1.038
PTW 23323 micro	1.026
PTW 23331 rigid	1.035
PTW 23332 rigid	1.029
PTW 23333	1.031
PTW 30001/30010 Farmer	1.031
PTW 30002/30011 Farmer	1.035
PTW 30004/30012 Farmer	1.042
PTW 30006/30013 Farmer	1.032
PTW 31002 flexible	1.030
PTW 31003 flexible	1.030
SNC 100730 Farmer	1.033
SNC 100740 Farmer	1.044
Victoreen Radocon III 550	1.030
Victoreen Radocon II 555	1.012
Victoreen 30-348	1.022
Victoreen 30-351	1.024
Victoreen 30-349	1.028
Victoreen 30-361	1.021
Wellhöfer IC 05	1.039
Wellhöfer IC 06	1.039
Wellhöfer IC 10	1.039

Ionization chamber type ^a	k_Q
Wellhöfer IC 15	1.039
Wellhöfer IC 25	1.039
Wellhöfer IC 28 Farmer shortened	1.040
Wellhöfer IC 69 Farmer	1.036
Wellhöfer IC 70 Farmer	1.042
<i>Plane-parallel chambers</i>	
Attix RMI 449	0.990
Capintec PS-033	1.024
Exradin P11	0.995
Holt (Memorial)	1.009
NACP / Calcam	0.989
Markus	1.004
Roos	1.003

^a Some of the chambers listed in this table fail to meet some of the minimum requirements described in Section 4.2.1. However, they have been included in this table because of their current clinical use.

11.7. Estimated uncertainty in the determination of absorbed dose to water under reference conditions

At present, uncertainties in the dosimetry of heavy ions are rather large compared with the dosimetry of other radiotherapy beams. For the calculated k_Q factors given in this Code of Practice, the uncertainties are dominated by those of the stopping-power ratio and W -value. Detailed comparisons between ionization chamber dosimetry and water calorimetry are still necessary for further developments in the field. Also a more comprehensive investigation on projectile and target fragmentation is necessary to improve the dosimetry of heavy ions. The estimated uncertainties given in Table 11.III should therefore be regarded as preliminary.

TABLE 11.III. ESTIMATED RELATIVE STANDARD UNCERTAINTY ^a OF $D_{w,Q}$ AT THE REFERENCE DEPTH IN WATER AND FOR A CLINICAL HEAVY-ION BEAM, BASED ON A CHAMBER CALIBRATION IN ⁶⁰Co GAMMA RADIATION

Physical quantity or procedure	User chamber type:	Relative standard uncertainty (%)	
		cylindrical	plane-parallel
<i>Step 1: Standards Laboratory</i>		<i>SSDL</i> ^b	<i>SSDL</i> ^b
$N_{D,w}$ calibration of secondary standard at PSDL		0.5	0.5
Long term stability of secondary standard		0.1	0.1
$N_{D,w}$ calibration of the user dosimeter at the standard laboratory		0.4	0.4
<i>Combined uncertainty in Step 1</i>		<i>0.6</i>	<i>0.6</i>
<i>Step 2: User heavy-ion beam</i>			
Long-term stability of user dosimeter		0.3	0.4
Establishment of reference conditions		0.4	0.6
Dosimeter reading M_Q relative to beam monitor		0.6	0.6
Correction for influence quantities k_i		0.4	0.5
Beam quality correction, k_Q		2.8	3.2
<i>Combined uncertainty in Step 2</i>		<i>2.9</i>	<i>3.0</i>
Combined standard uncertainty in $D_{w,Q}$ (Steps 1 + 2)		3.0	3.4

^a See ISO Guide to the expression of uncertainty [32] or Appendix D. The estimates given in the table should be considered typical values; these may vary depending on the uncertainty quoted by standards laboratories for calibration factors and on the experimental uncertainty at the user's institution.

^b If the calibration of the user dosimeter is performed at a PSDL then the combined standard uncertainty in Step 1 is lower. The combined standard uncertainty in D_w should be adjusted accordingly.

11.8. Worksheet

Determination of the absorbed dose to water in a heavy-ion beam

User: _____ Date: _____

1. Radiation treatment unit and reference conditions for $D_{w,Q}$ determination

Heavy ion therapy unit: _____ Nominal energy: _____ MeV
 Nominal dose rate: _____ MU min⁻¹ ion used: _____
 Reference phantom: water Width of the SOBP: _____ g cm⁻²
 Reference field size: _____ cm x cm Reference SSD: _____ cm
 Reference depth z_{ref} : _____ g cm⁻²

2. Ionization chamber and electrometer

Ionization chamber model: _____ Serial no.: _____ Type: pp cyl

Chamber wall / window material: _____ thickness: _____ g cm⁻²

Waterproof sleeve / cover material: _____ thickness: _____ g cm⁻²

Phantom window material: _____ thickness: _____ g cm⁻²

Absorbed-dose-to-water calibration factor $N_{D,w}$ = _____ Gy nC⁻¹ Gy rdg⁻¹

Reference conditions for calibration P_o : _____ kPa T_o : _____ °C Rel. humidity: _____%

Polarizing potential V_I : _____ V Calibration polarity: +ve -ve corrected for polarity effect

User polarity: +ve -ve

Calibration laboratory: _____ Date: _____

Electrometer model: _____ Serial no.: _____

Calibrated separately from chamber: yes no Range setting: _____

If yes Calibration laboratory: _____ Date: _____

3. Dosimeter reading^a and correction for influence quantities

Uncorrected dosimeter reading at V_I and user polarity: _____ nC rdg

Corresponding accelerator monitor units: _____ MU

Ratio of dosimeter reading and monitor units: M_I = _____ nC MU⁻¹ rdg MU⁻¹

(i) Pressure P : _____ kPa Temperature T : _____ °C Rel. humidity (if known): _____%

$$k_{TP} = \frac{(273.2 + T) P_o}{(273.2 + T_o) P} = \underline{\hspace{2cm}}$$

(ii) Electrometer calibration factor^b k_{elec} : nC rdg⁻¹ dimensionless $k_{elec} = \underline{\hspace{2cm}}$

(iii) Polarity correction^c rdg at $+V_I$: M_+ = _____ rdg at $-V_I$: M_- = _____

$$k_{pol} = \frac{|M_+| + |M_-|}{2M} = \underline{\hspace{2cm}}$$

(iv) Recombination correction (two-voltage method)

Polarizing voltages: V_1 (normal) = _____ V V_2 (reduced) = _____ V

Readings^d at each V: M_1 = _____ M_2 = _____

Voltage ratio V_1 / V_2 = _____ Ratio of readings M_1 / M_2 = _____

Use Table 4.VII for a beam of type: pulsed pulsed-scanned

a_0 = _____ a_1 = _____ a_2 = _____

$$k_s = a_0 + a_1 \left(\frac{M_1}{M_2} \right) + a_2 \left(\frac{M_1}{M_2} \right)^2 = \text{_____} \quad \text{e, f}$$

(v) Recombination correction (initial recombination):

Polarizing voltage (V): V_1 = _____ V_2 = _____ V_3 = _____ V_4 = _____

Average readings at each voltage M_1 = _____ M_2 = _____ M_3 = _____ M_4 = _____

Coefficients of linear fitting: M_∞ = _____ b = _____

$$1/M = 1/M_\infty + b/V$$

$$k_s^{ini} = \frac{M_\infty}{M_1} = \text{_____}$$

Corrected dosimeter reading at the voltage V_1 :

$$M_Q = M_1 k_{TP} k_{elec} k_{pol} k_s k_s^{ini} = \text{_____} \quad \text{input nC MU}^{-1} \quad \text{input rdg MU}^{-1}$$

4. Absorbed dose to water at the reference depth, z_{ref}

Beam quality correction factor for user quality Q : k_Q = _____

taken from Table 11.II Other, specify: _____

Absorbed-dose calibration of monitor at z_{ref} :

$$D_{w,Q}(z_{ref}) = M_Q N_{D,w} k_Q = \text{_____ Gy MU}^{-1}$$

^a All readings should be checked for leakage and corrected if necessary

^b If the electrometer is not calibrated separately set $k_{elec} = 1$

^c M in the denominator of k_{pol} denotes reading at the user polarity. Preferably, each reading in the equation should be the average of the ratios of M (or M_+ or M_-) to the reading of an external monitor, M_{em} .

It is assumed that the calibration laboratory has performed a polarity correction. Otherwise k_{pol} is determined according to

rdg at $+V_1$ for quality Q_0 : M_+ = _____ rdg at $-V_1$ for quality Q_0 : M_- = _____

$$k_{pol} = \frac{[(|M_+| + |M_-|)/|M|]_{Q_0}}{[(|M_+| + |M_-|)/|M|]_{Q_0}} = \text{_____}$$

^d Strictly, readings should be corrected for polarity effect (average with both polarities). Preferably, each reading in the equation should be the average of the ratios of M_1 or M_2 to the reading of an external monitor, M_{em} .

^e It is assumed that the calibration laboratory has performed a recombination correction. Otherwise the factor $k'_s = k_s / k_{s,Q_0}$ should be used instead of k_s . When Q_0 is ^{60}Co , k_{s,Q_0} (at the calibration laboratory) will normally be close to unity and the effect of not using this equation will be negligible in most cases.

^f Check that $k_s - 1 \approx \frac{M_1/M_2 - 1}{V_1/V_2 - 1}$

APPENDIX A. RELATION BETWEEN N_K AND $N_{D,w}$ BASED CODES OF PRACTICE

The connection between the $N_K - N_{D,air}$ formalism (used for example in TRS-277 [17] and TRS-381 [21]) and the $N_{D,w}$ formalism used in the present Code of Practice is, in principle, straight forward. There are, however, differences in detector positioning and in the meaning of some correction factors which could lead to errors if the user is not well aware of the changes. For this reason the connection between the two formalisms is presented in detail in this Appendix. An update of the information in TRS-277 was provided in the TRS-381 Code of Practice for plane-parallel ionization chambers (this also includes some changes to the data for cylindrical chambers).

A.1. ^{60}Co and high-energy photon and electron beams

N_K -based protocols determine the absorbed dose to water at a reference depth in a phantom in a two-step process.

In the first step a chamber factor in terms of absorbed dose to the cavity air, $N_{D,air}$, is derived. This is accomplished by relating the air kerma (free in air), K_{air} , to the mean absorbed dose \overline{D}_{air} within the air cavity of the user ionization chamber in a ^{60}Co beam, i.e.,

$$\overline{D}_{air} = K_{air}(1-g)k_{att}k_mk_{cel} \quad (\text{A.1})$$

where the meaning of the factors g , k_{att} and k_m was given in TRS-277. The factor k_{cel} in Eq. (A.1) takes into account the non-air equivalence of the central electrode of a cylindrical ionization chamber during the chamber calibration in terms of air kerma at ^{60}Co (see TRS-381 and references therein). N_K is defined as the ratio of K_{air} to the reading of a dosimeter during calibration at ^{60}Co , M ; in the same way $N_{D,air}$ can be defined as the ratio of \overline{D}_{air} to the same reading, M . In the updated formalism given in TRS-381, $N_{D,air}$ is given by

$$N_{D,air} = N_K(1-g)k_{att}k_mk_{cel} \quad (\text{A.2a})$$

This factor was called N_D in TRS-277 [17], but the subscript “air” was included in TRS-381 [21] to specify without ambiguity that it refers to the absorbed dose to the air of the chamber cavity. This is the N_{gas} of AAPM TG-21 [9]. Equation (A.2a) superseded the equation given in TRS-277, which is

$$N_D = N_K(1-g)k_{att}k_m \quad (\text{A.2b})$$

Note that Eq. (A.2b) in TRS-277 did not include k_{cel} and therefore N_D did not relate solely to the geometrical characteristics of the chamber, as the factor is intended to be an indirect measure of the cavity volume⁴⁴ and therefore a chamber constant. The factor k_{cel} was instead included in TRS-277 in a global factor p_{cel} to account for the combined effect of the central electrode, both during the calibration of the chamber in air in a ^{60}Co beam and during subsequent measurements in photon and electron beams in a phantom. The numerical value of $N_{D,air}$ for cylindrical chambers with a 1 mm diameter aluminium electrode (NE 2571) is a factor 1.006 greater than N_D as given in TRS-277 even if

⁴⁴ Note that if the volume of the chamber, V , were accurately known as is the case in a primary standard ionization chamber, at the calibration quality $N_{D,air}$ would be defined as [12]

$$N_{D,air} = \frac{\overline{D}_{air}}{M} = \frac{1}{V\rho_{air}} \frac{W}{e} \quad (\text{in } \text{J kg}^{-1} \text{C}^{-1} \text{ or Gy C}^{-1})$$

In the $N_{D,air}$ formalism W/e is assumed to be constant for photons and electrons [17], and therefore the factor $N_{D,air}$ depends only on the mass of air ($V\rho_{air}$) inside the cavity; it is thus a constant of the chamber established for certain reference environmental conditions.

the absorbed dose to water at ^{60}Co is the same due to cancellation of the two factors correcting for electrode effects (see below).

It is assumed that the $N_{D,air}$ factor derived at the ^{60}Co quality is also valid at the user quality Q . The factor $N_{D,air}$ then allows the determination of the mean absorbed dose within the air cavity at the user beam quality Q

$$\overline{D}_{air,Q} = M_Q N_{D,air} \quad (\text{A.3})$$

In the second step, the absorbed dose to water, $D_{w,Q}$, at a point in a phantom where the effective point of measurement of the chamber is positioned, is obtained from the dose to air using the Bragg-Gray principle,

$$D_{w,Q}(P_{eff}) = M_Q N_{D,air}(s_{w,air})_Q P_Q \quad (\text{A.4a})$$

where M_Q is the dosimeter reading at the beam quality Q corrected for influence quantities; $s_{w,air}$ is the stopping power ratio, water to air; p_Q is the overall perturbation factor of the ionization chamber for in-phantom measurements at a beam quality Q ; and P_{eff} is the effective point of measurement of the chamber, shifted from the chamber centre towards the source. Note that in TRS-277, where the beam quality Q was denoted by “u” (the user beam quality), the concept of an overall perturbation factor was simplified; for photon and electron beams, p_u was identified, respectively, with the p_{wall} and p_{cav} perturbation factors used in TRS-381 and in the present Code of Practice. It is emphasized that with Eq. (A.4a) the absorbed dose to water is determined at the point where P_{eff} is situated.

As is well known (see Sections 1.6 and 4.2.5), an alternative to the use of the effective point of measurement of the chamber is to consider a perturbation factor p_{dis} that accounts for the effect of replacing a volume of water with the detector cavity, when the reference point of the detector volume is taken to be at the chamber centre. Eq. (A.4a) can be written as

$$D_{w,Q}(\text{centre}) = M_Q N_{D,air}(s_{w,air})_Q P_Q \quad (\text{A.4b})$$

where for clarity the “centre” of the chamber has been spelled in full. The expanded form of the overall perturbation factor becomes

$$P_Q = [p_{cav} p_{dis} p_{wall} p_{cel}]_Q \quad (\text{A.5})$$

and the absorbed dose to water is determined at the position of the chamber centre. The meaning of the different factors has been described in Section 1.6.

Two important remarks need to be made in relation to the correction for the central electrode and to the use of the effective point of measurement:

- (i) when the expressions for $N_{D,air}$ and for p_Q , Eqs. (A.2a) and (A.5) respectively, are inserted into Eq. (A.4b), a product $k_{cel} p_{cel}$ appears due to the effect of the central electrode both in air and in water measurements. This product was called p_{cel} in TRS-277, although it should have been named $p_{cel-gbl}$ to specify without ambiguity that it is a *global* correction factor [21]. Although the values of k_{cel} and p_{cel} practically cancel each other at the quality of ^{60}Co gamma rays, it is important to understand the difference between the p_{cel} used in the present Code of Practice (and in TRS-381) and the $p_{cel-gbl}$ of TRS-277, because only p_{cel} plays a role in the $N_{D,w}$ formalism as no in-air measurements are made.
- (ii) when $D_{w,Q}$ is determined according to Eq. (A.4a), the chamber is positioned with its effective point of measurement at the reference depth where the absorbed dose is required; the chamber

centre is therefore deeper than the reference depth. The use of Eq. (A.4b) requires, on the other hand, that the chamber be positioned with its centre at the reference depth. The two different set-ups are illustrated in Fig. A.1. It is clear that the two situations described by Eqs. (A.4a) and (A.4b) differ by the difference in percent depth-doses between P_{eff} and the chamber centre.

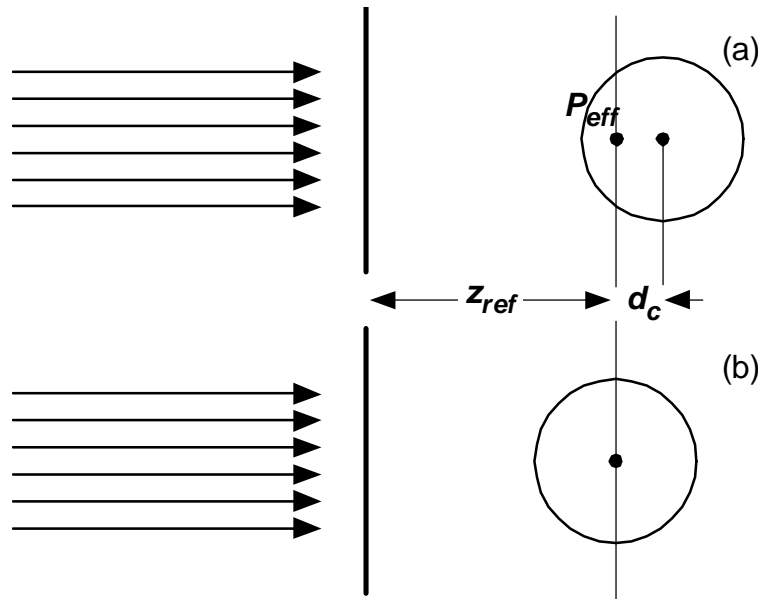

Fig. A.1. In TRS-277 (a) the effective point of measurement of a cylindrical ionization chamber is positioned at the reference depth z_{ref} where the absorbed dose is required; the chamber centre is deeper than z_{ref} a distance d_c equal to the shift of P_{eff} (for example $0.6 r_{cyl}$ for photon beams in TRS-277). Except in electron and heavy-ion beams, in the present Code of Practice (b) the centre of a cylindrical chamber is positioned at the reference depth, z_{ref} , and the absorbed dose is determined at this position.

The connection between the present $N_{D,w}$ formalism and the $N_{D,air}$ formalism is then established comparing Eqs. (3.1) and (A.4b) both for the same reference beam quality Q_o . For the absorbed dose to water D_{w,Q_o} determined at the same reference depth, it follows that

$$N_{D,w,Q_o} = N_{D,air}(s_{w,air})_{Q_o} P_{Q_o} \quad (\text{A.6a})$$

or in expanded form

$$N_{D,w,Q_o} = [N_K(1-g)k_{air}k_mk_{cel}]_{\omega_{Co}}(s_{w,air})_{Q_o} [p_{cav}p_{dis}p_{wall}p_{cel}]_{Q_o} \quad (\text{A.6b})$$

where Q_o usually refers to ^{60}Co gamma rays. The assumed constancy in $N_{D,air}$ allows extending these relations to any reference quality, but the need for determining all the factors entering into $N_{D,air}$ at the quality of ^{60}Co has been emphasized explicitly by the subscript in the first square bracket. It is emphasized that the symbols and their meaning correspond to those given in TRS-381 [21].

Details on the required stopping-power data and perturbation correction factors are included in Appendix B. Factors related to the determination of the $N_{D,air}$ can be found in TRS-277 [17] or TRS-381 [21].

A.1.1. A summary of notations used for calibration factors

The notation used in this Code of Practice for calibration factors is practically identical to that used in TRS-381 [21], but differs somewhat from the symbols used in TRS-277 [17]. A confusion between the different calibration factors might result in a considerable error in the determination of absorbed dose to water during the calibration of a beam, which may affect the radiotherapy treatments of a

large number of patients. For this reason, a summary of the various terms used to denote calibration factors in the IAEA Codes of Practice and other publications is given here.

The chamber factor in terms of absorbed dose to cavity air $N_{D,air}$ was called N_D in ICRU Report 35 [11] and in TRS-277. The subscript ‘air’ was included in TRS-381 to specify without ambiguity that it refers to the absorbed dose to the air of the chamber cavity. This is the symbol used in the present Code of Practice. Extreme care should be paid by the user to avoid confusing $N_{D,air}$, or the former N_D , with the calibration factor in terms of absorbed dose to water $N_{D,w}$.

The calibration factor in terms of absorbed dose to water $N_{D,w}$ was used in TRS-277 for low-energy kV x-rays; this is the only quality at which the calibration factor in terms of absorbed dose to water was applied in that Code of Practice. In TRS-381 it has the same symbol as in the present Code of Practice. The symbol $N_{D,w}$ has also been adopted by AAPM TG-51 [51]. This calibration factor was referred to as N_D in AAPM TG-21 [9], where a relationship between N_{gas} and N_D similar to that described above was given. The symbol N_D is also used in the calibration certificates issued by some standards laboratories and manufacturers instead of $N_{D,w}$.

As there is no uniformity in the adoption of unique symbols for calibration factors, users are advised to exercise extreme caution and confirm the physical quantity used for the calibration of their detectors in order to avoid severe mistakes that could jeopardize radiotherapy treatments. As can be easily seen in Eq. (A.6a) the difference between $N_{D,air}$ and $N_{D,w}$ at ^{60}Co is close to the value of the stopping-power ratio, water to air, in ^{60}Co gamma rays (most perturbation factors are close to unity); a confusion in the meaning of the factors could therefore result in an error in the dose delivered to a patient of approximately 13%.

Examples of notations used in some Codes of Practice, dosimetry protocols, and standards laboratories and manufacturers, to refer to calibration factors at the quality of ^{60}Co gamma rays are given in Table A.I.

Table A.I. EXAMPLES OF NOTATION USED FOR CALIBRATION FACTORS IN TERMS OF ABSORBED DOSE TO THE CAVITY AIR AND ABSORBED DOSE TO WATER AT THE QUALITY OF ^{60}Co GAMMA RAYS

Publication or institution	factor in terms of absorbed dose to the cavity air	factor in terms of absorbed dose to water
This Code of Practice	$N_{D,air}$	$N_{D,w}$
IAEA TRS-381 [21]	$N_{D,air}$	$N_{D,w}$
IAEA TRS-277 [17]	N_D	$N_{D,w}$ ^a
ICRU-35 [11]	N_D	- ^b
ICRU-64 [29]	$N_{D,air}$	$N_{D,w}$
AAPM TG-21 [9]	N_{gas}	N_D
AAPM TG-51 [51]	- ^b	$N_{D,w}$
Some standards laboratories and manufacturers	- ^b	N_D

^a For low energy kV x-rays only

^b Not available or not applicable

A.1.2. Comparison of D_w determinations

As already mentioned in Section 1.4, the adoption of the present Code of Practice will introduce small differences in the value of the absorbed dose to water determined in clinical beams compared with previous Codes of Practice and dosimetry protocols based on standards of air kerma (c.f. TRS-277 [17] and TRS-381 [21]). It was also emphasized that any conclusions drawn from comparisons between protocols based on standards of air kerma and absorbed dose to water must take account of the differences between primary standards. Whereas details on the expected differences in various

situations will be published in the open literature, it is the purpose of this Section to anticipate the expected changes in the most common cases. For a given primary standard, the results of a comparison will depend on the type and quality of the beam and on the type of ionization chamber.

For ^{60}Co gamma radiation, which is generally better characterized than other modalities, beam calibrations based on the two different standards, K_{air} and D_w , differ by typically 1%. Fig. A.2 shows the ratio of absorbed dose to water in ^{60}Co determined with calibration factors in terms of absorbed dose to water and with calibration factors in terms of air kerma together with TRS-277 [17] for some of the ionization chamber types shown in Fig. 1.2. Although the differences lie in most cases within the combined standard uncertainty of the two Codes of Practice, discrepancies of this order are expected when $N_{D,w}$ and N_K calibrations, traceable to the BIPM and to most PSDLs, are used in hospitals and SSDLs. The change may be greater or smaller when calibrations are traceable to laboratories lying at the extremes of the distributions shown in Fig. 2.2. Any systematic discrepancy between the two methods, $N_{D,w}$ and N_K , is most likely to be due to inaccuracies in the numerical factors and expressions (for example k_m , p_{wall} , etc.) used in the N_K -based formalism; in addition, there is a possibility for a systematic effect in air-kerma primary standards [31].

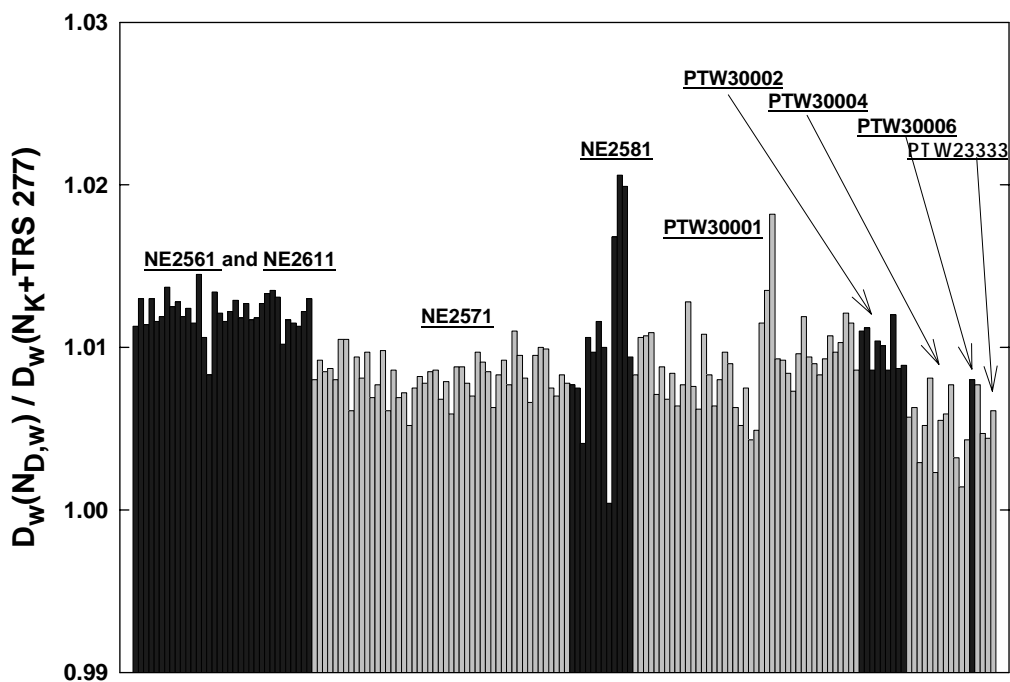

Fig A.2. The ratio of absorbed dose to water in ^{60}Co determined with calibration factors in terms of absorbed dose to water, $N_{D,w}$ and with calibration factors in terms of air kerma, N_K , using the IAEA TRS-277 Code of Practice [17] for some of the ionization chamber types shown in Fig. 1.2. Both calibration factors are traceable to the BIPM. The differences are in most cases within the combined standard uncertainty of the two Codes of Practice based on $N_{D,w}$ and N_K .

In the case of high-energy photon and electron beam calibrations, only the situation involving calculated values of k_Q is discussed here. The change in D_w at ^{60}Co , which is propagated to high-energy beams, is the only significant contribution in high-energy photons, as most of the coefficients and factors involved in the calculation of k_Q factors are the same as in TRS-277 (2nd edition) and no other differences are expected. For electron beams, in addition to the propagated change in D_w at ^{60}Co , the second largest contribution will be due to the implementation of realistic stopping-power ratios $s_{w,air}$ for clinical beams, as the basic data ($s_{w,air}$ for mono-energetic beams) remains practically the same; this will result in changes of the order of 0.5%. As with ^{60}Co , the differences lie within the combined standard uncertainty of the two Codes of Practice based on $N_{D,w}$ and N_K .

A.2. Kilovoltage x-ray beams

For kilovoltage x-ray beams the connection between the two formalisms, $N_{D,w}$ and N_K , is established by different expressions depending on the beam quality.

For medium-energy x-ray beams and measurements made with the centre of a cylindrical chamber at a reference depth of 2 g cm^{-2} in a water phantom, the calibration factor in terms of absorbed dose to water is derived using

$$N_{D,w,Q_0} = N_{K,Q_0} [(\mu_{en}/\rho)_{w,air}]_{Q_0} p_{Q_0} \quad (\text{A.7})$$

where N_{K,Q_0} is the calibration factor in terms of air kerma measured free in air at the Q_0 x-ray calibration quality, $[(\mu_{en}/\rho)_{w,air}]_{Q_0}$ is the ratio of the mean mass energy-absorption coefficient, water to air, at the reference depth and p_{Q_0} is a perturbation factor. The perturbation factor accounts for i) the effect on the chamber response of the difference in spectra at the chamber position for the calibration free in air and at the reference depth in the water phantom, ii) the replacement of water by the air and chamber wall material, iii) the influence of the stem on the chamber response in water and free in air, and iv) the effect on the chamber response of the waterproof sleeve.

The reference depth in TRS-277 was specified as 5 g cm^{-2} ; however, data for $(\mu_{en}/\rho)_{w,air}$ at 2 g cm^{-2} were also given. The data for perturbation factors have been shown to be valid also at 2 g cm^{-2} [104].

For establishing the connection at low-energy x-ray beams, it is necessary to take into account the difference in response of a plane-parallel chamber free in air compared to that on the surface of a full-scatter phantom. This is because N_K based protocols yield the absorbed dose at a phantom surface when a plane-parallel chamber is positioned free in air (see TRS-277, second edition), whereas the $N_{D,w}$ formalism yields the absorbed dose at the surface of a phantom when the chamber is positioned with its reference point at the surface of a phantom. Thus for the air-kerma formalism

$$D_{w,Q_0} = M_{Q_0}^{free\ air} N_{K,Q_0} B [(\mu_{en}/\rho)_{w,air}]_{Q_0}^{free\ air} p_{Q_0} \quad (\text{A.8})$$

where the air-kerma calibration factor N_{K,Q_0} measured free in air includes the effect of any material in which the ion chamber is embedded, B is the backscatter factor, $[(\mu_{en}/\rho)_{w,air}]_{Q_0}^{free\ air}$ is the ratio of the mean mass energy-absorption coefficients in free air, and p_{Q_0} is assumed to be unity for the plane-parallel chambers used. For a formalism based on calibration factor in terms of absorbed dose to water

$$D_{w,Q_0} = M_{Q_0}^{surface} N_{D,w,Q_0} \quad (\text{A.9})$$

From Eqs. (A.8) and (A.9) it follows that

$$N_{D,w,Q_0} = \frac{M_{Q_0}^{free\ air}}{M_{Q_0}^{surface}} N_{K,Q_0} B [(\mu_{en}/\rho)_{w,air}]_{Q_0}^{free\ air} p_{Q_0} \quad (\text{A.10})$$

Data for the various factors in Eqs. (A.7) through (A.10) have been given in the second edition of TRS-277 [17] or may be found in other current dosimetry protocols and Codes of Practice [17, 96, 97]. The relationships given in this Section allow both the comparison of the present Code of Practice with protocols based on calibration factors in terms air kerma, and also the use of the present Code of Practice by means of N_{D,w,Q_0} calibration factors derived from standards of air kerma. A comparison of this Code of Practice with an air-kerma based protocol is effectively a verification of the factors $[(\mu_{en}/\rho)_{w,air}]_{Q_0}$, p_{Q_0} , and B . Because there has been some doubt particularly in the last two, such comparisons will be valuable.

APPENDIX B. CALCULATION OF k_{Q,Q_0} AND ITS UNCERTAINTY

B.1. General

The beam quality correction factor k_{Q,Q_0} is defined by Eq. (3.3). In this Code of Practice, values for k_{Q,Q_0} measured for a particular chamber should be used when available. However, in most cases such data will not be available and calculated values must be used. Under conditions where the Bragg-Gray cavity theory is valid, values for k_{Q,Q_0} may be calculated using Eq. (3.4):

$$k_{Q,Q_0} = \frac{(s_{w,air})_Q (W_{air})_Q p_Q}{(s_{w,air})_{Q_0} (W_{air})_{Q_0} p_{Q_0}} \quad (\text{B.1})$$

In photon and electron beams, the basic mono-energetic data used for electron stopping powers are those given in ICRU Report 37 [66] with the density effect model due to Sternheimer. For proton and heavy ion beams the basic mono-energetic data used for stopping powers are those given in ICRU Report 49 [118].

The value for (W_{air}/e) of $33.97 \text{ J}\cdot\text{C}^{-1}$ [129-131] is used in this Code of Practice for all photon and electron beams. However, in view of some evidence of a possible variation in W_{air} between ^{60}Co and high-energy photon and electron beams [55], a component of uncertainty is included where appropriate. The value for W_{air} used for proton and heavy ion beams is discussed in the relevant sections of this appendix.

In the absence of a consistent data set for perturbation factors, these are necessarily treated in a less coherent way. Certain components are derived from experiment, others by Monte Carlo or other calculations, and in some instances where no reliable estimate can be made they are taken to be unity and an appropriate uncertainty included.

The values for $s_{w,air}$, W_{air} and p for ^{60}Co , high-energy photons, electrons, protons and heavy ions, and the resulting k_{Q,Q_0} factors and their uncertainties, are discussed in separate sections below. In estimating the uncertainty of k_{Q,Q_0} factors, correlations between the various parameters are taken into account in an approximate manner. For low- and medium-energy x-rays the Bragg-Gray cavity theory is not valid and so no calculated values for k_{Q,Q_0} are given in this Code of Practice for these radiation types.

In this Appendix the term “uncertainty” refers to the relative standard uncertainty expressed as a percentage.

B.2. ^{60}Co gamma radiation

As noted previously, when the reference quality Q_0 is ^{60}Co the symbol for k_{Q,Q_0} is simplified to k_Q . The factors $s_{w,air}$, W_{air} and p_Q for ^{60}Co appear in the denominator of k_Q for all radiation types and the values used are presented here.

B.2.1. Value for $s_{w,air}$ in ^{60}Co

The value $s_{w,air} = 1.133$ for ^{60}Co was calculated by Andreo *et al* [80] using the mono-energetic electron stopping-power data tabulated in ICRU Report 37 [66] with the density-effect correction due to Sternheimer. Uncertainties associated with the mean excitation energies (I -values) and density effect corrections give rise to a standard uncertainty of 0.5%, which does not include the basic uncertainty inherent in the stopping-power model. In addition, as a consequence of spectral differences between ^{60}Co beams, the uncertainty in assigning a stopping-power ratio to a particular ^{60}Co beam is estimated to be 0.1%.

B.2.2. Value for W_{air} in ^{60}Co

W_{air} is the mean energy expended in air per ion pair formed, more usually expressed in the form W_{air} / e . The value for W_{air} / e in ^{60}Co , for dry air, is taken to be 33.97 J C^{-1} [129-131]. The uncertainty of this value was estimated by Niatel *et al* [129] to be 0.2%.

B.2.3. Values for p_Q in ^{60}Co

The overall perturbation factor includes all departures from the behaviour of an ideal Bragg-Gray detector. In general, the contributing effects are small so that the individual perturbation factors p_i have values close to unity and can be treated independently. For cylindrical chamber types, the overall perturbation factor is obtained as the product

$$p_Q = p_{cav} p_{dis} p_{wall} p_{cel} \quad (\text{B.2})$$

The component perturbation factors p_{cav} , p_{dis} , p_{wall} and p_{cel} are defined in Section 1.6. For plane-parallel chamber types, p_{dis} and p_{cel} are omitted.

B.2.3.1. Values for p_{cav} in ^{60}Co

The cavity correction p_{cav} corrects for the perturbation of the electron fluence due to scattering differences between the air cavity and the medium. Since transient electronic equilibrium exists in ^{60}Co at z_{ref} (5 g cm^{-2} in water), the value for p_{cav} is taken to be unity (for both cylindrical and plane-parallel chamber types). The uncertainty associated with this assumption is negligible ($< 0.1\%$).

B.2.3.2. Values for p_{dis} in ^{60}Co

The displacement correction accounts for the fact that a cylindrical chamber cavity with its centre at z_{ref} samples the electron fluence at a point which is closer to the radiation source than z_{ref} . The correction depends on the inner radius of the cavity, r_{cyl} . Values derived from the measurements of Johansson *et al* [132] have been used;

$$p_{dis} = 1 - 0.004 r_{cyl} \quad (\text{B.3})$$

where r_{cyl} is in mm. The uncertainty of p_{dis} was estimated by Johansson *et al* [132] to be 0.3%. Plane-parallel chamber types are positioned with the front of the air cavity at z_{ref} and it is assumed that no displacement correction is necessary; the uncertainty in this assumption is estimated to be 0.2%.

B.2.3.3. Values for p_{wall} in ^{60}Co

The factor p_{wall} accounts for differences in the photon mass energy-absorption coefficients and electron stopping powers of the chamber wall material and the medium. For cylindrical chamber types, a thin plastic waterproofing sleeve is normally used to protect the chamber. The formulation developed by Almond and Svensson [133] and modified independently by Gillin *et al* [134] and Hanson and Dominguez-Tinoco [135] is used in this Code of Practice for the evaluation of p_{wall} , which includes the effect of the sleeve;

$$p_{wall} = \frac{\alpha s_{wall,air} (\mu_{en} / \rho)_{w,wall} + \tau s_{sleeve,air} (\mu_{en} / \rho)_{w,sleeve} + (1 - \alpha - \tau) s_{w,air}}{s_{w,air}} \quad (\text{B.4})$$

The values used assume a PMMA sleeve of thickness 0.5 mm. The values used for $s_{med,air}$ are those evaluated by Andreo *et al* [80] using the electron stopping-power data with Sternheimer density-effect corrections tabulated in ICRU Report 37 [66]. The ratios of photon mass energy-absorption coefficients are taken from Cunningham (see TRS-277 [17]). The values for α and τ are determined according to the expressions given in TRS-381 [21], i.e.,

$$\alpha(t_w) = 1 - e^{-11.88t_w} \quad (\text{B.4a})$$

and

$$\tau(t_s) = e^{-11.88t_w} (1 - e^{-11.88t_s}) \quad (\text{B.4b})$$

where t_w and t_s are, respectively, the thickness of the wall and the sleeve (in g cm^{-2}). These are based on the experimental data of Lempert *et al* [136] for which no uncertainty estimates were given. Andreo *et al* [80] compared the calculated ratios of p_{wall} for some materials with the experimental data of Johansson *et al* [132] and found agreement within 0.4%. Based on this, a combined standard uncertainty of 0.5% is estimated for p_{wall} .

This estimate applies also to plastic-walled chambers having a thin conductive layer or coating of graphite (“dag”). The effect of this coating on p_{wall} is difficult to estimate and both Monte Carlo calculations and experiments have so far failed to provide a satisfactory explanation of the underlying phenomena (see Ref. [137]). In addition, manufacturers do not generally provide information on the exact thickness of the coating, an exception being PTW (see footnote in Table 4.I). An alternative calculation of p_{wall} for the PTW-30001 chamber type has been made using Eq. (B.4), taking the 0.15 mm graphite coating (of density $\rho = 0.82 \text{ g cm}^{-3}$) to be the chamber wall and including the PMMA section of the wall as part of the waterproof sleeve. This results in a value for p_{wall} which is approximately 0.3% lower for ^{60}Co gamma-rays. However, approximately the same decrease is obtained for p_{wall} for high-energy photons, so that the effect of the graphite coating largely cancels in the ratio of p_{wall} values entering into the calculation of k_Q . These agree within 0.1% with the k_Q values obtained for this type of chamber under the assumption that the entire wall is made of PMMA (it is these latter values which are adopted for high-energy photons in the present Code of Practice). The contribution to the uncertainty of p_{wall} arising from this effect is considered to be negligible (<0.1%).

For plane-parallel chamber types, p_{wall} is problematic and variations of up to 3% between chambers of the same type have been reported [138]. It is for this reason that the cross-calibration method is included in Section 7. Nevertheless, values have been derived by a combination of measurement and calculation. Those given in TRS-381 [21] for a number of chamber types have been used. In addition, values for the Attix, Exradin and Holt chamber types have been taken from the calculations of Rogers [139], and for the Roos chamber from Palm *et al* [182]. By assuming that the 3% variations represent the 67% ($k=1$) confidence interval of a normal distribution, the standard uncertainty is estimated to be 1.5%.

B.2.3.4. Values for p_{cel} in ^{60}Co

For cylindrical chamber types, p_{cel} corrects for the lack of air equivalence of the central electrode. The correction for this effect is negligible for plastic and graphite central electrodes, as shown by the Monte Carlo calculations of Ma and Nahum [140] and the experimental determinations of Palm and Mattsson [141]. Both groups also showed that an aluminium central electrode of diameter 1 mm, as used in many Farmer-type chambers, increases the chamber response by around 0.7% at the reference depth in ^{60}Co . These findings were in good agreement with the increased response previously measured by Mattsson [142]. Thus a value for p_{cel} of 0.993 has been used here for chambers with an aluminium central electrode of 1 mm diameter. The uncertainty of the most recent measurements is 0.2% [141]. It is important to note that this value agrees with that used in TRS-277 [17], in which a value for $p_{cel-gbl}$ of unity was assumed for all cylindrical chamber types having a 1 mm diameter aluminium electrode as a result of the cancellation between the effect in air and in water measurements (see Appendix A).

B.2.4. Summary of values and uncertainties in ^{60}Co

Table B.I lists the values used for the factors p_{dis} , p_{wall} and p_{cel} and for the product $s_{w,air} p_Q$, for the cylindrical chamber types listed in Table 4.I. The uncertainty estimates as discussed above are summarized in Table B.II.

TABLE B.I. VALUES FOR THE FACTORS p_{dis} , p_{wall} AND p_{cel} AND FOR THE PRODUCT $s_{w,air} P_Q$ IN ^{60}Co GAMMA RADIATION, FOR VARIOUS CYLINDRICAL AND PLANE-PARALLEL IONIZATION CHAMBERS

(The value $s_{w,air} = 1.133$ is assumed, as noted in the text. For non waterproof cylindrical chambers the calculation of p_{wall} includes a 0.5 mm thick PMMA sleeve.)

Ionization chamber type ^a	p_{dis}	p_{wall}	p_{cel}	$s_{w,air} P_Q$
<i>Cylindrical chambers</i>				
Capintec PR-05P mini	0.992	0.977	1.000	1.098
Capintec PR-05 mini	0.992	0.977	1.000	1.098
Capintec PR-06C / G Farmer	0.987	0.989	1.000	1.107
Exradin A2 Spokas	0.981	0.978	1.000	1.088
Exradin T2 Spokas	0.981	1.013	1.000	1.127
Exradin A1 mini Shonka	0.992	0.978	1.000	1.100
Exradin T1 mini Shonka	0.992	1.013	1.000	1.139
Exradin A12 Farmer	0.988	0.984	1.000	1.101
Far West Tech IC-18	0.991	1.016	1.000	1.141
FZH TK 01	0.986	0.996	1.000	1.113
Nuclear Assoc 30-750	0.992	0.986	1.000	1.109
Nuclear Assoc 30-749	0.988	0.986	1.000	1.104
Nuclear Assoc 30-744	0.988	0.986	1.000	1.104
Nuclear Assoc 30-716	0.988	0.986	1.000	1.104
Nuclear Assoc 30-753 Farmer shortened	0.988	0.986	1.000	1.104
Nuclear Assoc 30-751 Farmer	0.988	0.997	0.993	1.108
Nuclear Assoc 30-752 Farmer	0.988	0.991	0.993	1.101
NE 2515	0.988	1.000	0.993	1.112
NE 2515/3	0.987	0.992	0.993	1.102
NE 2577	0.987	0.992	0.993	1.102
NE 2505 Farmer	0.988	1.000	0.993	1.112
NE 2505/A Farmer	0.988	1.012	0.993	1.126
NE 2505/3, 3A Farmer	0.987	0.992	0.993	1.102
NE 2505/3, 3B Farmer	0.987	1.009	0.993	1.122
NE 2571 Farmer	0.987	0.992	0.993	1.102
NE 2581 Farmer	0.987	1.007	1.000	1.127
NE 2561 / 2611 Sec Std	0.985	0.990	1.000	1.105
PTW 23323 micro	0.993	1.001	0.993	1.119
PTW 23331 rigid	0.984	1.001	0.993	1.109
PTW 23332 rigid	0.990	1.001	0.993	1.115
PTW 23333	0.988	1.001	0.993	1.113
PTW 30001/30010 Farmer	0.988	1.001	0.993	1.113
PTW 30002/30011 Farmer	0.988	0.991	1.000	1.109
PTW 30004/30012 Farmer	0.988	0.991	0.993	1.101
PTW 30006/30013 Farmer	0.988	1.001	0.993	1.112
PTW 31002 flexible	0.989	1.001	0.993	1.114
PTW 31003 flexible	0.989	1.001	0.993	1.114
SNC 100730 Farmer	0.986	1.001	0.993	1.111
SNC 100740 Farmer	0.986	0.990	0.993	1.099
Victoreen Radocon III 550	0.990	0.993	1.000	1.115
Victoreen Radocon II 555	0.990	1.010	1.000	1.134
Victoreen 30-348	0.990	1.001	1.000	1.123
Victoreen 30-351	0.988	1.001	1.000	1.121
Victoreen 30-349	0.984	1.001	1.000	1.116
Victoreen 30-361	0.990	1.001	1.000	1.124

Ionization chamber type ^a	P_{dis}	P_{wall}	P_{cel}	$s_{w,air} P_Q$
Wellhöfer IC 05	0.988	0.986	1.000	1.104
Wellhöfer IC 06	0.988	0.986	1.000	1.104
Wellhöfer IC 10	0.988	0.986	1.000	1.104
Wellhöfer IC 15	0.988	0.986	1.000	1.104
Wellhöfer IC 25	0.988	0.986	1.000	1.104
Wellhöfer IC 28 Farmer shortened	0.988	0.986	1.000	1.104
Wellhöfer IC 69 Farmer	0.988	0.997	0.993	1.108
Wellhöfer IC 70 Farmer	0.988	0.991	0.993	1.102
<i>Plane-parallel chambers</i>				
Attix RMI 449		1.023		1.159
Capintec PS-033		0.989		1.121
Exradin P11		1.018		1.154
Holt (Memorial)		1.004		1.138
NACP / Calcam		1.024		1.161
Markus		1.009		1.144
Roos		1.010		1.145

^a Some of the chambers listed in this table fail to meet some of the minimum requirements described in Section 4.2.1. However, they have been included in this table because of their current clinical use

TABLE B.II. ESTIMATED RELATIVE STANDARD UNCERTAINTIES OF THE PARAMETERS ENTERING INTO THE DENOMINATOR OF Eq. (B.1) AT THE ⁶⁰Co BEAM QUALITY

Component	Chamber type:	
	cylindrical u_c (%)	plane-parallel u_c (%)
$s_{w,air}$	0.5	0.5
Assignment of $s_{w,air}$ to beam quality	0.1	0.1
W_{air} / e	0.2	0.2
P_{cav}	<0.1	<0.1
P_{dis}	0.3	0.2
P_{wall}	0.5	1.5
P_{cel}	0.2	-
Combined standard uncertainty	0.8	1.6

B.3. High-energy photon beams

The individual parameters entering in the numerator of Eq. (B.1) for high-energy photon beams are discussed below. In estimating the uncertainties, correlations between the values for these parameters in ^{60}Co and in the high-energy photon beams are taken into account, since it is only ratios which enter into the k_Q factor.

B.3.1. Values for $s_{w,air}$ in high-energy photon beams

The Spencer-Attix stopping-power ratios $s_{w,air}$, are taken from the calculations of Andreo [143, 144]. These calculations were performed by using the electron stopping-power data tabulated in the ICRU Report 37 [66]. In estimating the uncertainty of $s_{w,air}$ relative to the ^{60}Co value, correlations are not large because the main effects are those arising from the uncertainty of the I -value for water, which is important for ^{60}Co but not for high energies, and the density effect model used for water, which is important only at higher energies. A value of 0.5% has been estimated. The uncertainty in assigning stopping-power ratios to a particular user beam quality is estimated to be 0.3%.

B.3.2. Value for W_{air} in high-energy photon beams

The value for W_{air} normally used for high-energy photon beams is the same as that used for ^{60}Co , and this practice is followed in the present Code of Practice. However, there is growing evidence [55] that this assumption could be in error by up to 1%. To account for this, an uncertainty component of 0.5% is assumed for the W_{air} ratio entering in Eq. (B.1).

B.3.3. Values for p_Q in high-energy photon beams

The components of the perturbation correction as given by Eq. (B.2) are discussed separately. Only cylindrical chamber types are considered, since plane-parallel chambers should not be used for reference dosimetry in high-energy photon beams.

B.3.3.1. Values for p_{cav} in high-energy photon beams

As in ^{60}Co , transient equilibrium is assumed to exist at the reference depth and the value for p_{cav} is taken to be unity with a negligible uncertainty (< 0.1%).

B.3.3.2. Values for p_{dis} in high-energy photon beams

In high-energy photon beams the displacement effect is one of the major contributions to the final uncertainty in k_Q . The only set of experimental data available is due to Johansson *et al* [132], with an estimated uncertainty of 0.3%. However, these values were determined mainly using accelerators of old design and at a time when beam qualities were specified in terms of ‘MV’. The values for this correction factor given by AAPM TG-21 [9] differ from the Johansson values by up to 0.6% for a Farmer type chamber, and even more for chambers of larger diameter, but these differences can be assumed to be consistent with the uncertainty estimate given above ⁴⁵. The values for ^{60}Co and for high-energy photons must be correlated, but the extent of this correlation is difficult to estimate. An estimate of the uncertainty of the p_{dis} ratio entering into the k_Q value is 0.5%.

B.3.3.3. Values for p_{wall} in high-energy photon beams

As for ^{60}Co , Eq. (B.4) is used for the calculation of p_{wall} , assuming a PMMA sleeve of thickness 0.5 mm. The use of this expression instead of the more common expression developed by Almond and Svensson [133] yields a maximum increase in p_{wall} of 0.2% for certain chamber types and beam qualities. The values for $s_{med,air}$ were evaluated by Andreo [143, 144] using the electron stopping-power data of ICRU Report 37 [66]. Values for the ratios of photon mass energy-absorption coefficients are taken from

⁴⁵ According to ISO [32] when there is no specific knowledge about the possible values of a variable X_i within an interval, one can only assume that the variable X_i lies within a uniform rectangular distribution with an expected value x_i in the midpoint of the interval and an associated variance $u^2(x_i)=a^2/3$, where a is the half-width of the interval.

Cunningham (see TRS-277 [17]). Since the same data and equation are used for p_{wall} in ^{60}Co and in high-energy photons, correlations are significant and the uncertainty in the p_{wall} ratio which enters into the k_Q value is estimated to be 0.5%.

B.3.3.4. Values for p_{cel} in high-energy photon beams

The Monte Carlo calculations of Ma and Nahum [140] and the experimental determinations of Palm and Mattsson [141] showed that a plastic or graphite central electrode of 1 mm diameter has no effect on the response of an ionization chamber in a water phantom irradiated by high-energy photons. However, the presence of an aluminium electrode of diameter 1 mm increases the response by 0.43% to 0.75% for photon beam qualities $TPR_{20,10}$ of 0.80 and 0.58 respectively. These results, assumed to vary linearly with the beam quality, have been used for the calculation of k_Q . The experimental uncertainty of p_{cel} is estimated to be 0.2%. However, there will be some correlation in the p_{cel} values for ^{60}Co and for high-energy photons and the uncertainty in the ratio of p_{cel} factors is estimated to be 0.1%.

B.3.4. Summary of uncertainties in high-energy photon beams

Table B.III summarizes the estimates of the standard uncertainties for all of the parameters entering into Eq. (B.1). For high-energy photon beams the combined standard uncertainty in the values for k_Q is 1.0%.

TABLE B.III. ESTIMATED RELATIVE STANDARD UNCERTAINTY OF THE CALCULATED VALUES FOR k_Q FOR HIGH-ENERGY PHOTON BEAMS

Component	u_c (%)
$s_{w,air}$ relative to ^{60}Co	0.5
Assignment of $s_{w,air}$ to beam quality	0.2
W_{air}/e relative to ^{60}Co	0.3
p_{cav} in ^{60}Co and in high-energy photons	<0.1
p_{dis} relative to ^{60}Co	0.4
p_{wall} relative to ^{60}Co	0.5
p_{cel} relative to ^{60}Co	0.1
Combined standard uncertainty in k	1.0

It is worth pointing out that the estimated uncertainties given in Table B.III take into account, in an approximate manner, limitations in our current knowledge of ionization chamber perturbation correction factors in photon beams. For example, it has been shown by Seuntjens *et al* [145] that, when the effect of the waterproof sleeve is neglected in the calculation of p_{wall} (as in the American protocol TG-51 [51]), a slightly better agreement between experimental and calculated k_Q values is obtained for some ionization chambers at high photon beam energies. The magnitude of this effect is shown in Fig. B.1 for k_Q values calculated as a function of $TPR_{20,10}$ for two commonly-used types of ionization chamber. A small, progressive decrease in the values for k_Q at high energies can be seen when PMMA sleeves of thickness 1 mm, 0.5 mm and no sleeve at all are used in the calculation of p_{wall} . The net effect is a gradual improvement in the agreement with k_Q values determined experimentally. It should be emphasized, however, that a similar trend could be obtained by the use of values for the perturbation correction factors p_{cav} , p_{dis} and p_{cel} which differ from those used in the present Code of Practice. Neglecting the effect of the sleeve, or any other component, in the calculation of p_{wall} should not be justified on the grounds of an improved agreement with experimental k_Q values. The calculated values used in this Code of Practice for all chamber perturbation correction factors are those considered to be the best choice according to the state of the art of ionization chamber dosimetry. It is emphasized once again, however, that the preferred choice in this Code of Practice is the use of experimentally-determined values for the user chamber.

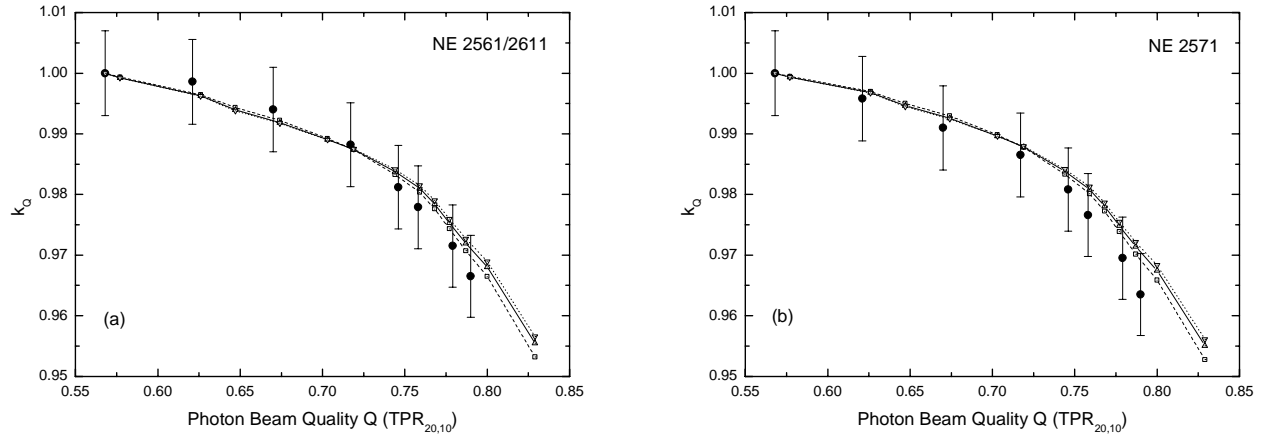

Fig. B.1. Comparison of experimental and calculated k_Q values for high-energy photon beams, where the influence of PMMA waterproof sleeves of different thicknesses in the calculation of the p_{wall} correction factors is shown for the chamber types NE2561/2611 and NE2571. The experimental values (filled circles) were measured at the NPL [60], for which an uncertainty of 0.7% has been estimated (see footnote c in Table 6.IV). The sleeve thicknesses are 1 mm (dotted lines, inverted triangles), 0.5 mm (solid lines, upright triangles) and no sleeve (dashed lines, squares).

B.4. Electron beams

For electron dosimetry, the evaluation of k_{Q,Q_0} depends on whether the calibration quality Q_0 is ^{60}Co or an electron beam. In the former case, k_Q is evaluated as for the other radiation types, taking the ^{60}Co values from Section B.2. In the latter case, $k_{Q,Q_{int}}$ and $k_{Q_0,Q_{int}}$ are introduced, but the factors (and uncertainties) contained in Q_{int} cancel when the ratio of these is taken and so the choice of Q_{int} is irrelevant to the present discussion.

B.4.1. Values for $s_{w,air}$ in electron beams

Stopping-power ratios $s_{w,air}$ were calculated by Ding *et al* [92] using Monte Carlo simulations which included details of the accelerator heads of clinical linear accelerators for a variety of accelerator types. The basic mono-energetic data were those of ICRU Report 37 [66]. The ratios calculated at z_{ref} (as given by Eq. (7.2)) were empirically fitted by Burns *et al* [91] and it is these fitted values which are used in the present Code of Practice. The stopping-power ratio at z_{ref} in an electron beam of quality R_{50} is given by

$$s_{w,air}(z_{ref}) = 1.253 - 0.1487(R_{50})^{0.214} \quad (R_{50} \text{ in } \text{g cm}^{-2}) \quad (\text{B.5})$$

This relation is valid over the R_{50} range from 1 g cm^{-2} to 20 g cm^{-2} . The standard deviation of the fitted values is 0.16% which indicates that the values for $s_{w,air}$ at z_{ref} for different accelerators are not very different.

Estimation of the uncertainty follows the discussion of Section B.3 in relation to correlations. When Q_0 is ^{60}Co , a standard uncertainty of 0.5% is appropriate for all electron beam qualities. For calibration in an electron beam, this uncertainty is reduced to 0.2%. The applicability to a particular accelerator of stopping powers given by Eq. (B.5) was estimated by Burns *et al* [91] to be less than 0.2%.

For depths other than z_{ref} , the same basic data were fitted with an equation of the form

$$s_{w,air}(z) = \frac{a + bx + cx^2 + dy}{1 + ex + fx^2 + gx^3 + hy} \quad (\text{B.6})$$

where $x = \ln(R_{50})$ and $y = z / R_{50}$ is the relative depth. The values for the constants are

$$\begin{array}{llll}
a = 1.075 & b = -0.5087 & c = 0.0887 & d = -0.084 \\
e = -0.4281 & f = 0.0646 & g = 0.00309 & h = -0.125
\end{array}$$

The standard deviation of the fit is 0.4%. Values derived using this equation are given in Table 7.V for a series of values of R_{50} in the range from 1 g cm⁻² to 20 g cm⁻² and for values of the relative depth z / R_{50} in the range from 0.02 to 1.2.

B.4.2. Value for W_{air} in electron beams

As for high-energy photons, the value for W_{air}/e for dry air is taken to be 33.97 J C⁻¹ and an uncertainty of 0.5% is included to account for a possible variation in this value with electron energy. For calibration in a high-energy electron beam and use in a low-energy beam, the uncertainty is smaller and a value of 0.3% is estimated.

B.4.3. Values for p_Q in electron beams

Perturbation factors in electron beams are discussed extensively in TRS-381 [21] and most of the values recommended therein are adopted in the present Code of Practice. The various components are as given in Eq. (B.2). Correlations between the uncertainties for ⁶⁰Co and electron beams are assumed to be negligible. For calibration in a high-energy electron beam and use in a low-energy beam, the uncertainty in the ratio of p_Q factors is taken to be the same as that in p_Q itself for the low energy.

Note that several data sets for perturbation factors previously expressed in terms of E_z , the mean energy at depth z , have been re-cast here in terms of R_{50} . For older data, where E_z was calculated using the equation due to Harder [146], p_Q data were re-cast using Eq. (7.2) for z_{ref} and the equations

$$E_{z_{ref}} = E_o \left(1 - \frac{z_{ref}}{R_p} \right)$$

$$E_o = 2.33 R_{50} \tag{B.7}$$

$$R_p = 1.271R_{50} - 0.23$$

(all depths expressed in g cm⁻²) where E_o is the mean energy at the phantom surface and R_p is the practical range in water. The first two relations have been widely used. The third is taken from Rogers [147] and is derived from Monte Carlo simulations using realistic clinical spectra. The resulting relation, obtained graphically, is

$$E_{z_{ref}} = 1.23 R_{50} \tag{B.8}$$

Note that this equation is subject to the same limitations as the Harder equation [148]. For more recent data for which improved E_z values were derived using TRS-277 [17], the data were re-cast using

$$E_{z_{ref}} = 0.07 + 1.027 R_{50} - 0.0048 (R_{50})^2 \tag{B.9}$$

which is a fit to the data in TRS-277 [17] and TRS-381 [21] at the reference depths given by Eq. (7.2).

Note that perturbation factors expressed in terms of E_z are normally determined close to the dose maximum, but it is assumed here that they also apply at z_{ref} . At low energies, where z_{ref} coincides with the dose maximum, this is a good assumption. At higher energies it may not be so good, but in this regime perturbation factors are small and vary slowly with depth so that the approximation should be sufficiently good. Nevertheless, measurements of perturbation factors at z_{ref} are to be encouraged; experimental work by Huq *et al* [149] has verified the above assumption for the Farmer cylindrical chamber type.

B.4.3.1. Values for p_{cav} in electron beams

For plane-parallel chamber types which are considered to be ‘well-guarded’, that is, having a radial guard area around the collecting volume of at least 1.5 times the electrode spacing, p_{cav} at z_{ref} is assumed to be unity (with a negligible uncertainty).

For a cylindrical chamber of internal radius r_{cyl} , the p_{cav} data of Refs.[17, 21, 132] have been re-cast in terms of R_{50} and fitted with the equation

$$p_{cav} = 1 - 0.0217 r_{cyl} \exp(-0.15 R_{50}) \quad (r_{cyl} \text{ in mm, } R_{50} \text{ in g cm}^{-2}) \quad (\text{B.10})$$

which is valid (at z_{ref}) for r_{cyl} in the range from 1.5 mm to 3.5 mm. For beam qualities just above $R_{50} = 4 \text{ g cm}^{-2}$, for which cylindrical chambers may be used, the cavity correction for most chamber types is less than 3% and an uncertainty of 0.5% is estimated.

B.4.3.2. Values for p_{dis} in electron beams

In this Code of Practice, all chambers are positioned in electron beams so as to minimize the displacement effect and no explicit correction is applied. For plane-parallel chamber types, the uncertainty in this procedure is estimated to be less than 0.2% and for cylindrical chamber types an uncertainty of 0.3% is assumed.

B.4.3.3. Values for p_{wall} in electron beams

For plane-parallel chamber types, wall effects in electron beams are discussed in detail in TRS-381 [21]; some more recent relative measurements are given by Williams *et al* [150]. In summary, despite evidence that backscatter differences between the rear chamber wall and water may introduce a non-negligible p_{wall} , there are at present insufficient data to recommend explicit values and so p_{wall} is taken to be unity. The uncertainty associated with this assumption is difficult to estimate. The most likely explanation for the observed results is that the graphite rear wall of the NACP chamber type backscatters much like water (within 0.2%) and that the thin PMMA rear wall of the Roos chamber type gives rise to the small backscatter deficiency (less than 0.2%) hinted at in measurements relative to the NACP chamber type. An uncertainty of p_{wall} for well-guarded chamber types of 0.3% at low energies is consistent with this explanation.

For cylindrical chambers the p_{wall} component in electron beams is generally considered to be small (c.f. [151]) and in the present Code of Practice it is taken as unity. The uncertainty of this assumption is estimated to be 0.5%.

B.4.3.4. Values for p_{cel} in electron beams

For cylindrical chambers p_{cel} must be considered for chambers which have an aluminium central electrode. The calculations of Ma and Nahum [140] and the experimental determinations of Palm and Mattsson [141] show that, for a Farmer-type chamber with an aluminium electrode of diameter 1 mm, a value of around 0.998 can be used for all energies. A standard uncertainty of 0.1% is assumed.

B.4.3.5. Measured values for p_Q for certain chamber types in electron beams

Three plane-parallel chamber types known to have insufficient guarding are included because of their widespread use. Data for the PTW Markus chamber M23343 and the Capintec PS-033 are given in TRS-381 [21]. When re-cast in terms of R_{50} , these data can be represented by

$$p_{\text{Markus}, R_{50}} = 1 - 0.037 \exp(-0.27 R_{50}) \quad (R_{50} \geq 2 \text{ g cm}^{-2}) \quad (\text{B.11})$$

and

$$p_{\text{Capintec}, R_{50}} = 1 - 0.084 \exp(-0.32 R_{50}) \quad (R_{50} \geq 2 \text{ g cm}^{-2}) \quad (\text{B.12})$$

Note the lower limits of validity of these equations and that both data sets apply only at z_{ref} . For all chamber types, the values given were determined by relative measurements against a well-guarded chamber type whose perturbation correction was assumed to be unity. The standard uncertainty of the fitted values, which represent the total perturbation correction p_Q , is less than 0.2%. However, the overall uncertainty is limited by the uncertainty of p_{wall} for the well-guarded chamber type, which is 0.3%.

B.4.4. Summary of uncertainties in electron beams

Table B.IV summarizes the estimates of the standard uncertainties for all of the parameters entering into Eq. (B.1) for the case when Q_0 is ^{60}Co . The combined standard uncertainty in the values for k_Q is 1.2% for cylindrical chamber types and 1.7% for plane-parallel chamber types, the latter dominated by p_{wall} in ^{60}Co . Table B.V gives the uncertainties for the case when Q_0 is a high-energy electron beam (note that R_{50} must not be less than 4 g cm^{-2} when a cylindrical chamber is used). The uncertainties are significantly lower than those for calibration in ^{60}Co , particularly for plane-parallel chamber types due to the avoidance of p_{wall} in ^{60}Co .

TABLE B.IV. ESTIMATED RELATIVE STANDARD UNCERTAINTY OF THE CALCULATED VALUES FOR k_Q FOR ELECTRON BEAMS (BASED ON THE CALIBRATION QUALITY ^{60}Co)

Component	Chamber type: cylindrical		Chamber type: plane-parallel	
	Beam quality range:		Beam quality range:	
	Electrons $R_{50} \geq 4 \text{ g cm}^{-2}$ u_c (%)	^{60}Co +electrons $R_{50} \geq 4 \text{ g cm}^{-2}$ u_c (%)	Electrons $R_{50} \geq 1 \text{ g cm}^{-2}$ u_c (%)	^{60}Co +electrons $R_{50} \geq 1 \text{ g cm}^{-2}$ u_c (%)
$s_{w,air}$ relative to ^{60}Co	-	0.5	-	0.5
Assignment of $s_{w,air}$ to beam quality		0.2		0.2
W_{air} / e relative to ^{60}Co	-	0.5	-	0.5
p_{cav}	0.5	0.5	< 0.1	< 0.1
p_{dis}	0.3	0.4	0.2	0.3
p_{wall}	0.5	0.7	0.3	1.5
p_{cel}	0.1	0.2	-	-
Combined standard uncertainty in k_Q	-	1.2	-	1.7

TABLE B.V. ESTIMATED RELATIVE STANDARD UNCERTAINTIES OF THE CALCULATED VALUES FOR k_{Q,Q_0} IN AN ELECTRON BEAM (BASED ON CALIBRATION IN A HIGH-ENERGY ELECTRON BEAM)

Component	Chamber type:	cylindrical	plane-parallel
	Beam quality range	$R_{50} \geq 4 \text{ g cm}^{-2}$	$R_{50} \geq 1 \text{ g cm}^{-2}$
		u_c (%)	u_c (%)
$s_{w,air}$ relative to high-energy beam		0.2	0.2
Assignment of $s_{w,air}$ to beam quality		0.3	0.3
W_{air} / e relative to high-energy beam		0.3	0.3
p_{cav} relative to high-energy beam		0.5	0
p_{dis} relative to high-energy beam		0.3	0.2
p_{wall} relative to high-energy beam		0.5	0.3
p_{cel} relative to high-energy beam		0.1	-
Combined standard uncertainty in k_{Q,Q_0}		0.9	0.6

B.5. Proton beams

For proton dosimetry, the calculated beam quality correction factors given in the present Code of Practice are based on calibration in ^{60}Co . The values used for the denominator of Eq. (B.1) are discussed in Section B.2.

B.5.1. Values for $s_{w,air}$ in proton beams

The values used are derived from the proton beam quality specifier R_{res}

$$s_{w,air} = a + b R_{res} + \frac{c}{R_{res}} \quad (\text{B.13})$$

where $a = 1.137$, $b = -4.3\text{E-}05$ and $c = 1.84 \text{ E-}03$.

This equation is obtained as a fit to the mono-energetic stopping-power ratios calculated using the Monte Carlo code PETRA [152]. The basic proton stopping powers are taken from ICRU Report 49 [118]. The PETRA stopping-power ratios include the transport of secondary electrons and nuclear inelastic processes which is not the case for the ICRU stopping powers. PETRA calculates stopping-power ratios 'in-line', that is, during the transport of the particles, following the Spencer-Attix cavity theory. In-line calculation has the advantage of exact scoring of the tracks-ends. In addition, any possible influence on the result of the number and size of the energy scoring bins is avoided.

The resulting ratios are at most 0.6% higher than the corresponding ICRU values. At the reference depth (as given in Table 10.II) the difference between the PETRA and the ICRU calculated values is smaller (between 0.2% and 0.4% depending on depth, energy and SOBP width) and is well within the stated uncertainties. The statistical uncertainty of $s_{w,air}$ is estimated to be 0.2% [153]. The uncertainty of the stopping-power ratios at the reference depth in a clinical beam is estimated to be 1%. Figure B.2 shows $s_{w,air}$ as a function of R_{res} . No correlation with electron stopping powers is assumed in evaluating the uncertainty of k_Q factors. The uncertainty of assigning stopping-power ratios to a given proton beam quality is estimated to be 0.3%.

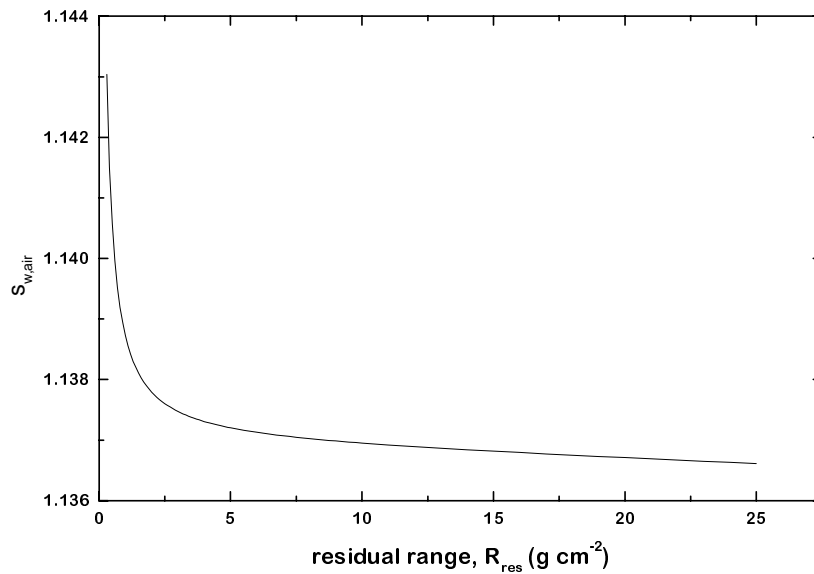

Fig. B.2. Spencer-Attix ($\Delta=10 \text{ keV}$) stopping-power ratios, water to air, for clinical proton beams as a function of the beam quality index R_{res} . The curve is a fit to mono-energetic stopping-power ratios calculated by Medin and Andreo using the Monte-Carlo code PETRA [152, 153]. The data include the transport of secondary electrons and nuclear inelastic processes, and the basic proton stopping-powers are taken from ICRU Report 49 [118].

B.5.2. Value for W_{air} in proton beams

A comprehensive review of the literature on the value for $W_{air}(E)$, including values obtained from the comparison of calorimetric and ionometric methods, is presented in ICRU Report 59 [116]. Moreover, the report presents an extensive discussion on the difference between $W_g(E)$, the mean energy required for charged particles of energy E to create an electron-ion pair in a gas g , and $w_g(E)$, the differential value. Since in the present Code of Practice the PETRA stopping-power ratios are recommended, the values for $W_{air}(E)$ given in the ICRU Report (namely those obtained from comparisons of calorimetric and ionometric measurements) must be corrected to account for the small differences between the PETRA and ICRU stopping-power ratios. A procedure using weighted medians, taking into account the statistical uncertainty of each value [154, 155], yields the value $W_{air/e} = 34.23 \text{ J C}^{-1}$ with a standard uncertainty of 0.4%. This uncertainty can be compared with the uncertainty of 0.2% for the $W_{air/e}$ value for electrons, which was obtained by the same statistical method ⁴⁶.

Until more information is available, the value $W_{air/e} = 34.23 \text{ J.C}^{-1}$ and a standard uncertainty of 0.4% are recommended for proton dosimetry and these values are used in the present Code of Practice.

B.5.3. Values for p_Q in proton beams

Experimental information on perturbation factors in proton beams is currently only available for a limited number of ionization chambers at a specific proton energy. Therefore all components are taken to be unity. The discussion below concentrates on the uncertainties.

B.5.3.1. Values for p_{cav} in proton beams

The uncertainty of p_{cav} may be considered in two parts, corresponding to the contributions of secondary electrons and of heavier secondary particles. The slowing down of the secondary electrons generated in a proton beam is similar to that for photons (⁶⁰Co or high-energy photons) and so the negligible uncertainty assumed for the photon case may also be assumed for protons. The uncertainty of the heavier particle contribution is taken to be 0.3%, for both plane-parallel and cylindrical chambers.

B.5.3.2. Values for p_{dis} in proton beams

Since the reference depth (as given in Table 10.II) is situated in a uniform dose region, p_{dis} is taken to be unity. The magnitude of the correction is unlikely to exceed 0.5%. This includes the effect of possible ripples in the SOBP and a small dose gradient in the plateau region. It should be stressed that this effect might depend on the resolution of the modulation, influencing the dose uniformity in the SOBP. An uncertainty of 0.2% is estimated for this correction, for both plane-parallel and cylindrical chambers.

B.5.3.3. Values for p_{wall} in proton beams

Monte Carlo calculations by Palmans and Verhaegen [117] indicate a possible effect on p_{wall} due to the influence of secondary electrons. Recent measurements [157] confirmed these calculations for certain wall materials, however the effect would not be larger than 0.5%. Therefore p_{wall} is currently taken to be equal to unity. In estimating the uncertainty, a similar argument to that for p_{cav} may be applied to p_{wall} , namely, that the uncertainty arising from the secondary electron component should be similar to that for photons, which is 0.5%. Likewise, a heavy particle contribution of 0.3% is assumed. A component of 0.2% arising from the primary protons is also included, giving a combined uncertainty of 0.6%, for both plane-parallel and cylindrical chambers.

B.5.3.4. Values for p_{cel} in proton beams

For chamber types with an aluminium central electrode, a value for p_{cel} of 0.997 was reported by Medin *et al* [54] for a 170 MeV proton beam and of 1.00 by Palmans *et al* [157] in a 75 MeV proton beam. The

⁴⁶ It is possible to arrive at the same average value using a simple “robust fit”, which minimizes the influence of outliers (see Ref. [156]), but the procedure given in this reference does not allow statistical weights to be taken into account in determining the uncertainty.

value 1.0 is used in the present Code of Practice along with their stated uncertainty of 0.4%, which is adopted for all cylindrical ionization chambers.

B.5.4. Summary of uncertainties in proton beams

Table B.VI summarizes the uncertainty estimates and shows a combined standard uncertainty in k_Q for proton beams of 1.7% and 2.1% for cylindrical and plane-parallel ionization chambers respectively. The largest component of this uncertainty is the uncertainty of $s_{w,air}$ and the uncertainty of p_{wall} for plane-parallel ionization chambers in the ^{60}Co reference beam.

TABLE B.VI. ESTIMATED RELATIVE STANDARD UNCERTAINTY OF THE CALCULATED VALUES FOR k_Q FOR PROTON BEAMS

Component	cylindrical		plane-parallel	
	protons u_c (%)	^{60}Co +protons u_c (%)	protons u_c (%)	^{60}Co +protons u_c (%)
$s_{w,air}$	1.0	1.1	1.0	1.1
Assignment of $s_{w,air}$ to beam quality	0.3	0.4	0.3	0.4
W_{air}/e	0.4	0.5	0.4	0.5
p_{cav}	0.3	0.3	0.3	0.3
p_{dis}	0.2	0.4	0.2	0.3
p_{wall}	0.6	0.8	0.6	1.6
p_{cel}	0.4	0.5	-	-
Combined standard uncertainty in k_Q	-	1.7	-	2.1

B.6. Heavy-ion beams

For heavy-ion beams, the calculated beam quality correction factors given in the present Code of Practice are based on calibration in ^{60}Co . Thus the values used for the denominator of Eq. (B.1) are discussed in Section B.2.

B.6.1. Value for $s_{w,air}$ in heavy-ion beams

The value for $s_{w,air}$ should be obtained by averaging over the complete spectrum of primary particles and fragmented nuclei at the reference depth, as

$$s_{w,air} = \frac{\sum_i \int_0^\infty \Phi_{E,i} \cdot (S_i(E)/\rho)_w dE}{\sum_i \int_0^\infty \Phi_{E,i} \cdot (S_i(E)/\rho)_{air} dE} \quad (\text{B.14})$$

where $(S_i(E)/\rho)_m$ is the mass stopping power at energy E for particle i in medium m and Φ_E is the particle fluence differential in energy. However, in view of the lack of knowledge of the fluence spectra Φ_E , substantial simplifications must be made.

Fig. B.3 shows calculated values for $s_{w,air}$ using several computer codes developed by Salamon [158] for helium, carbon, neon and argon ions, by Hiraoka and Bichsel [159] for carbon ions, and by ICRU for protons and helium. As can be seen from this figure, all values lie in the range from 1.12 to 1.14, including the values for slow heavy ions. At present, a constant value of 1.13 is adopted for the value of $s_{w,air}$ in heavy-ion beams. The uncertainty of $s_{w,air}$ in heavy-ion beams should be much larger than that in proton beams because of its dependence on energy and particle type. Uncertainties in the basic stopping-powers must also be included. A combined standard uncertainty of 2.0% has been estimated [123] which is adopted here.

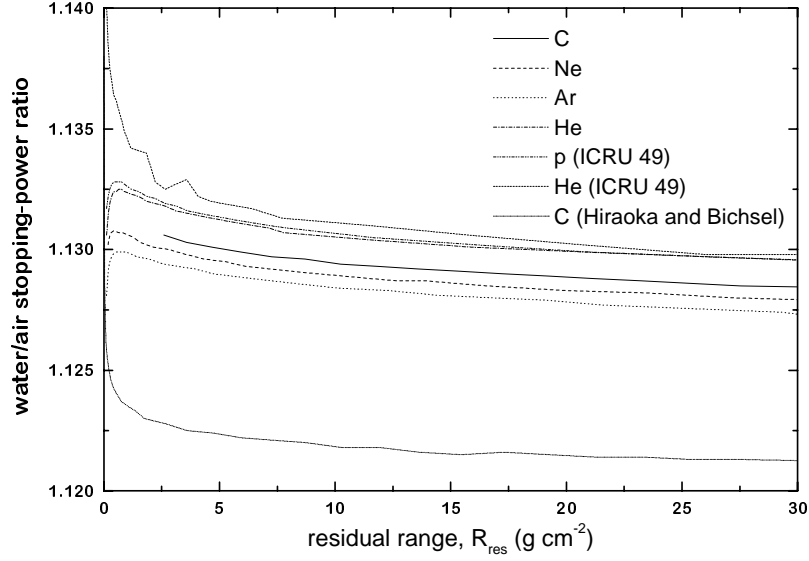

Fig. B.3. Stopping-power ratio water to air for heavy ions calculated using the computer codes developed by Salamon [158] (for C, Ne, Ar and He) and by Hiraoka and Bichsel [159] (for C). Data for protons and He given by ICRU 49 [118] are also included.

B.6.2. Value for W_{air} in heavy-ion beams

As discussed above for $s_{w,air}$, the value for W_{air} should ideally be obtained by averaging over the complete spectrum of primary particles and fragmented nuclei at the reference depth;

$$\left(\frac{w}{e}\right)_{HI} = \frac{\sum_i \int_0^{\infty} \Phi_{E,i} \cdot (S_i(E) / \rho)_{air} dE}{\sum_i \int_0^{\infty} \frac{\Phi_{E,i} \cdot (S_i(E) / \rho)_{air}}{w_i(E) / e} dE} \quad (B.15)$$

where $w_i(E)$ is the differential value of W_{air} at energy E for particle i . The fluence differential in energy, Φ_E , should cover a wide energy spectrum and include all primary and secondary particles.

There have been only a few experimental investigations of W_{air} for high-energy heavy ions. Hartmann [123] analysed the W_{air} value for high-energy carbon ions and concluded that the value $34.8 \text{ J}\cdot\text{C}^{-1}$ should be used. In the present code, W_{air} values for different ions were taken from the literature and are given in table B.VII. The same procedure as applied for the proton beams, taking into account the statistical uncertainty of each value [154, 155], results in a value for $W_{air}/e = 34.50 \text{ J}\cdot\text{C}^{-1}$ with a standard uncertainty of 1.5%.

Until more information is available, the value $W_{air}/e = 34.50 \text{ J}\cdot\text{C}^{-1}$ and a standard uncertainty of 1.5% are recommended for heavy-ion beam dosimetry and these values are used in the present Code of Practice.

TABLE B.VII. EXPERIMENTAL VALUES FOR W_{air}/e FOR VARIOUS IONS AT DIFFERENT ENERGIES

Ion	W_{air}/e (J C ⁻¹)	Energy (MeV/u)	Reference
³ He	34.5	10.3	[160]
³ He	35.7	31.67	[161]
¹² C	36.2	6.7	[160]
¹² C	33.7	129.4	[160]
¹² C	35.28	250	[162]
¹² C	35.09	250	[163]
²⁰ Ne	34.13	375	[163]
⁴⁰ Ar	33.45	479	[163]
Ions with Z between 9 and 14	31.81	170	[164]
W_{air}/e (weighted median) = 34.50 J C ⁻¹ ± 1.5%			

B.6.3. Value for p_Q in heavy-ion beams

At present, no experimental information is available on perturbation factors in heavy ions and all components are taken to be unity. An overall uncertainty of 1.0% is assumed, based on the evaluation of Hartmann *et al.* [123].

B.6.4. Summary of uncertainties in heavy-ion beams

Table B.VIII summarises the uncertainty estimates and shows a combined standard uncertainty in k_Q in heavy-ion beams of 2.8% and 3.2% for the cylindrical and plane-parallel chambers respectively. This arises largely from the uncertainty of the stopping-power ratio $s_{w,air}$ and the value for W_{air} .

TABLE B.VIII. ESTIMATED RELATIVE STANDARD UNCERTAINTY OF THE CALCULATED VALUES FOR k_Q FOR HEAVY IONS

Component	heavy ions	⁶⁰ Co+heavy ions	heavy ions	⁶⁰ Co+heavy ions
	cylindrical chambers		plane-parallel chambers	
	u_c (%)	u_c (%)	u_c (%)	u_c (%)
$s_{w,air}$	2.0	2.1	2.0	2.1
W_{air}/e	1.5	1.5	1.5	1.5
p (combined)	1.0	1.0	1.0	1.8
Combined standard uncertainty in k_Q	-	2.8	-	3.2

APPENDIX C. PHOTON BEAM QUALITY SPECIFICATION ⁴⁷

The specification of the quality of a photon beam has been the subject of numerous studies due to its relevance in radiation dosimetry. However, no beam quality specifier has been found that satisfies all possible requirements of being a unique specifier for the entire energy range of photon energies used in radiotherapy and all possible accelerators used in hospitals and standards laboratories. Discussions raised in this context are described in this Appendix in order to provide a reasoned discussion of the advantages and disadvantages of using $TPR_{20,10}$ versus other specifiers, specifically $PDD(10)_x$ proposed by Kosunen and Rogers [165] and used in the dosimetry protocol of the AAPM TG-51 [51]. For completeness, an overview of common photon beam quality specifiers used in radiotherapy dosimetry is given here based on the description provided by the ICRU Report on the dosimetry of high-energy photon beams based on standards of absorbed dose to water [29].

C.1. Overview of common photon beam quality specifiers

Most dosimetry protocols, based on both standards of air kerma and standards of absorbed dose to water, have recommended the Tissue-Phantom Ratio, $TPR_{20,10}$, as specifier of the quality of a high-energy photon beam [9, 12-14, 17, 19, 49, 50]. $TPR_{20,10}$ is defined as the ratio of water absorbed doses on the beam axis at the depths of 20 cm and 10 cm in a water phantom, obtained with a constant source-detector distance (SDD) of 100 cm and a 10 cm x 10 cm field size at the position of the detector. The parameter $TPR_{20,10}$ is a measure of the effective attenuation coefficient describing the approximately exponential decrease of a photon depth-dose curve beyond the depth of maximum dose [82-84], and more importantly, it is independent of the electron contamination in the incident beam.

Prior to the use of dose ratios for specifying photon beam quality, the nominal accelerator potential was the parameter most commonly used in photon beam dosimetry. Measured ionization (charge or current) or absorbed-dose ratios were first used as a beam quality index in the dosimetry recommendations of the Nordic Association of Clinical Physicists (NACP) [8, 166]. The measured ratio in a clinical treatment unit was, however, associated with a generic nominal accelerator energy (nominal accelerating potential or nominal maximum energy, expressed in MV), which was then used for the selection of conversion factors. A first attempt at improving the NACP procedure was made in the AAPM TG-21 protocol [9]. Data in TG-21 for stopping-power ratios, mass energy-absorption coefficient ratios, etc., were still given numerically as a function of the nominal MV, but these data were associated in graphical form with measured ionization ratios. There were, however, two limitations in the TG-21 method: (i) the relation between measured and calculated ionization ratios was based on inaccurate calculations, and (ii) the graphical procedure also involved a unique correspondence between MV and ionization ratios, similar to the drawback pointed out for the NACP recommendations [8, 166]. Andreo and Brahme [78] showed that the use of only the nominal accelerator potential, ignoring the actual penetration properties of a clinical beam, could yield variations of up to 1.5% in the stopping-power ratio. It is mainly for this reason that the use of $TPR_{20,10}$ was considered to be the more appropriate choice for radiotherapy beams, rather than using the nominal accelerating potential.

Other beam quality specifiers have been proposed for photon beam dosimetry which are, in most cases, related to the depth of maximum absorbed dose and can, therefore, be affected by the electron contamination at this depth. In addition, the use of ionization distributions measured with thimble-type ionization chambers is problematic, as the displacement of phantom material by the detector has to be taken into account to convert ionization into dose distributions. This is avoided if plane-parallel ionization chambers are used, but these are not commonly used in photon beam dosimetry.

⁴⁷ Part of the content of this Appendix has been adopted from ref. [85] and is reproduced here with permission from the American Association of Physicists in Medicine.

Based on percentage depth-dose distributions, a widely disseminated recommendation for specifying the quality of high-energy photon beams was made in Supplement 17 of the British Journal of Radiology [87]. BJR-17 defined the parameter d_{80} as the depth of the 80% depth-dose (i.e. 80% of the dose maximum) for a 10 cm x 10 cm field size at an SSD of 100 cm. In BJR-17 it was pointed out that electron contamination should be considered a practical shortcoming of the method. The use of d_{80} as a photon beam quality index has also been endorsed in Supplement 25 of the British Journal of Radiology [81], although other beam quality specifiers, like $PDD(10)$ below are also considered. In its conclusions, BJR-25 also referred to contaminating electrons as the greatest problem for normalization at z_{max} , as by changing the dose at this depth electron contamination can alter the apparent beam quality. It is interesting to note that even since Supplement 11 of the British Journal of Radiology [167], the problem of electron contamination and the need to normalize dose-distributions at depths larger than z_{max} has been addressed by different BJR Supplements, but alternatives for a specifier independent of electron contamination have not been proposed in this series of publications.

The parameter $PDD(10)$, the percentage depth-dose at 10 cm depth, determined under the same conditions of field size and SSD as d_{80} , has the same limitation with regard to the effect of electron contamination as d_{80} . This parameter has been commonly used by accelerator manufacturers, associating it with an *effective accelerator potential*. The work by LaRiviere [168], proposing a relation between the beam quality specified in terms of MV and $PDD(10)$, has been used by manufacturers to justify the use of this parameter. This has, however, produced the paradoxical situation where an accelerator could have an *effective MV* larger than the accelerator electron energy.

LaRiviere [168] also proposed a relation between $PDD(10)$ and the dose-weighted mean energy of the photon spectrum, which was suggested as an alternative beam quality index. That proposal led Kosunen and Rogers [165] to investigate the relation of $PDD(10)_x$ in a “*pure photon beam*” (i.e., without electron contamination) to stopping-power ratios. Based on the linearity of the relation obtained, they proposed extending the use of $PDD(10)_x$ to specify the quality of photon beams and to select conversion and correction factors. Kosunen and Rogers referred to the problem of the difference between absorbed-dose and ionization measurements with cylindrical ionization chambers due to the use of a displacement (or replacement) factor, and also emphasized that electron contamination should be removed from the photon beam for measuring $PDD(10)_x$. According to these authors the latter can be achieved using a thin lead foil as filter, which has become the method recommended by the AAPM TG-51 [51] dosimetry protocol.

C.2. Advantages and disadvantages of $TPR_{20,10}$

For clinical beams in the most widely used energy region ($TPR_{20,10}$ between 0.50 and 0.70 approximately⁴⁸) the small variation of stopping-power ratios, and therefore in $N_{D,w}$, with $TPR_{20,10}$ has an important advantage in the final uncertainty of the determination of the absorbed dose to water at the reference point, as possible errors in the measurement of $TPR_{20,10}$ do not yield a significant change in the value of the stopping-power ratio [22]. From a compilation of 21 clinical spectra published by different authors and 16 additional calculated spectra corresponding to clinical beams [78], it has been shown that stopping-power ratios and $TPR_{20,10}$ are very well correlated and lie on an almost universal curve. These stopping-power ratios can be fitted to better than 0.15% for practically all the clinical spectra with a cubic polynomial, see Fig. C.1, where the stopping power data and $TPR_{20,10}$ values are taken from reference [144]. Measurements made by Followill *et al* [79] on 685 photon beams from 45 different accelerators with energies ranging from 4 MV to 25 MV have shown very few $TPR_{20,10}$ values above 0.8 approximately, and their estimated water/air stopping-power ratios for the entire data set had a spread of $\pm 0.25\%$. For the few beams with $TPR_{20,10}$ higher than 0.75 or so, the steep gradient of the stopping-power ratio versus $TPR_{20,10}$ curve could result in the propagation of possible errors in measuring $TPR_{20,10}$ into

⁴⁸ In a large survey carried out by the Radiological Physics Center in Houston [169] for which the summary of RPC-measured depth-dose data was updated in 1996 (W. Hanson, private communication), of approximately 1200 clinical accelerators investigated in North America, more than 80% of the machines had a maximum nominal accelerating potential of 10 MV or less. This figure is expected to be even larger in the less industrialized countries.

larger variations in stopping-power ratios, and therefore in k_Q , than for lower beam qualities but these variations will, in most cases, not be larger than 0.5%.

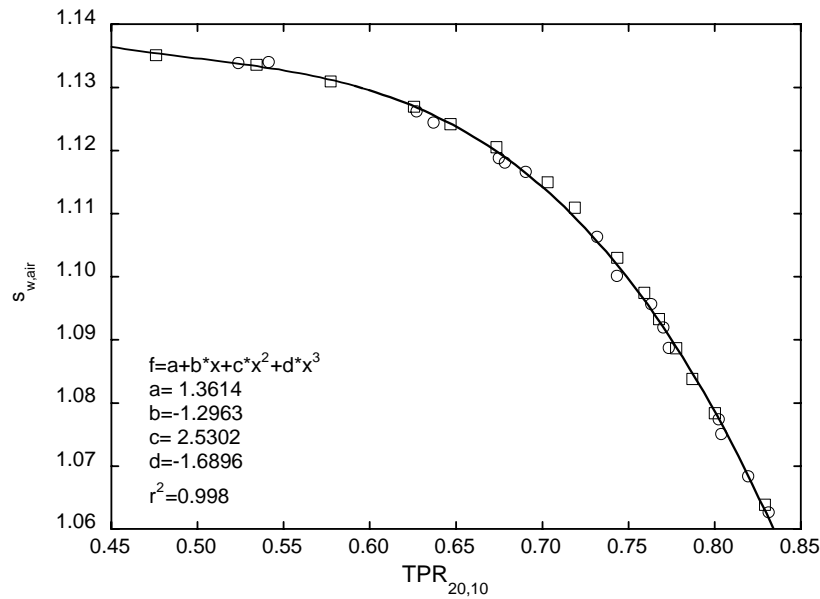

Fig. C.1. Spencer-Attix ($\Delta=10$ keV, $\delta_{ICRU/Ashley}$) water/air stopping-power ratios for clinical photon beams as a function of the quality of the photon beam $TPR_{20,10}$. Circles correspond to spectra published by different authors (c.f. Table 2 in reference [78]) and squares represent the calculated spectra in the same reference. The solid line is a cubic polynomial, fitting the data to better than 0.15%. Stopping power data and $TPR_{20,10}$ values taken from reference [144].

There have been misinterpretations in the literature [147, 165] where data for *idealized* beams (i.e., beams which do not exist in reality such as mono-energetic photons, thin target Schiff-bremsstrahlung spectra, etc) which had been calculated for illustrative and teaching purposes [170], have been used as an argument against the use of $TPR_{20,10}$. Some of these data are reproduced in Fig. C.2, and it is worth clarifying that the intention with such calculations was, in fact, to demonstrate that even for those non-existing hypothetical beams, the largest variation in stopping-power ratios would never exceed 1%. Unfortunately, these data have been misinterpreted and the argument has been reversed and used as an “evidence” against the use of $TPR_{20,10}$ [147, 165]. In any case it should not be forgotten that, as in the case of kilovoltage x-ray dosimetry, in which the use of HVL must be complemented with information on beam filtration and kV, $TPR_{20,10}$ can be meaningless if the accelerator potential and the target and filter combinations used to derive stopping-power data are completely ignored.

The advantage of a small variation of stopping-power ratios with $TPR_{20,10}$ in the majority of clinical environments has been argued [147, 165, 171] to be a limitation in a standards laboratory because different beam qualities might yield similar ion chamber calibration factors. On the contrary, it has to be argued that if chamber response varies slowly at a given beam quality range, this should not be a problem as the chamber response both at the standards laboratory and at the hospital will be similar.

The major argument against $TPR_{20,10}$ has been its limitation to select, with an accuracy better than 0.5% or so, stopping-power ratios for the very high-energy photon beams produced by non-conventional clinical accelerators (for example scanned beams without flattening filter) or accelerators used in one or two standards laboratories having targets and filters considerably thicker than in clinical machines. For example, as described by Ross *et al* [172], the photon beams at the standards laboratory in Canada are produced with a 4.5-6 cm thick aluminium fully stopping target and 10-15 cm thick aluminium filters, which cannot be accommodated in the therapeutic head of a clinical accelerator, and have $TPR_{20,10}$ values in the range 0.75-0.83. However it is this capability of distinguishing a beam “forced to look like a

clinical beam” by using non-clinical targets and filters, to achieve the same $TPR_{20,10}$ as in a clinical beam, that makes this quality index attractive. At high photon energies, for these unconventional and non-clinical accelerators, the steep gradient of the stopping-power ratios versus $TPR_{20,10}$ might in some extreme cases yield stopping-power ratios different from those resulting from a detailed Monte Carlo calculation, but still the selection is well within the range of the estimated uncertainty of stopping-power ratios which is of the order of 0.6% for high-energy photons [22, 53]. At a standards laboratory it is in this region where $TPR_{20,10}$ can easily show differences in calibration factors for similar beam qualities (but not identical), which can not be distinguished with specifiers based on percentage depth-dose distributions like $PDD(10)_x$; at this range of beam qualities $TPR_{20,10}$ is a more sensitive specifier than $PDD(10)_x$.

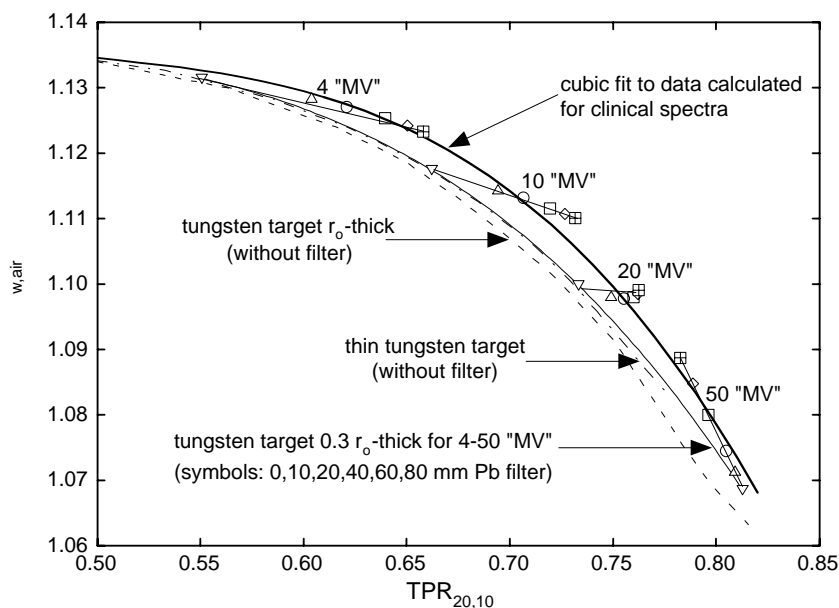

Fig. C.2. Calculated water/air stopping-power ratios for various target and filter combinations as a function of the quality of the photon beam $TPR_{20,10}$. Data for tungsten targets without filter are represented by the dashed-dotted line (thin target), the dashed line (thickness equal to the electron csda range in tungsten) and the thin solid line (thickness equal to one third of the electron csda range in tungsten). The symbols correspond to the $r_0/3$ -thick target spectra for several “MV” (for clarity a line joins the symbols for each energy) after a filtration with different thicknesses of lead (inverted triangles, no filter; normal triangles, 10 mm; circles, 20 mm; squares, 40 mm; trapezoids, 60 mm; crossed squares, 80 mm). The thick solid line is the cubic fit to data calculated for clinical beams shown in Fig. C.1. Adapted from references [53, 84].

On the practical side $TPR_{20,10}$ is very simple to measure in a clinical beam (usually vertical), as once the phantom and the detector are fixed, only the water level has to be changed and the distance from the source to the detector is not relevant (TPR or TAR are independent of distance from the source). Any errors in the position of the detector will mostly cancel out in the measurements at two depths. For the same reason, the uncertainty associated with the displacement effect or the position of the effective point of measurement of the detector plays a minor role.

C.3. Advantages and disadvantages of $PDD(10)_x$

It is important to emphasize that, in principle, stopping-power ratios and k_Q values could easily be related to any parameter indicating the penetration characteristics of photon beams, as both stopping-power ratios and dose distributions are usually determined in a correlated manner using a Monte Carlo calculation. Fig. C.3 illustrates the variation of water/air stopping-power ratios with different photon beam quality specifiers, $TPR_{20,10}$, $PDD(10)$ and d_{80} , using the beam quality parameters given in table 5.iii of BJR Suppl. 25 [81]. The basic stopping-power ratios have been obtained first for the $TPR_{20,10}$ data

using the fit given in Fig C.1 for clinical beam spectra, and have then been converted to the other specifiers using the BJR-25 data.

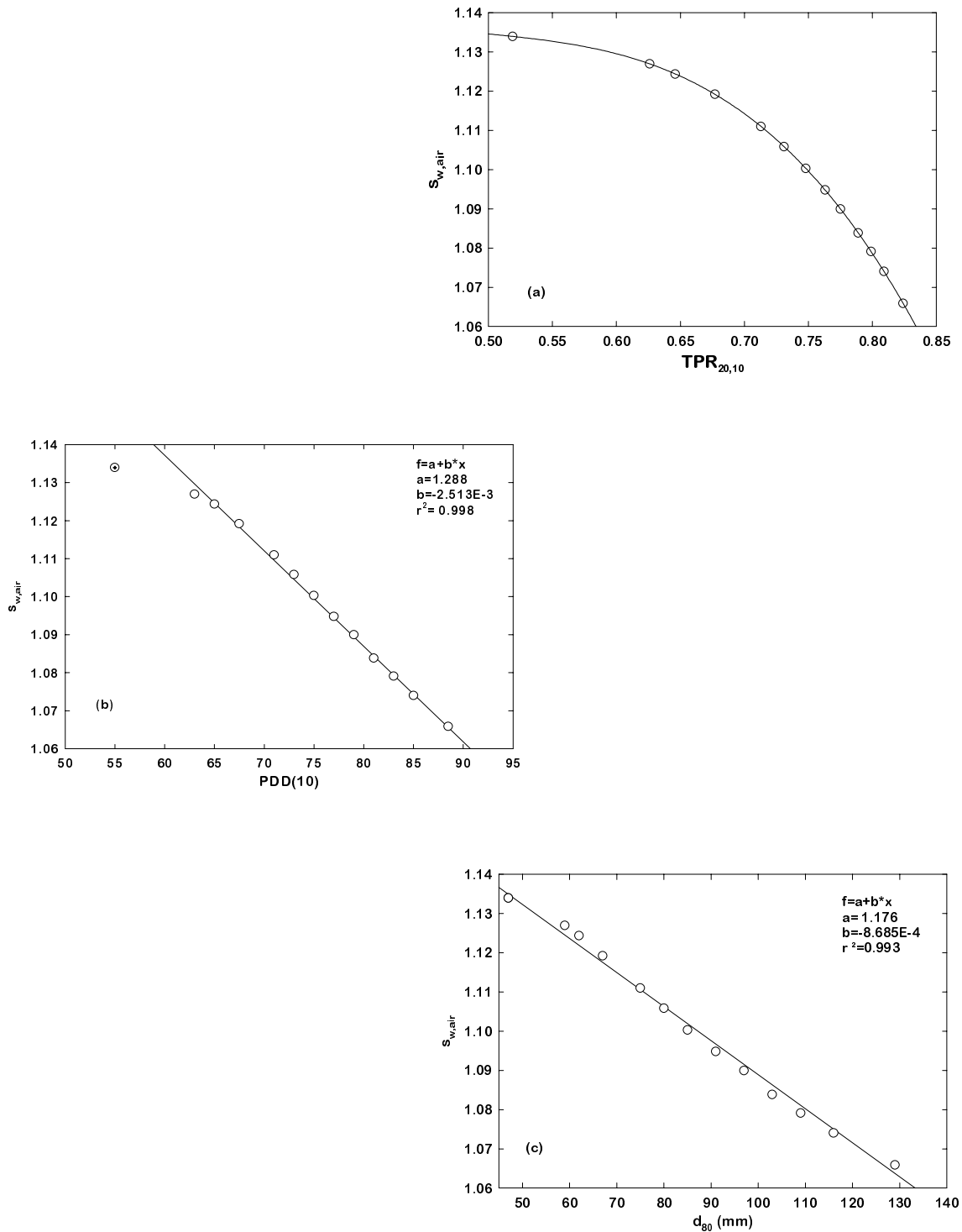

Fig. C.3. Spencer-Attix ($\Delta=10$ keV, $\delta_{ICRU/Ashley}$) water/air stopping-power ratios versus different photon beam quality specifiers: (a) $TPR_{20,10}$; (b) $PDD(10)$; and (c) d_{80} . The basic stopping-power ratios are derived for the $TPR_{20,10}$ data in BJR Suppl. 25 [81] using the cubic fit of Fig C.1; these have been converted to the other specifiers using the data given in BJR-25. In figure (b) for $PDD(10)$ the data point at 2 MV (circle with cross) has not been used in the linear fit. The solid lines represent fits of the stopping-power ratios to each beam quality specifier for the data set from BJR-25.

The fits included in the plots show that it is possible to derive a close relation for any specifier (the data point at 2 MV has not been included in the fit for $PDD(10)$ given here, nor was it included in those given in references [165, 171, 173, 174]), and similar plots could have been produced also for broad or narrow beam attenuation coefficients. Note in particular that the linear correlation with the beam quality specifier recommended in BJR-25, d_{80} , is excellent for the entire range of energies used in this comparison. Considering that the depth-dose data have been averaged over many types of clinical accelerators (from BJR Suppl. 25 [81]) it could be assumed that these simple linear fits are representative of clinical data. However, as the electron contamination varies from machine to machine, this indirect procedure has never been recommended and only the data expressed as a function of $TPR_{20,10}$ can be used independently of contamination.

Calculating the stopping-power ratio data directly as a function of $PDD(10)$ or d_{80} for realistic beams is not possible due to the lack of information on the spectra of contaminant electrons, which would be required as input to the calculations. Instead, the parameter $PDD(10)_x$, i.e. $PDD(10)$ for “pure photon beams”, has been recommended to select stopping-power ratios [147, 165]. The problem is that in reality “pure photon beams” do not exist. Therefore, beam quality specification must rely either on a simple practical parameter which is truly related to the intrinsic physics of photon interactions (like a practical attenuation coefficient, which is equivalent to using $TPR_{20,10}$) or the problems associated with electron contamination will cancel any possible theoretical advantage in a simple linear fit valid for most practical beams. In the latter case the difficulty with relating a “pure photon beam” parameter to a parameter easily measurable in a hospital is a major limitation which will be discussed below. A related problem which has received little attention in the assignment of stopping-power ratios to Monte Carlo calculated depth-dose distributions is the statistical noise that appears in depth-dose data. Fig. C.4 illustrates this situation, which is specially relevant in the region around the depth of maximum dose, z_{max} . The histogram in the figure corresponds to the simulation, using the Monte Carlo code DOSRZ/EGS4 [175], of 15 million histories of 10 MeV monoenergetic photons in a 1 mm depth grid, and shows the difficulty of finding values of the dose at z_{max} and at a single depth (for $PDD(10)$ or d_{80}) due to the statistical noise of the Monte Carlo data. For comparison, the solid line corresponds to a convolution of calculated energy-deposition kernels which overcomes this problem; the procedure has been used to derive the correlation between $TPR_{20,10}$ and stopping-power ratios in reference [144] shown in Fig. C.1.

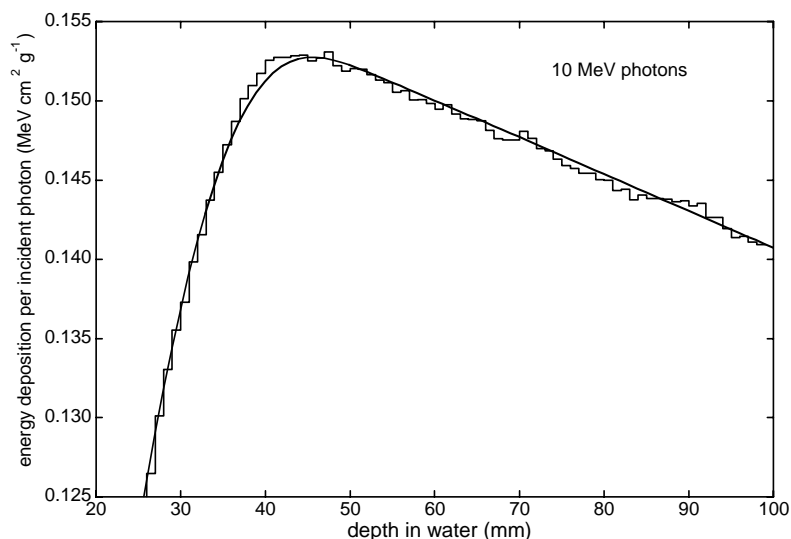

Fig. C.4. Comparison between central-axis depth-dose distributions for 10 MeV monoenergetic photon beams obtained from a Monte Carlo simulations using the code DOSRZ/EGS4 [175] (the histogram corresponds to 15 million photon histories using a 1 mm depth grid) and from the convolution of calculated energy-deposition kernels (solid line). The plot illustrates the difficulty to derive values of the dose at z_{max} and at a single depth due to the statistical noise of the Monte Carlo data, but the problem can be overcome with the use of kernels. Data taken from reference [144].

The linearity of the relation between $PDD(10)_x$ and stopping-power ratios for all types of beams, even for those not available in hospitals, has been a major argument for promoting the use of $PDD(10)_x$ as a photon beam quality specifier and minimizing the importance of electron contamination. There have been efforts by some standards laboratories to have $PDD(10)_x$ accepted so that these laboratories can have their accelerators showing a specification similar to that found in clinical machines, even if the accelerator energy is very different. It is unfortunate that practically all the experimental comparisons showing the “superiority” of $PDD(10)_x$ over $TPR_{20,10}$ have been made on non-clinical accelerators at standards laboratories [172, 176]. In a recent publication [177] where k_Q values were determined in the photon beams of a standards laboratory, a statement concluding “support $PDD(10)$ as a better beam quality specifier” was given even when the electron contamination contribution to the dose at z_{max} had been estimated in a crude way and $PDD(10)$ corrected according to such an estimation. Other major laboratories, on the other hand, do have clinical beams or intend to install a clinical treatment head.

As all the specifiers based on percentage depth-dose distributions are affected by the electron contamination of the beam, identical photon spectra with different contamination would appear as having different qualities, even when their dosimetric properties at depth (attenuation, stopping-power ratios, etc) are the same. These specifiers thus have a closer relation to the manufacturer’s design of an accelerator treatment head, which is the major source of contaminant electrons, than with the physics governing the penetration of photon beams. To remove electron contamination an appropriate “electron filter” should be used. The ideal solution would be a purging magnet (*c.f.* reference [84]), but this is seldom available and only some versions of racetrack microtron accelerators include such a special device. As already mentioned, the use of a lead foil has been suggested by a group of authors [165, 173] and this has been the recommendation of the AAPM TG-51 protocol [51]. It is surprising that a material like lead has been recommended, when it has long been well known that lead in itself is an additional source of contaminant electrons. This was recognized in early radiotherapy in relation with skin sparing problems produced by electrons originated in lead blocks and, for instance, ICRU Reports 10b and 10d [98, 178] recommended using materials of intermediate atomic number, such as copper, iron or brass, as filters to minimize electron production.

Having decided that an electron lead filter will be used, a relation between the *uncontaminated* non-clinical photon beam and the contaminated clinical beam must be established for the accelerator and filter used in specific conditions. The term *uncontaminated* deserves special attention because the lead filter used to measure depth-dose data produces new electron contamination whose consequences have not been studied in detail for a large number of clinical photon spectra. What is available today is a set of empirical equations, derived for a few examples, all requiring several steps and the use of multiple parameters and approximations. Rogers [147], for example, has provided a relationship between $PDD(10)$ and $PDD(10)_x$ which is based only on two sets of measured data. Also, the series of publications by Rogers and colleagues on this topic [165, 171, 173, 174] is based on a so-called “standard set” of photon beam spectra, which contains only five typical clinical beams (those calculated by Mohan *et al* [179]), but no further accelerator photon beams have been modelled and simple electron spectra have been used as inputs to some of the necessary calculations [174]. Whereas the scientific interest of these calculations is unquestionable, on the practical side one could question if the uncertainty introduced by the various steps and general fits does not counter-balance the hypothetical advantage of using a “pure photon beam” parameter.

An elementary question which may be raised in relation to this topic is, *if all electron contamination can be removed from z_{max} and a depth-dose curve can be measured with satisfactory accuracy by every user, then why is the depth of maximum dose z_{max} not recommended for photon beam calibration, instead of at a depth of 10 cm?* This would eliminate the step of transferring the dose from a larger depth to z_{max} , which is used by most medical physicists for performing clinical reference dosimetry. In this case, only a relative measurement between the filtered and the non-filtered beam would be necessary, exactly as for measuring relative field outputs. This question has not been addressed by the various publications which recommend that $PDD(10)_x$ be used as a beam quality specifier [165, 171, 173, 174] nor by the AAPM TG-51 protocol [51].

On the practical side problems may arise in the measurement of $PDD(10)_x$, in addition to those related to the positioning of the lead filter whose distance to the phantom surface may be critical [174]. Because only one depth is relevant, this specifier is affected by errors in the positioning of the chamber at depth, although the influence on the determination of absorbed dose is probably very small. Care should be taken when $PDD(10)_x$ is measured with cylindrical chambers due to the position of the effective point of measurement of the ionization chamber, or to the need for using a displacement (replacement) factor for the measurement at 10 cm depth but not at the depth of the maximum absorbed dose. The depth of the maximum dose may be different in the filtered and non-filtered beams, so that accurate depth-doses down to at least 10 cm depth need to be measured in both conditions, and it is well known that these may vary with the type of detector and measuring device used. Any systematic error in the measuring set up (SSD, depths, etc) will also change the measured $PDD(10)_x$.

These practical problems and their influence on the final dose determination have been omitted in most occasions where $PDD(10)_x$ has been recommended as a beam quality specifier [165, 171, 173, 174] and in the AAPM TG-51 protocol [51]. The user may then decide that it is not worth measuring $PDD(10)_x$ under careful reference conditions. Even the possible impact of electron contamination has been minimized to such an extent in these references, where often a clear distinction between $PDD(10)_x$ and $PDD(10)$ is omitted in the concluding remarks [165, 173], that users may feel it is unnecessary to use an electron filter for measuring $PDD(10)_x$, and use instead $PDD(10)$ in an open beam (or the typical values given in BJR-25 [81]). This may be acceptable for relatively clean beams, yielding errors probably less than 0.5%, but may have detrimental dosimetry consequences for beams with significant electron contamination. The risk for having users oversimplifying dosimetry procedures should not be ignored or otherwise the possible advantages of implementing new dosimetry protocols may be jeopardized.

C.4. Concluding remarks

The general conclusion is that there is no unique beam quality specifier that works satisfactorily in all possible conditions for the entire energy range of photon energies used in radiotherapy and all possible accelerators used in hospitals and in standards laboratories.

The most recent dosimetry protocols or Codes of Practice, based on the calibration of ionization chambers in terms of absorbed dose to water, use a photon beam quality specifier in terms of $TPR_{20,10}$ (IPSM, UK [49]; DIN, Germany [50]) and this is also the choice in the present International Code of Practice. The AAPM TG-51 protocol in North America [51] uses $PDD(10)_x$.

For a hospital user there is strictly no advantage of one index over the other, as both sets of data, PDD and TPR (or TMR), are available for routine clinical use. However, there are more practical problems with measuring $PDD(10)_x$ than with $TPR_{20,10}$, and errors in determining the beam quality index may have in general more adverse consequences with $PDD(10)_x$ than with $TPR_{20,10}$. The final impact on clinical photon beam dosimetry resulting from the use of different photon beam quality specifiers to select k_Q values, is that they are not expected to yield a significant change (i.e., more than 0.5% and in most cases they agree within 0.2% [180]) in the value of the absorbed dose to water in reference conditions for most clinical beams. This difference is considerably smaller than the combined uncertainty of the different factors and coefficients used in photon dosimetry. In addition, for standard laboratories the use of $PDD(10)_x$ would require having different set ups for measuring beam quality and for the calibration of ionization chambers, what may result in increased calibration costs for the user. A change that does not improve photon dosimetry at the hospital and has so many complications from a practical point of view for the user does not appear to be justified.

APPENDIX D. EXPRESSION OF UNCERTAINTIES

The evaluation of uncertainties in this Code of Practice follows the guidance given by ISO [32]. In 1986 the ISO was given the task of developing detailed guidelines for the evaluation of uncertainties based on the new unified approach outlined in the BIPM Recommendation INC-1. These recommendations were approved by the *Comité International des Poids et Mesures* [181]. This effort resulted in the issue in 1993 of the ISO document entitled *Guide to the Expression of Uncertainty in Measurement*, with a first corrected edition published in 1995 [32]. The guide should be consulted for further details. This Appendix provides a practical implementation of the ISO recommendations, based on the summaries provided in IAEA TRS-374 [33] and IAEA TRS-277 [17].

D.1 General considerations on errors and uncertainties

Contrary to earlier practice, when the terms *error* and *uncertainty* were used interchangeably, the modern approach, initiated by the *Comité International des Poids et Mesures* [181], distinguishes between these two concepts. Traditionally an error has been viewed as having two components, namely a *random* component and a *systematic* component. According to present definitions, an *error* is the difference between a measured value and the *true* value. If errors were known exactly, the true value could be determined; in reality, errors are estimated in the best possible way and corrections are made for them. Therefore, after application of all known corrections, errors do not need any further consideration (their expectation value being zero) and the quantities of interest are uncertainties. An error has both a numerical value and a sign. In contrast, the *uncertainty* associated with a measurement is a parameter that characterizes the dispersion of the values “that could reasonably be attributed to the measurand”. This parameter is normally an estimated standard deviation. An uncertainty, therefore, has no known sign and is usually assumed to be symmetrical. It is a measure of our lack of exact knowledge, after all recognized *systematic* effects have been eliminated by applying appropriate corrections.

Uncertainties of measurements are expressed as relative standard uncertainties and the evaluation of standard uncertainties is classified into type A and type B. The method of evaluation of type A standard uncertainties is by statistical analysis of a series of observations, whereas the method of evaluation of type B standard uncertainties is based on means other than statistical analysis of a series of observations.

In the traditional categorization of uncertainties it was usual to distinguish between *random* and *systematic* contributions. This is undesirable because classifying the components instead of the method of evaluation is prone to ambiguities. For example a random component of uncertainty in one measurement may become a systematic component of uncertainty in another measurement in which the result of the first measurement is used as an input datum.

D.2 Type A standard uncertainties

In a series of n measurements, with observed values x_i , the best estimate of the quantity x is usually given by the *arithmetic mean* value

$$\bar{x} = \frac{1}{n} \sum_{i=1}^n x_i \quad (\text{D.1})$$

The scatter of the n measured values x_i , around their mean \bar{x} can be characterized by the *standard deviation*

$$s(x_i) = \sqrt{\frac{1}{n-1} \sum_{i=1}^n (x_i - \bar{x})^2} \quad (\text{D.2})$$

and the quantity $s^2(x_i)$ is called the sample variance.

We are often interested in the standard deviation of the mean value, written as $s(\bar{x})$, for which the general relation

$$s(\bar{x}) = \frac{1}{\sqrt{n}} s(x_i) \quad (\text{D.3})$$

applies. An alternative way to estimate $s(\bar{x})$ would be based on the outcome of several groups of measurements. If they are all of the same size, the formulas given above can still be used, provided that x_i is now taken as the mean of group i and \bar{x} is the overall mean (or mean of the means) of the n groups. For groups of different size, *statistical weights* would have to be used. This second approach may often be preferable, but it usually requires a larger number of measurements. A discussion of how much the two results of $s(\bar{x})$ may differ from each other is beyond this elementary presentation.

The *standard uncertainty of Type A*, denoted here by u_A , will be identified with the standard deviation of the mean value, i.e.

$$u_A = s(\bar{x}) \quad (\text{D.4})$$

Obviously, an empirical determination of an uncertainty cannot be expected to give its *true* value; it is by definition only an estimate. This is so for both Type A and Type B uncertainties. It will be noted from Eq. (D.3) that a Type A uncertainty on the measurement of a quantity can, in principle, always be reduced by increasing the number n of individual readings. If several measurement techniques are available, the preference will go to the one which gives the least scatter of the results, i.e. which has the smallest standard deviation $s(x_i)$, but in practice the possibilities for reduction are often limited.

In the past, uncertainties owing to random effects have often been evaluated in the form of confidence limits, commonly at the 95% confidence level. This approach is not used now because there is no statistical basis for combining confidence limits. The theory of the propagation of uncertainties requires combination in terms of variances.

D.3 Type B standard uncertainties

There are many sources of measurement uncertainty that cannot be estimated by repeated measurements. They are called Type B uncertainties. These include not only unknown, although suspected, influences on the measurement process, but also little known effects of influence quantities (pressure, temperature, etc.), application of correction factors or physical data taken from the literature, etc.

Type B uncertainties must be estimated so that they correspond to standard deviations; they are called *Type B standard uncertainties*. Some experimenters claim that they can estimate directly this type of uncertainty, while others prefer to use, as an intermediate step, some type of limit. It is often helpful to assume that these uncertainties have a probability distribution which corresponds to some easily recognizable shape.

It is sometimes assumed, mainly for the sake of simplicity, that Type B uncertainties can be described by a rectangular probability density, i.e. that they have equal probability anywhere within the given maximum limits - M and + M . It can be shown that with this assumption, the Type B standard uncertainty u_B is given by

$$u_B = \frac{M}{\sqrt{3}} \quad (\text{D.5})$$

Alternatively, if the assumed distribution is triangular (with the same limits), we are led to the relation

$$u_B = \frac{M}{\sqrt{6}} \quad (\text{D.6})$$

Another assumption is that Type B uncertainties have a distribution that is approximately Gaussian (normal). On this assumption, the Type B standard uncertainty can be derived by first estimating some limits $\pm L$ and then dividing that limit by a suitable number. If, for example, the experimenter is *fairly sure* of the limit L , it can be considered to correspond approximately to a 95% confidence limit, whereas if the experimenter is *almost certain*, it may be taken to correspond approximately to a 99% confidence limit. Thus, the Type B standard uncertainty u_B can be obtained from the equation

$$u_B = \frac{L}{k} \quad (\text{D.7})$$

where $k=2$ if the experimenter is fairly sure and $k=3$ if the experimenter is almost certain of his or her estimated limits $\pm L$. These relations correspond to the properties of a Gaussian distribution and it is usually not worthwhile to apply divisors other than 2 or 3 because of the approximate nature of the estimation.

There are thus no rigid rules for estimating Type B standard uncertainties. The experimenter should use his or her best knowledge and experience and, whichever method is applied, provide estimates that can be used as if they were standard deviations. There is hardly ever any meaning in estimating Type B uncertainties to more than one significant figure, and certainly never to more than two.

D.4 Combined and expanded uncertainties

Because Type A and Type B uncertainties are both estimated standard deviations, they are combined using the statistical rules for combining variances (which are squares of standard deviations). If u_A and u_B are the Type A and Type B standard uncertainties of a quantity, respectively, the combined standard uncertainty of that quantity is

$$u_c = \sqrt{u_A^2 + u_B^2} \quad (\text{D.8})$$

The combined standard uncertainty thus still has the character of a standard deviation. If, in addition, it is believed to have a Gaussian probability density, then the standard deviation corresponds to a confidence limit of about 68%. Therefore, it is often felt desirable to multiply the combined standard uncertainty by a suitable factor, called the *coverage factor*, k , to yield an *expanded uncertainty*. Values of the coverage factor of $k = 2$ or 3, correspond to confidence limits of about 95 or 99%. The approximate nature of uncertainty estimates, in particular for Type B, makes it doubtful that more than one significant figure is ever justified in choosing the coverage factor. In any case, the numerical value taken for the coverage factor should be clearly indicated.

REFERENCES

- [1] ICRU INTERNATIONAL COMMISSION ON RADIATION UNITS AND MEASUREMENTS, Determination of absorbed dose in a patient irradiated by beams of X or gamma rays in radiotherapy procedures, ICRU Report 24, ICRU, Bethesda (1976).
- [2] BRAHME, A., CHAUDAUDRA, J., LANDBERG, T., MCCULLOUGH, E.C., NÜSSLIN, F., RAWLINSON, J.A., SVENSSON, G., SVENSSON, H., Accuracy Requirements and Quality Assurance of External Beam Therapy with Photons and Electrons, *Acta Oncol Suppl* 1 (1988) .
- [3] MIJNHEER, B.J., BATTERMANN, J.J., WAMBERSIE, A., What degree of accuracy is required and can be achieved in photon and neutron therapy?, *Radioth. Oncol.* 8 (1987) 237-252.
- [4] MIJNHEER, B.J., BATTERMANN, J.J., WAMBERSIE, A., Reply to Precision and accuracy in radiotherapy, *Radioth. Oncol.* 14 (1989) 163-167.
- [5] WAMBERSIE, A., VAN DAM, J., HANKS, G., MIJNHEER, B.J., BATTERMANN, J.J., "What accuracy is needed in dosimetry", Seminar on Radiation dose in radiotherapy from prescription to delivery (Proc Symp. Leuven), IAEA, Vienna (1991) 11-35.
- [6] ISO INTERNATIONAL ORGANIZATION FOR STANDARDIZATION, "Quantities and units-Part 0: General principles", ISO International Standard 31-0, ISO, Geneva (1992).
- [7] IEC INTERNATIONAL ELECTROTECHNICAL COMMISSION, Medical Electrical Equipment. Dosimeters with ionization chambers as used in radiotherapy, Standard IEC-60731, IEC, Geneva (1997).
- [8] NACP NORDIC ASSOCIATION OF CLINICAL PHYSICS, Procedures in external radiation therapy dosimetry with electron and photon beams with maximum energies between 1 and 50 MeV, *Acta Radiol Oncol* 19 (1980) 55-79.
- [9] AAPM AMERICAN ASSOCIATION OF PHYSICISTS IN MEDICINE, Task Group 21: A protocol for the determination of absorbed dose from high-energy photon and electron beams, *Med. Phys.* 10 (1983) 741-771.
- [10] HPA HOSPITAL PHYSICISTS' ASSOCIATION, Revised Code of Practice for the dosimetry of 2 to 25 MV x-ray, and of caesium-137 and cobalt-60 gamma-ray beams, *Phys Med Biol* 28 (1983) 1097-1104.
- [11] ICRU INTERNATIONAL COMMISSION ON RADIATION UNITS AND MEASUREMENTS, Radiation Dosimetry: Electron beams with energies between 1 and 50 MeV, ICRU Report 35, ICRU, Bethesda, MD (1984).
- [12] SEFM SOCIEDAD ESPAÑOLA DE FÍSICA MÉDICA, Procedimientos recomendados para la dosimetría de fotones y electrones de energías comprendidas entre 1 MeV y 50 MeV en radioterapia de haces externos, Report SEFM 84-1, SEFM, Madrid (1984).
- [13] SEFM SOCIEDAD ESPAÑOLA DE FÍSICA MÉDICA, Suplemento al Documento 84-1: Procedimientos recomendados para la dosimetría de fotones y electrones de energías comprendidas entre 1 MeV y 50 MeV en radioterapia de haces externos, Report SEFM 87-1, SEFM, Madrid (1987).
- [14] NCS NEDERLANDSE COMMISSIE VOOR STRALINGSDOSIMETRIE, Code of practice for the dosimetry of high-energy photons beams, Report NCS-2, Delft: NCS (1986).
- [15] NCS NEDERLANDSE COMMISSIE VOOR STRALINGSDOSIMETRIE, Code of practice for the dosimetry of high-energy electron beams, Report NCS-5, Delft: NCS (1989).
- [16] SSRBRP SWISS SOCIETY OF RADIATION BIOLOGY AND RADIATION PHYSICS, Dosimetry of high energy photon and electron beams: Recommendations, Garavaglia G ed.; Ospedale San Giovanni, 6500 Bellinzona, Switzerland (1986).
- [17] IAEA INTERNATIONAL ATOMIC ENERGY AGENCY, "Absorbed Dose Determination in Photon and Electron Beams: An International Code of Practice", Technical Report Series no. 277 (2nd ed in 1997), IAEA, Vienna (1987).

- [18] CFMRI COMITÉ FRANÇAIS MESURE DES RAYONNEMENTS IONISANTS, Recommandations pour la mesure de la dose absorbée en radiothérapie dans les faisceaux de photons et d'électrons d'énergie comprise entre 1 MeV et 50 MeV, Rapport CFMRI n° 2, Chiron (1987).
- [19] AIFB ASSOCIAZIONE ITALIANA DI FISICA BIOMEDICA, Protocollo per la dosimetria di base nella radioterapia con fasci di fotoni ed elettroni con E_{\max} fra 1 e 40 MeV, *Fisica Biomedica* Vol. VI (2) (1988) .
- [20] ANDREO, P., Absorbed dose beam quality factors for the dosimetry of high-energy photon beams, *Phys Med Biol* 37 (1992) 2189-2211.
- [21] IAEA INTERNATIONAL ATOMIC ENERGY AGENCY, "The use of plane-parallel ionization chambers in high-energy electron and photon beams. An International Code of Practice for Dosimetry", Technical Report Series no. 381, IAEA, Vienna (1997).
- [22] ANDREO, P., Uncertainties in dosimetric data and beam calibration, *Int. J. Radiation Oncology Biol. Phys.* 19 (1990) 1233-1247.
- [23] THWAITES, D.I., "Uncertainties at the end point of the basic dosimetry chain", Symp. Measurement Assurance in Dosimetry (Proc Symp. Vienna), IAEA, Vienna (1993) 239-255.
- [24] REICH, H., Choice of the measuring quantity for therapy-level doseimeters, *Phys. Med. Biol.* 24 (1979) 895-900.
- [25] CCEMRI(I) COMITÉ CONSULTATIF DES LES ETALONS DE MESURE DES RAYONNEMENTS IONISANTS (SECTION I), Report to the Comite International des Poids et Mesures (N J Hargrave, Rapporteur), 9th Meeting CCEMRI(I), Bureau International des Poids et Mesures, Sevres (1988).
- [26] ICRU INTERNATIONAL COMMISSION ON RADIATION UNITS AND MEASUREMENTS, Clinical neutron dosimetry, Part I: determination of absorbed dose in a patient treated by external beams of fast neutrons, ICRU Report 45, Bethesda, MD: ICRU (1989).
- [27] HOHLFELD, K., "The standard DIN 6800: Procedures for absorbed dose determination in radiology by the ionization method", Dosimetry in Radiotherapy (Proc Symp. Vienna, 1987), Vol. 1, IAEA, Vienna (1988) 13-22.
- [28] ROGERS, D.W.O., The advantages of absorbed-dose calibration factors, *Med. Phys.* 19 (1992) 1227-1239.
- [29] ICRU INTERNATIONAL COMMISSION ON RADIATION UNITS AND MEASUREMENTS, Dosimetry of High-Energy Photon Beams based on Standards of Absorbed Dose to Water, ICRU Report 64, Bethesda, MD: ICRU (2000).
- [30] BOUTILLON, M., PERROCHE, A.M., Determination of calibration factors in terms of air kerma and absorbed dose to water in the Co-60 gamma rays, *IAEA SSDL Newsletter* 32 (1993) 3-13.
- [31] BIELAJEW, A.F., ROGERS, D.W.O., Implications of new correction factors on primary air kerma standards in Co-60 beams, *Phys. Med. Biol.* 37 (1992) 1283-1291.
- [32] ISO INTERNATIONAL ORGANIZATION FOR STANDARDIZATION, "Guide to the expression of uncertainty in measurement, 2nd ed. [Published by ISO in the name of BIPM, IEC, IFCC, IUPAC, IUPAP and OIML]", ISO, Geneva (1995).
- [33] IAEA INTERNATIONAL ATOMIC ENERGY AGENCY, "Calibration of Dosimeters used in Radiotherapy", Technical Report Series no. 374, IAEA, Vienna (1994).
- [34] BIPM BUREAU INTERNATIONAL DES POIDS ET MESURES, "The International System of Units (SI)", BIPM, F-92312 Sevres Cedex (1998).
- [35] OIML ORGANISATION INTERNATIONALE DE METROLOGIE LEGALE, Secondary standard dosimetry laboratories for the calibration of dosimeters used in radiotherapy, Document OIML D-21, OIML, Paris, France (1990).
- [36] IAEA INTERNATIONAL ATOMIC ENERGY AGENCY, "A Charter for the SSDLs", IAEA, Vienna (1999).

- [37] BOUTILLON, M., PERROCHE, A.M., Ionometric determination of absorbed dose to water for cobalt-60 gamma rays, *Phys Med Biol* 38 (1993) 439-454.
- [38] DOMEN, S.R., LAMPERTI, P.J., Heat-loss-compensated calorimeter: Theory, design and performance, *J. Res. Nat. Bur. Stand. A Phys. Chem.* **78A** (1974) 595-610.
- [39] PRUITT, J.S., DOMEN, S.R., LOEVINGER, R., The graphite calorimeter as a standard of absorbed dose for Co-60 gamma radiation, *J Res NBS* (1981) 495-502.
- [40] GUERRA, A.S., LAITANO, R.F., PIMPINELLA, Characteristics of the absorbed dose to water standard at ENEA, *Phys Med Biol* 41 (1996) 657-674.
- [41] DOMEN, S.R., A sealed water calorimeter for measuring absorbed dose, *J. Res. Nat. Inst. Stand. Tech.* 99 (1994) 121-141.
- [42] KLASSEN, N.V., ROSS, C.K., Water calorimetry: the heat defect, *J Res NIST* 102 (1997) 63-74.
- [43] SHORTT, K.R., KLASSEN, N.V., ROSS, C.K., SMITH, G.D., "Ferrous sulphate dosimetry and its role in establishing an absorbed dose to water standard for the National Research Council of Canada", in: Workshop on Water Calorimetry (Report NRC-29637) (Ross, C.K., Klassen, N.V.,ed.), NRC, Ottawa, Canada (1988) 121-126.
- [44] FEIST, H., Determination of the absorbed dose to water for high-energy photons and electrons by total absorption of electrons in ferrous sulfate-solution, *Phy Med Biol* 27 (1982) 1435.
- [45] BÖHM, J., HOHLFELD, K., REICH, H., "A primary standard for determination of absorbed dose in water for X-rays generated at potentials of 7.5 to 30 kV", National and International Standardization of Radiation Dosimetry (Proc Symp. Atlanta, 1977), Vol. 1, IAEA, Vienna (1978) 53-63.
- [46] BOUTILLON, M., COURSEY, B.M., HOHLFELD, K., OWEN, B., ROGERS, D.W.O., "Comparison of primary water absorbed dose standards", Measurement Assurance in Dosimetry (Proc Symp. Vienna, 1993), IAEA, Vienna (1994) 95-111.
- [47] BOUTILLON, M., ANDREO, P., Some thoughts on the dissemination of ND,w calibration factors in Co-60 gamma radiation, Report CCEMRI(I)/97-1, BIPM, Pavillon de Breteuil, F-92312 Sevres (1997).
- [48] ALLISY-ROBERTS, P.J., BURNS, D.T., Comparisons and calibrations at the BIPM, Report CCRI(I)/99-1, BIPM, Pavillon de Breteuil, F-92312 Sevres (1999).
- [49] IPSM INSTITUTE OF PHYSICAL SCIENCES IN MEDICINE, Code of Practice for high-energy photon therapy dosimetry based on the NPL absorbed dose calibration service, *Phys. Med. Biol.* 35 (1990) 1355-1360.
- [50] DIN DEUTSCHES INSTITUT FÜR NORMUNG, Dosismessverfahren nach der Sondenmethode für Photonen- und Elektronenstrahlung, Teil 2: Ionisationsdosimetrie, Deutsche Norm DIN 6800-2, Deutsches Institut für Normung, Berlin (1997).
- [51] AAPM AMERICAN ASSOCIATION OF PHYSICISTS IN MEDICINE, Task Group 51: Protocol for Clinical Reference Dosimetry of High-Energy Photon and Electron Beams, *Med. Phys.* 26 (1999) 1847-1870.
- [52] ISO INTERNATIONAL ORGANIZATION FOR STANDARDIZATION, "International vocabulary of basic and general terms in metrology [Published by ISO in the name of BIPM, IEC, IFCC, IUPAC, IUPAP and OIML]", ISO, Geneva (1993).
- [53] ANDREO, P., The status of high-energy photon and electron beam dosimetry five years after the publication of the IAEA Code of Practice in the Nordic countries, *Acta Oncol.* 32 (1993) 483-500.
- [54] MEDIN, J., ANDREO, P., GRUSELL, E., MATTSSON, O., MONTELIUS, A., ROOS, M., Ionisation chamber dosimetry of proton beams using cylindrical and plane-parallel chambers. Nw versus Nk ion chamber calibrations, *Phys Med Biol* 40 (1995) 1161-1176.

- [55] SVENSSON, H., BRAHME, A., "Recent advances in electron and photon dosimetry", in: Radiation Dosimetry, Physical and Biological Aspects (Orton, C.G.,ed.), Plenum Press, New York (1986) 87-170.
- [56] ROOS, M., HOHLFELD, K., "Status of the primary standard of water absorbed dose for high energy photon and electron radiation at the PTB", Measurement Assurance in Dosimetry (Proc Symp. Vienna, 1993), IAEA, Vienna (1994) 25-33.
- [57] BURNS, J.E., Absorbed-dose calibrations in high-energy photon beams at the National Physical Laboratory: conversion procedure, *Phys. Med. Biol.* 39 (1994) 1555-1575.
- [58] ROSSER, K.E., OWEN, B., DUSAUTOY, A.R., PRITCHARD, D.H., STOKER, I., BREND, C.J., "The NPL absorbed dose to water calibration service for high energy photons", Measurement Assurance in Dosimetry (Proc Symp. Vienna, 1993), IAEA, Vienna (1994) 73-81.
- [59] ROGERS, D.W.O., ROSS, C.K., SHORTT, K.R., KLASSEN, N.V., BIELAJEW, A.F., "Towards a dosimetry system based on absorbed dose standards", Measurement Assurance in Dosimetry (Proc Symp. Vienna, 1993), IAEA, Vienna (1994)
- [60] SHARPE, P., Progress report on radiation dosimetry at NPL, Report CCRI(I)/99-20, BIPM, Pavillon de Breteuil, F-92312 Sevres, Sevres, France (1999).
- [61] MIJNHEER, B.J., Variations in response to radiation of a nylon-walled ionization chamber induced by humidity changes, *Med. Phys.* 12 (1985) 625-626.
- [62] ICRU INTERNATIONAL COMMISSION ON RADIATION UNITS AND MEASUREMENTS, Tissue Substitutes in Radiation Dosimetry and Measurement, ICRU Report 44, ICRU, Bethesda, MD (1989).
- [63] AGOSTINELLI, A.G., SMOLEN, S.D., NATH, R., A new water-equivalent plastic for dosimetry calibration, *Med Phys* 19 (1992) 774.
- [64] TELLO, V.M., TAILOR, R.C., HANSON, W.F., How water equivalent are water-equivalent plastics for output calibration of photon and electron beams?, *Med. Phys.* 22 (1995) 1177-1189.
- [65] THWAITES, D.I., Charge storage effect on dose in insulating phantoms irradiated with electrons, *Phys Med Biol* 29 (1984) 1153.
- [66] ICRU INTERNATIONAL COMMISSION ON RADIATION UNITS AND MEASUREMENTS, Stopping Powers for Electrons and Positrons, ICRU Report 37, Bethesda, MD: ICRU (1984).
- [67] HANSON, W.F., ARNOLD, D.J., SHALEK, R.J., HUMPHRIES, L.J., Contamination of ionization chambers by talcum powder, *Med Phys* 15 (1988) 776-777.
- [68] CCEMRI(I) COMITÉ CONSULTATIF DES LES ETALONS DE MESURE DES RAYONNEMENTS IONISANTS (SECTION I), Correction d'humidité, CCEMRI(I) R(I)-30, Bureau International des Poids et Mesures, Sevres (1977).
- [69] NISBET, A., THWAITES, D.I., Polarity and ion recombination correction factors for ionization chambers employed in electron beam dosimetry, *Phys. Med. Biol.* 43 (1998) 435-443.
- [70] BOAG, J.W., Ionization measurements at very high intensities. I. Pulsed radiation beams, *Brit J Radiol* 23 (1950) 601.
- [71] IAEA INTERNATIONAL ATOMIC ENERGY AGENCY, "Manual of Dosimetry in Radiotherapy", Technical Report Series no. 110, IAEA, Vienna (1970).
- [72] BOAG, J.W., CURRANT, J., Current collection and ionic recombination in small cylindrical ionization chambers exposed to pulsed radiation, *Brit J Radiol* 53 (1980) 471.
- [73] BURNS, D.T., MCEWEN, M.R., Ion recombination corrections for the NACP parallel-plate chamber in a pulsed electron beam, *Phys Med Biol* 43 (1998) 2033-2045.
- [74] DERIKUM, K., ROOS, M., Measurement of saturation correction factors of thimble-type ionization chambers in pulsed photon beams, *Phys. Med. Biol.* 38 (1993) 755-763.
- [75] BURNS, J.E., BURNS, D.T., Comments on "Ion recombination corrections for plane-parallel and thimble chambers in electron and photon radiation", *Phys. Med. Biol.* 38 (1993) 1986-1988.
- [76] WEINHOUS, M.S., MELI, J.A., Determining Pion, the correction factor for recombination losses in an ionization chamber, *Med. Phys.* 11 (1984) 846-849.

- [77] ESTRO EUROPEAN SOCIETY FOR THERAPEUTIC RADIOLOGY AND ONCOLOGY, IAEA INTERNATIONAL ATOMIC ENERGY AGENCY, "Monitor unit calculation for high energy photon beams", ESTRO Booklet no. 3 (Physics for Clinical Radiotherapy), Garant, Leuven (1997).
- [78] ANDREO, P., BRAHME, A., Stopping power data for high energy photon beams, *Phys Med Biol* 31 (1986) 839-858.
- [79] FOLLOWILL, D.S., TAILOR, R.C., TELLO, V.M., HANSON, W.F., An empirical relationship for determining photon beam quality in TG-21 from a ratio of percent depth doses, *Med Phys* 25 (1998) 1202-1205.
- [80] ANDREO, P., NAHUM, A.E., BRAHME, A., Chamber-dependent wall correction factors in dosimetry, *Phys Med Biol* 31 (1986) 1189-1199.
- [81] BRITISH INSTITUTE OF RADIOLOGY, Central axis depth dose data for use in Radiotherapy, Brit. J. Radiol. Supplement no. 25, The British Institute of Radiology, London (1996).
- [82] BRAHME, A., SVENSSON, H., Radiation beam characteristics of a 22 MeV microtron, *Acta Radiol Oncol* 18 (1979) 244-272.
- [83] GREENING, J.R., "Fundamentals of Radiation Dosimetry", Med. Phys. Handbooks, Adam Hilger Ltd, Bristol (1981).
- [84] BRAHME, A., ANDREO, P., Dosimetry and quality specification of high energy photon beams, *Acta Radiol Oncol* 25 (1986) 213-223.
- [85] ANDREO, P., On the beam quality specification of high-energy photons for radiotherapy dosimetry, *Med. Phys.* 27 (2000) 434-440.
- [86] BURNS, J.E., DALE, J.W.G., Conversion of absorbed dose calibration from graphite into water, NPL Report RSA(EXT) 7, National Physical Laboratory, Teddington, UK (1990).
- [87] BRITISH INSTITUTE OF RADIOLOGY, Central axis depth dose data for use in Radiotherapy, Brit. J. Radiol. Supplement no. 17, The British Institute of Radiology, London (1983).
- [88] BOAS, J.F., HUNTLEY, R.B., WEBB, D.V., WISE, K.N., DUANE, S., ROSSER, K., STOKER, I., THOMAS, R., A comparison of absorbed dose standards for Co-60 and megavoltage photon radiations, *Phys Med Biol* submitted (2000) .
- [89] SHORTT, K.R., ROSS, C.K., SCHNEIDER, M., HOHLFELD, K., ROOS, M., PERROCHE, A.M., A comparison of absorbed dose standards for high-energy x-rays, *Phys. Med. Biol.* 38 (1993) 1937-1955.
- [90] JOHNS, H.E., CUNNINGHAM, J.R., "The Physics of Radiology", Thomas, Springfield, Ill (1983).
- [91] BURNS, D.T., DING, G.X., ROGERS, D.W.O., R_{50} as a beam quality specifier for selecting stopping-power ratios and reference depths for electron dosimetry, *Med Phys* 23 (1996) 383-388.
- [92] DING, G.X., ROGERS, D.W.O., MACKIE, T.R., Calculation of stopping-power ratios using realistic clinical electron beams, *Med. Phys.* 22 (1995) 489-501.
- [93] FERNANDEZ-VAREA, J.M., ANDREO, P., TABATA, T., Detour factors in water and plastic phantoms and their use for range and depth-dose scaling in electron beam dosimetry, *Phys. Med. Biol.* 41 (1996) 1119-1139.
- [94] TABATA, T., ANDREO, P., Semiempirical formulas for the detour factor of 1 to 50 MeV electrons in condensed materials, *Rad. Phys. Chem.* 53 (1998) 353-360.
- [95] NISBET, A., THWAITES, D.I., An evaluation of epoxy resin phantom materials for electron dosimetry, *Phys Med Biol* 43 (1998) 1523-1528.
- [96] IPEMB INSTITUTE OF PHYSICS AND ENGINEERING IN MEDICINE AND BIOLOGY, The IPEMB code of practice for the determination of absorbed dose for x-rays below 300 kV generating potential (0.035 mm Al - 4 mm Cu; 10 - 300 kV generating potential), *Phys. Med. Biol.* 41 (1996) 2605-2625.

- [97] NCS NEDERLANDSE COMMISSIE VOOR STRALINGSDOSIMETRIE, Dosimetry of low and medium energy x-rays, a code of practice for use in radiotherapy and radiobiology, Report NCS-10, Delft: NCS (1997).
- [98] ICRU INTERNATIONAL COMMISSION ON RADIATION UNITS AND MEASUREMENTS, Physical aspects of irradiation, ICRU Report 10b, ICRU, Bethesda, MD (1962).
- [99] SEUNTJENS, J., THIERENS, H., VAN DER PLAETSEN, A., SEGAERT, O., Conversion factor f for x-ray beam qualities, specified by peak tube potential and HVL value, *Phys Med Biol* 32 (1987) 595-603.
- [100] KLEVENHAGEN, S.C., THWAITES, D.I., "Kilovoltage x-rays", in: Radiotherapy Physics in practice (Williams, J.R., Thwaites, D.I., ed.), Oxford University Press, Oxford (1993) 95-112.
- [101] HAVERCROFT, J.M., KLEVENHAGEN, S.C., Ion recombination corrections for plane-parallel and thimble chambers in electron and photon radiation, *Phys. Med. Biol.* 38 (1993) 25-38.
- [102] ROSSER, K.E., An alternative beam quality index for medium-energy x-ray dosimetry, *Phys Med Biol* 43 (1998) 587-598.
- [103] MA, C.M., NAHUM, A.E., Bragg-Gray theory and ion chamber dosimetry for photon beams, *Phys. Med. Biol.* 36 (1991) 413-428.
- [104] SEUNTJENS, J.P., VERHAEGEN, F., Dependence of overall correction factor of a cylindrical ionization chamber on field size and depth in medium-energy x-ray beams, *Med. Phys.* 23 (1996) 1789-1796.
- [105] LI, X.A., MA, C.-M., SALHANI, D., Measurement of percentage depth dose and lateral beam profile for kilovoltage x-ray therapy beams, *Phys. Med. Biol.* 42 (1997) 2561-2568.
- [106] MA, C.-M., LI, X.A., SEUNTJENS, J., Consistency study on kilovoltage x-ray beam dosimetry for radiotherapy, *Med Phys* 25 (1998) 2376-2384.
- [107] PEDRONI, E., BACHER, R., BLATTMAN, H., BÖHRINGER, T., CORAY, A., LOMAX, A., SHIXIONG, L., MUNKEL, G., SCHEIB, S., SCHNEIDER, U., TOUROVSKY, A., The 200 MeV proton therapy project at the Paul Scherrer Institute: Conceptual design and practical realization, *Med Phys* 22 (1995) 37-53.
- [108] KOEHLER, A.M., Dosimetry of proton beams using small diodes, *Radiat. Res. Suppl* 7 (1967) 53.
- [109] KANAI, T., KAWACHI, K., KUMAMOTO, Y., OGAWA, H., YAMADA, T., MATSUZAWA, H., INADA, T., Spot scanning system for proton radiotherapy, *Med. Phys.* 7 (1980) 365.
- [110] JONES, D.T.L., Development of a horizontal proton beam facility, Annual Report NAC/AR/91, NAC, Cape Town (1991).
- [111] VERHEY, L., KOELHER, A.M., MCDONALD, J.C., GOITEIN, M., MA, I.-C., SCHNEIDER, R.J., WAGNER, M., The determination of the absorbed dose in a proton beam for purposes of charged-particles radiation therapy, *Radiat. Res.* 79 (1979) 34-54.
- [112] VYNCKIER, S., MEULDERS, J.P., ROBERT, P., WAMBERSIE, A., The proton therapy program at the cyclotron Cyclone of Louvain-la-Neuve (first dosimetric results), *J. Eur. Radiother.* 5 (1984) 245-247.
- [113] AAPM AMERICAN ASSOCIATION OF PHYSICISTS IN MEDICINE, Task Group 20: Protocol for heavy charged-particle therapy beam dosimetry, Report 16, New York: AAPM (1986).
- [114] VYNCKIER, S., BONNETT, D.E., JONES, D.T.L., Code of practice for clinical proton dosimetry, *Radiother. Oncol.* 20 (1991) 53-63.
- [115] VYNCKIER, S., BONNETT, D.E., JONES, D.T.L., Supplement to the code of practice for clinical proton dosimetry, *Radiother. Oncol.* 32 (1994) 174-179.
- [116] ICRU INTERNATIONAL COMMISSION ON RADIATION UNITS AND MEASUREMENTS, Clinical proton dosimetry, Part I: beam production, beam delivery and measurement of absorbed dose, ICRU Report 59, Bethesda, MD: ICRU (1999).

- [117] PALMANS, H., VERHAEGEN, F., Effects of fluence perturbation on cavity dose response in clinical proton beams (Monte-Carlo study), *Phys. Med. Biol.* 43 (1998) 65-89.
- [118] ICRU INTERNATIONAL COMMISSION ON RADIATION UNITS AND MEASUREMENTS, Stopping Powers and Ranges for Protons and Alpha Particles, ICRU Report 49, Bethesda, MD: ICRU (1993).
- [119] LYMAN, J.T., "Computer modelling of heavy charged particle beams", in: Pion and Heavy Ion Radiotherapy: Pre-Clinical and Clinical Studies, Elsevier North Holland (1983) 139-147.
- [120] KANAI, T., FURUSAWA, Y., FUKUTSU, K., ITSUKAICHI, H., EGUCHI-KASAI, K., OHARA, H., Irradiation of mixed beam and design of spread-out Bragg peak for heavy-ion radiotherapy, *Radiat. Res.* 147 (1997) 78-85.
- [121] KANAI, T., ENDO, M., MINOHARA, S., MIYAHARA, N., KOYAMA-ITO, H., TOMURA, H., MATSUFUJI, N., FUTAMI, Y., FUKUMURA, A., HIRAOKA, T., FURUSAWA, Y., ANDO, K., SUZUKI, M., SOGA, F., KAWACHI, K., Biophysical characteristics of HIMAC clinical irradiation system for heavy-ion radiation therapy, *Int. J. Radiat. Oncol. Biol. Phys.* 44 (1999) 201-210.
- [122] BROERSE, J.J., LYMAN, L.T., ZOETELIEF, J., "Dosimetry of external beams of nuclear particles", in: The Dosimetry of Ionizing Radiation Vol.1 (Kase, K.R., Bjärngard, B.E., Attix, F.H.,eds.), Academic Press, New York (1987) 229-290.
- [123] HARTMANN, G.H., JÄKEL, O., HEEG, P., KARGER, C.P., KRIESSBACH, A., Determination of water absorbed dose in a carbon ion beam using thimble ionization chambers, *Phys. Med. Biol.* 44 (1999) 1193-1206.
- [124] FUKUMURA, A., HIRAOKA, T., OMATA, K., TAKESHITA, M., KAWACHI, K., KANAI, T., MATSUFUJI, N., TOMURA, H., FUTAMI, Y., KAIZUKA, Y., HARTMANN, G.H., Carbon beam dosimetry intercomparison at HIMAC, *Phys Med Biol* 43 (1998) 3459 - 3463.
- [125] LLACER, J., TOBIAS, C.A., HOLLEY, W.R., KANAI, T., On-line characterization of heavy-ion beams with semiconductor detectors, *Med. Phys.* 11 (1984) 266-278.
- [126] SCHALL, I., SCHARDT, D., GEISSEL, H., IRNICH, H., KANKELEIT, E., KRAFT, G., MAGEL, A., MOHAR, M.F., MUENZENBERG, G., NICKEL, F., SCHEIDENBERGER, C., SCHWAB, W., Charge-changing nuclear reactions of relativistic light-ion beams ($5 \leq Z \leq 10$) passing through thick absorbers, *Nucl. Instrum. Methods Phys. Res. B* 117 (1996) 221-234.
- [127] MATSUFUJI, N., TOMURA, H., FUTAMI, Y., YAMASHITA, H., FUKUMURA, A., KANAI, T., HIGASHI, A., AKAGI, T., KOMAMI, H., KOHNO, T., "Energy distribution of projectile fragment particles in heavy ion therapeutic beam", Nuclear Data (Proc Symp. Ibaragi, 1997), Report JAERI-Conf 98-003 (1998) 101-106.
- [128] BOAG, J.W., "Ionization Chambers", in: The Dosimetry of Ionizing Radiation Vol.2 (Kase, K.R., Bjärngard, B.E., Attix, F.H.,ed.), Academic Press, New York (1987) 169-243.
- [129] NIATEL, M.T., PERROCHE-ROUX, A.M., BOUTILLON, M., Two determinations of W for electrons in dry air, *Phys Med Biol* 30 (1985) 67-75.
- [130] CCEMRI(I) COMITÉ CONSULTATIF DES LES ETALONS DE MESURE DES RAYONNEMENTS IONISANTS (SECTION I), Effect of a change of stopping-power values on the W values recommended by ICRU for electrons in dry air, CCEMRI(I)/85-8, Bureau International des Poids et Mesures, Sevrès (1985).
- [131] BOUTILLON, M., PERROCHE-ROUX, A.M., Re-evaluation of the W for electrons in dry air, *Phys Med Biol* 32 (1987) 213-219.
- [132] JOHANSSON, K.A., MATTSSON, L.O., LINDBORG, L., SVENSSON, H., "Absorbed-dose determination with ionization chambers in electron and photon beams having energies between 1 and 50 MeV", National and International Standardization of Radiation Dosimetry (Proc Symp. Atlanta, 1977), Vol. 2, IAEA, Vienna (1978) 243-270.
- [133] ALMOND, P.R., SVENSSON, H., Ionization chamber dosimetry for photon and electron beams Theoretical considerations, *Acta Radiol. Ther. Phys. Biol.* 16 (1977) 177.

- [134] GILLIN, M.T., KLINE, R.W., NIROOMAND-RAD, A., GRIMM, D.F., The effect of thickness of the waterproofing sheath on the calibration of photon and electron beams, *Med. Phys.* 12 (1985) 234-236.
- [135] HANSON, W.F., DOMINGUEZ-TINOCO, J.A., Effects of plastic protective caps on the calibration of therapy beams in water, *Med. Phys.* 12 (1985) 243-248.
- [136] LEMPERT, G.D., NATH, R., SCHULZ, R.J., Fraction of ionization from electrons arising in the wall of an ionization chamber, *Med. Phys.* 10 (1983) 1-3.
- [137] NAHUM, A.E., Perturbation effects in dosimetry, Report ICR-PHYS-1/94, Joint Department of Physics, Institute of Cancer Research and Royal Marsden Hospital, Sutton, Surrey SM2 5PT, U.K. (1994).
- [138] KOSUNEN, A., JÄRVINEN, H., SIPILÄ, P., "Optimum calibration of NACP type plane parallel ionization chambers for absorbed dose determination in low energy electron beams", Measurement Assurance in Dosimetry (Proc Symp. Vienna, 1993), IAEA, Vienna (1994) 505-513.
- [139] ROGERS, D.W.O., Calibration of parallel-plate chambers: resolution of several problems by using Monte Carlo calculations, *Med. Phys.* 19 (1992) 889-899.
- [140] MA, C.M., NAHUM, A.E., Effect of the size and composition of the central electrode on the response of cylindrical ionisation chambers in high-energy photon and electron beams, *Phys. Med. Biol.* 38 (1993) 267-290.
- [141] PALM, Å., MATTSSON, O., Experimental study on the influence of the central electrode in Farmer-type ionization chambers, *Phys. Med. Biol.* 44 (1999) 1299-1308.
- [142] MATTSSON, L.O., Application of the water calorimeter, Fricke dosimeter and ionization chamber in clinical dosimetry, Doctoral Thesis, Univ of Gothenburg (1984).
- [143] ANDREO, P., Dosimetry of high-energy photon beams. Present status and future prospects for the data used in ionization chamber dosimetry, Report RI 1991-03, Radiation Physics Department, University of Stockholm (1991).
- [144] ANDREO, P., "Improved calculations of stopping-power ratios and their correlation with the quality of therapeutic photon beams", Measurement Assurance in Dosimetry (Proc Symp. Vienna, 1993), Vienna: IAEA (1994) 335-359.
- [145] SEUNTJENS, J.P., ROSS, C.K., SHORTT, K.R., ROGERS, D.W.O., Absorbed-dose beam quality conversion factors for cylindrical chambers in high-energy photon beams, *Med. Phys.* 27 (2000) 2763-2779.
- [146] HARDER, D., "Energiespektren schneller Elektronen in verschiedenen Tiefen", Symposium on High Energy Electrons-Montreux, 1964 (Proc Symp. Berlin), Springer-Verlag (1965) 26-33.
- [147] ROGERS, D.W.O., "Fundamentals of dosimetry based on absorbed-dose standards", in: Teletherapy Physics, Present and Future (Palta, J.R., Mackie, T.R., ed.), AAPM, Washington, DC (1996) 319-356.
- [148] ANDREO, P., BRAHME, A., Mean energy in electron beams, *Med. Phys.* 8 (1981) 682-687.
- [149] HUQ, M.S., YUE, N., SUNTHARALINGAM, N., Experimental determination of fluence correction factors at depths beyond d_{max} for a Farmer type cylindrical ionization chamber in clinical electron beams, *Med. Phys.* 24 (1997) 1609-1613.
- [150] WILLIAMS, A.J., MCEWEN, M.R., DUSAUTOY, A.R., A Calculation of the water to graphite perturbation factor ratios for the NACP type 02 ionisation chamber using Monte Carlo techniques, Report CIRM 13, NPL, Teddington (1998).
- [151] MATTSSON, L.O., JOHANSSON, K.A., SVENSSON, H., Calibration and use of plane-parallel ionization chambers for the determination of absorbed dose in electron beams, *Acta Radiol Oncol* 20 (1981) 385.
- [152] MEDIN, J., ANDREO, P., PETRA: a Monte Carlo code for the simulation of proton and electron transport in water, Report MSF 1997-01, Radiation Physics Department, University of Stockholm (1997).

- [153] MEDIN, J., ANDREO, P., Monte Carlo calculated stopping-power ratios water/air for clinical proton dosimetry (50-250 MeV), *Phys Med Biol* 42 (1997) 89-105.
- [154] MÜLLER, J.W., Possible advantages of a robust evaluation of comparisons, Report BIPM-95/2, BIPM, Sevres (France) (1995).
- [155] MÜLLER, J.W., Work carried out for the development of this Code of Practice, BIPM, Sevres (France) (1999). See also "Weighted medians", Report BIPM-2000/6, BIPM, Sevres (France) (2000)
- [156] PRESS, W.H., FLANNERY, B.P., TEUKOLSKY, S.A., VETTERLING, W.T., "Numerical Recipes. The Art of Scientific Computing", Cambridge University Press, New York (1986).
- [157] PALMANS, H., VERHAEGEN, F., DENIS, J.-M., VYNCKIER, S., THIERENS, H., Experimental study of perturbation correction factors for ionization chambers in a 75 MeV clinical proton beam, *Radioth. Oncol.* 51 Suppl 1 (1999) S39.
- [158] SALAMON, M.H., A range-energy program for relativistic heavy ions in the region $1 < E < 3000$ MeV/amu, LBL Report 10446, LBL, Berkeley (1980).
- [159] HIRAOKA, T., BICHSEL, H., Stopping powers and ranges for heavy ions, *Jpn. J. Med. Phys.* 15 (1995) 91-100.
- [160] KANAI, T., KOHNO, T., MINOHARA, S., SUDOU, M., TAKADA, E., SOGA, F., KAWACHI, K., FUKUMURA, A., Dosimetry and measured differential w value of air for heavy ions, *Radiat. Res.* 135 (1993) 293-291.
- [161] HIRAOKA, T., KAWASHIMA, K., HOSHINO, K., FUKUMURA, A., Estimation of w-value for particle beams in several gases, *Jpn. Radiol. Phys.* 9 (1989) 143-152.
- [162] STEPHENS, L.D., THOMAS, R.H., KELLY, L.S., A measurement of the average energy required to create an ion pair in nitrogen by 250 MeV/amu C⁶⁺ ions, *Phys. Med. Biol.* 21 (1976) 570-576.
- [163] THOMAS, R.H., LYMAN, J.T., DE CASTRO, T.M., A measurement of the average energy required to create an ion pair in nitrogen by high-energy ions, *Radiat. Res.* 82 (1980) 1-12.
- [164] SCHIMMERLING, W., KAPLAN, S., SUBRAMANIAN, T.S., MCDONALD, W.J., GABOR, G., SADOFF, A., ALPEN, E., "Measurements of W for high energy heavy ions", 8th Symp Microdosimetry (Proc Symp. Juelich, Germany) (1982) 311-321.
- [165] KOSUNEN, A., ROGERS, D.W.O., Beam quality specification for photon beam dosimetry, *Med. Phys.* 20 (1993) 1181-1188.
- [166] NACP NORDIC ASSOCIATION OF CLINICAL PHYSICS, Procedures in radiation therapy dosimetry with 5 to 50 MeV electrons and roentgen and gamma rays with maximum photon energies between 1 and 50 MeV, *Acta Radiol. Ther. Phys. Biol.* 11 (1972) 603-624.
- [167] BRITISH INSTITUTE OF RADIOLOGY, Central axis depth dose data for use in Radiotherapy, Brit. J. Radiol. Supplement no. 11, The British Institute of Radiology, London (1972).
- [168] LARIVIERE, P.D., The quality of high-energy X-ray beams, *Brit. J. Radiol.* 62 (1989) 473-481.
- [169] HANSON, W.F., KENNEDY, P., Best fit published depth-dose data and RPC measured output factors and in-air off-axis factors, Internal Report RPC TX 1992, Radiological Physics Center (RPC), Houston (1992).
- [170] ANDREO, P., "Current status and future trends of the dosimetry of high-energy photon and electron beams", VII Congreso Nacional de Física Médica, Sociedad Española de Física Médica (Proc Symp. Oviedo, Spain), Sociedad Española de Física Médica (1989) 11-43.
- [171] ROGERS, D.W.O., YANG, C.L., Corrected relationship between %dd(10)_x and stopping-power ratios, *Med. Phys.* 26 (1999) 538-540.
- [172] ROSS, C.K., SHORTT, K.R., ROGERS, D.W.O., DELAUNAY, F., "A test of TPR_{20,10} as a beam quality specifier for high energy photon beams", Measurement Assurance in Dosimetry (Proc Symp. Vienna, 1993), Vienna: IAEA (1994)
- [173] LI, X.A., ROGERS, D.W.O., Reducing electron contamination for photon-beam-quality specification, *Med. Phys.* 21 (1994) 791-798.

- [174] ROGERS, D.W.O., Correcting for electron contamination at dose maximum in photon beams, *Med. Phys.* 26 (1999) 533-537.
- [175] NELSON, W.R., HIRAYAMA, H., ROGERS, D.W.O., The EGS4 Code System, SLAC-265, Stanford Linear Accelerator Center, Stanford, CA (1985).
- [176] SEUNTJENS, J.P., SHORT, K.R., ROSS, C.K., MA, C.M., ROGERS, D.W.O., Measurements of beam quality correction factors k_Q for cylindrical ionisation chambers in high energy photon beams, *Med. Phys.* 23 (1996) 1071.
- [177] PALMANS, H., MONDELAERS, W., THIERENS, H., Absorbed dose beam quality correction factors k_Q for the NE2571 chamber in a 5 MV and a 10 MV photon beam, *Phys. Med. Biol.* 44 (1999) 647-663.
- [178] ICRU INTERNATIONAL COMMISSION ON RADIATION UNITS AND MEASUREMENTS, Clinical Dosimetry, ICRU Report 10d, ICRU, Bethesda, MD (1962).
- [179] MOHAN, R., CHUI, C., LIDOFKY, L., Energy and Angular Distributions of Photons from Medical Linear Accelerators, *Med. Phys.* 12 (1985) 592-597.
- [180] HUQ, M.S., HOSSAIN, M., ANDREO, P., A comparison of the AAPM TG51 protocol and the IAEA absorbed-dose-to-water based Code of Practice for dosimetry calibration of high energy photon beams, *Med. Phys.* 26 (1999) 1153.
- [181] CIPM COMITÉ INTERNATIONAL DES POIDS ET MEASURES, Rapport du Groupe de Travail sur l'expression des incertitudes au Comité International des Poids et Mesures, *Procès-Verbaux* 49 (1981) A1-A12.
- [182] PALM, Å., MATTSSON, O., ANDREO, P., Calibration of plane-parallel chambers and determination of p_{wall} for the NACP and Roos chambers for ^{60}Co -ray beams, *Phys Med Biol* 45 (2000) 971-981.

IAEA MEETINGS RELATED TO THIS PUBLICATION

Advisory Group Meetings

Seventh Meeting of the Standing Advisory Group "SSDL Scientific Committee",
Vienna, 30 September - 4 October 1996.

Research Co-ordinated Meetings (CRP E2.40.09)

Rome, 3-7 November 1997; Brussels, 3-7 May 1999

Consultants meetings

Vienna, 25-28 November 1996; 25-29 May 1998.

RECENT IAEA PUBLICATIONS ON RADIATION DOSIMETRY AND MEDICAL RADIATION PHYSICS

- 1999 Calibration of Brachytherapy Sources: Guidelines on Standardized Procedures for the Calibration of Brachytherapy Sources at Secondary Standard Dosimetry Laboratories (SSDLs) and Hospitals (**IAEA-TECDOC-1079**).
- 1999 Techniques for High-Dose Dosimetry in Industry, Agriculture and Medicine, Proceedings of an International Symposium, Vienna, 2–5 November 1998 (**IAEA-TECDOC-1070**).
- 1999 SSDL Network Charter: IAEA/WHO Network of Secondary Standard Dosimetry Laboratories (**IAEA/WHO/SSDL/99**).
- 1998 Design and Implementation of a Radiotherapy Programme: Clinical, Medical Physics, Radiation Protection and Safety Aspects (**IAEA-TECDOC-1040**).
- 1998 Determinación de la Dosis Absorbida en Haces de Fotones y Electrones, Código de Práctica Internacional (**OIEA Colección de Informes Tecnicos No. 277, Segunda Edición**). This supersedes the first Spanish edition of 1990.
- 1998 Accidental Overexposure of Radiotherapy Patients in San José, Costa Rica. IAEA Special Publication Series (**STI/PUB/1027**).
- 1997 Quality Assurance in Radiotherapy, Proceedings of a Joint IAEA–ISRO Working Meeting on National Programmes, 1995 (**IAEA-TECDOC-989**).
- 1997 The Use of Plane Parallel Ionization Chambers in High Energy Electron and Photon Beams: An International Code of Practice for Dosimetry (**IAEA Technical Reports Series No. 381**).
- 1997 Absorbed Dose Determination in Photon and Electron Beams: An International Code of Practice (**IAEA Technical Reports Series No. 277, Second Edition**). This supersedes the first edition of 1987.
- 1996 Review of Data and Methods Recommended in the International Code of Practice IAEA Technical Reports Series No. 277 for Absorbed Dose Determination in Photon and Electron Beams (**IAEA-TECDOC-897**).
- 1996 Radiation Dose in Radiotherapy from Prescription to Delivery, Proceedings of an IAEA Seminar in Rio de Janeiro, 1994 (**IAEA-TECDOC-896**).
- 1994 Calibration of Dosimeters used in Radiotherapy: A Manual sponsored by the IAEA and WHO (**IAEA Technical Reports Series No. 374**). This supersedes IAEA Technical Reports Series No. 185.
- 1994 Radiation Dose in Radiotherapy from Prescription to Delivery, Proceedings of an IAEA Seminar in Leuven, 1991 (**IAEA-TECDOC-734**).
- 1994 Measurement Assurance in Dosimetry, Proceedings of a Symposium, Vienna, 24–27 May 1993 (**IAEA-STI/PUB/930**).