



INVESTIGATION OF AN ACCIDENTAL EXPOSURE OF RADIOTHERAPY PATIENTS IN PANAMA

Report of a Team of Experts, 26 May–1 June 2001



INTERNATIONAL ATOMIC ENERGY AGENCY

INVESTIGATION OF AN
ACCIDENTAL EXPOSURE OF
RADIOTHERAPY PATIENTS
IN PANAMA

Report of a Team of Experts
26 May–1 June 2001

The following States are Members of the International Atomic Energy Agency:

AFGHANISTAN	GHANA	PAKISTAN
ALBANIA	GREECE	PANAMA
ALGERIA	GUATEMALA	PARAGUAY
ANGOLA	HAITI	PERU
ARGENTINA	HOLY SEE	PHILIPPINES
ARMENIA	HUNGARY	POLAND
AUSTRALIA	ICELAND	PORTUGAL
AUSTRIA	INDIA	QATAR
AZERBAIJAN, REPUBLIC OF	INDONESIA	REPUBLIC OF MOLDOVA
BANGLADESH	IRAN, ISLAMIC REPUBLIC OF	ROMANIA
BELARUS	IRAQ	RUSSIAN FEDERATION
BELGIUM	IRELAND	SAUDI ARABIA
BENIN	ISRAEL	SENEGAL
BOLIVIA	ITALY	SIERRA LEONE
BOSNIA AND HERZEGOVINA	JAMAICA	SINGAPORE
BRAZIL	JAPAN	SLOVAKIA
BULGARIA	JORDAN	SLOVENIA
BURKINA FASO	KAZAKHSTAN	SOUTH AFRICA
CAMBODIA	KENYA	SPAIN
CAMEROON	KOREA, REPUBLIC OF	SRI LANKA
CANADA	KUWAIT	SUDAN
CENTRAL AFRICAN REPUBLIC	LATVIA	SWEDEN
CHILE	LEBANON	SWITZERLAND
CHINA	LIBERIA	SYRIAN ARAB REPUBLIC
COLOMBIA	LIBYAN ARAB JAMAHIRIYA	THAILAND
COSTA RICA	LIECHTENSTEIN	THE FORMER YUGOSLAV REPUBLIC OF MACEDONIA
COTE D'IVOIRE	LITHUANIA	TUNISIA
CROATIA	LUXEMBOURG	TURKEY
CUBA	MADAGASCAR	UGANDA
CYPRUS	MALAYSIA	UKRAINE
CZECH REPUBLIC	MALI	UNITED ARAB EMIRATES
DEMOCRATIC REPUBLIC OF THE CONGO	MALTA	UNITED KINGDOM OF GREAT BRITAIN AND NORTHERN IRELAND
DENMARK	MARSHALL ISLANDS	UNITED REPUBLIC OF TANZANIA
DOMINICAN REPUBLIC	MAURITIUS	UNITED STATES OF AMERICA
ECUADOR	MEXICO	URUGUAY
EGYPT	MONACO	UZBEKISTAN
EL SALVADOR	MONGOLIA	VENEZUELA
ESTONIA	MOROCCO	VIET NAM
ETHIOPIA	MYANMAR	YEMEN
FINLAND	NAMIBIA	YUGOSLAVIA
FRANCE	NETHERLANDS	ZAMBIA
GABON	NEW ZEALAND	ZIMBABWE
GEORGIA	NICARAGUA	
GERMANY	NIGER	
	NIGERIA	
	NORWAY	

The Agency's Statute was approved on 23 October 1956 by the Conference on the Statute of the IAEA held at United Nations Headquarters, New York; it entered into force on 29 July 1957. The Headquarters of the Agency are situated in Vienna. Its principal objective is "to accelerate and enlarge the contribution of atomic energy to peace, health and prosperity throughout the world".

© IAEA, 2001

Permission to reproduce or translate the information contained in this publication may be obtained by writing to the International Atomic Energy Agency, Wagramer Strasse 5, P.O. Box 100, A-1400 Vienna, Austria.

Printed by the IAEA in Austria
August 2001
STI/PUB/1114

INVESTIGATION OF AN
ACCIDENTAL EXPOSURE OF
RADIOTHERAPY PATIENTS
IN PANAMA

Report of a Team of Experts
26 May–1 June 2001

INTERNATIONAL ATOMIC ENERGY AGENCY
VIENNA, 2001

VIC Library Cataloguing in Publication Data

Investigation of an accidental exposure of radiotherapy patients in Panama /
report of a Team of Experts, 26 May–1 June 2001. — Vienna : International
Atomic Energy Agency, 2001.

p. ; 24 cm.

STI/PUB/1114

ISBN 92-0-101701-4

Includes bibliographical references.

1. Radiotherapy — Accidents — Panama. Radiation — Physiological
effect. I. International Atomic Energy Agency.

VICL

01-00270

FOREWORD

Early in 2001, serious accidental exposures involving patients undergoing radiotherapeutic procedures were discovered in Panama. The Government of Panama requested assistance from the IAEA under the terms of the Convention on Assistance in the Case of a Nuclear Accident or Radiological Emergency. The IAEA immediately notified the World Health Organization (WHO) and assembled and sent to Panama a team of senior experts from France, Japan, the USA and the IAEA, as well as a senior expert from the Russian Federation nominated by WHO. The expert team was requested to ensure that the “radiation source(s) involved in the accident was (were) in a safe and secure condition”; to “evaluate the doses incurred by the affected patients”; undertake a medical evaluation of the affected patients’ prognosis and treatment; and to “identify issues on which the IAEA could offer to provide and/or co-ordinate assistance with a view to minimizing the consequences of the accident”. In addition, the Minister of Health of Panama had requested assistance from the Pan American Health Organization (PAHO/WHO), and a PAHO officer supported the expert team. This report contains the expert team’s assessment of the accidental exposure.

The IAEA is very grateful to the Government of Panama for giving it the opportunity to assist in the aftermath of the accidental exposure described in this report and, as a consequence, to draw valuable lessons that can be shared with the international community worldwide.

In particular, the IAEA wishes to express its thanks to the Panamanian Minister of Health and the Director General of Public Health, to the Director of the Instituto Oncológico Nacional (ION), to the Department of Radiation Health of the Social Security Complex Hospital and to the staff of all the Panamanian organizations which collaborated with the expert team.

The IAEA is also very grateful to the members of the expert team for their dedication in carrying out their task and for their contribution to the development and review of this report. The IAEA wishes to express its thanks to: the Department of Radiology, School of Medicine, of the University of New Mexico, Albuquerque, USA; to the Département de Radiothérapie of the Institut Curie, Paris, and to the Institut de Protection et de Sûreté Nucléaire, Fontenay-aux-Roses, France; the Research Centre for Radiation Emergency Medicine of the National Institute of Radiological Sciences, Chiba, Japan; and to the Hematologic Department of the Russian Scientific Research Centre, Moscow, (a collaborating centre of WHO) for making their staff available for this mission. The IAEA is also grateful to PAHO for its readiness to collaborate fully with the expert team.

The members of the team, as well as the names of the supporting experts, are given below:

TEAM OF EXPERTS

- Akashi, M. Research Center for Radiation Emergency Medicine of the National Institute of Radiological Sciences, Chiba, Japan
- Cosset, J.-M. Section Médicale et Hospitalière, Département de Radiothérapie, Service B, Institut Curie, Paris, France; Member of Committee 3 of the International Commission on Radiological Protection (ICRP)
- Gourmelon, P. Commissariat à l'Énergie Atomique, Centre d'Études Nucléaires de Fontenay-aux-Roses, Institut de Protection et de Sécurité Nucléaire, Fontenay-aux-Roses, France
- Konchalovsky, M.V. Hematologic Department of the Scientific Research Center of the Russian Federation, Moscow, Russian Federation
(*representing WHO*)
- Mettler, F.A., Jr., Department of Radiology, The University of New Mexico, School of Medicine, Albuquerque, New Mexico, United States of America; Delegate of USA to UNSCEAR; Member of the Main Commission and Chairman of Committee 3 of the ICRP
(*Chairman*)
- Ortiz López, P. Radiation Safety Section, Division of Radiation and Waste Safety, International Atomic Energy Agency; Member of Committee 3 of the ICRP
(*Team co-ordinator*)
- Vatnitsky, S. Dosimetry and Medical Radiation Physics Section, Division of Human Health, International Atomic Energy Agency

SUPPORTING EXPERTS

Pan American Health Organization

Borrás, C. Program of Essential Drugs and Technology,
Division of Health Systems and Services Development,
Pan American Health Organization,
Washington, D.C., United States of America

Panamanian Government

Arenas, E. Médica Epidemióloga, Ministerio de Salud (MINSa)
Barés, J.P. Director General, Instituto Oncológico Nacional (ION)
Gibbs, E. Jefe del Departamento de Salud Radiológica, Caja de
Seguro Social (CSS)
López, R.I. Médico Oncólogo del ION
Morales, E. Director General de Salud, MINSa
Pinzón, N. Subdirectora del ION

Panamanian experts

Bedoya, R. Técnico de Salud Radiológica CSS
Bolaños, V. Técnico de Salud Radiológica CSS
De Infante, M. Técnico de Salud Radiológica CSS
Douglas, A. Técnico de Salud Radiológica CSS
Fernández, M. Técnico de Salud Radiológica CSS
Fisher, V. Técnico de Salud Radiológica CSS
Scotland, E. Técnico de Salud Radiológica CSS
Terán, L.A. Técnico de Salud Radiológica CSS
Tuñón, E. Técnico de Salud Radiológica CSS

EDITORIAL NOTE

This report is based on information made available by or through the Panamanian authorities.

The report does not address questions of responsibility, legal or otherwise, for acts or omissions on the part of any person.

Although great care has been taken to maintain the accuracy of information contained in this report, neither the IAEA nor its Member States assume any responsibility for consequences which may arise from its use.

The use of particular designations or countries or territories does not imply any judgement by the publisher, the IAEA, as to the legal status of such countries or territories, of their authorities and institutions or of the limitation of their boundaries.

The mention of names of specific companies or products (whether or not indicated as registered) does not imply any intention to infringe proprietary rights, nor should it be construed as an endorsement or recommendation on the part of the IAEA.

Material made available by persons who are in contractual relation with governments is copyrighted by the IAEA, as publisher, only to the extent permitted by the appropriate national regulations.

CONTENTS

EXECUTIVE SUMMARY	1
The accidental exposure	1
Lessons and recommendations	2
1. INTRODUCTION	7
1.1. Background	7
1.2. Objectives	9
1.3. Scope	9
1.4. Structure	9
2. BACKGROUND INFORMATION	10
2.1. Radiotherapy departments in Panama	10
2.2. The Radiotherapy Department at the Instituto Oncológico Nacional	10
2.2.1. External beam radiotherapy	11
2.2.2. Brachytherapy	13
2.3. Treatment planning system	14
2.4. Radiation protection infrastructure and regulatory control	15
2.4.1. Authorization of the Radiotherapy Department	16
2.5. History of recent audits of the Radiotherapy Department	16
2.5.1. Audit in February 1999	16
2.5.2. Audit in February 2001	18
2.5.3. Results of IAEA/WHO TLD postal dose quality audits performed at the ION	19
3. THE ACCIDENTAL EXPOSURE	19
3.1. Initiating event	19
3.2. Discovery of the problem	23
4.. RESPONSE TO THE ACCIDENTAL EXPOSURE	24
4.1. Actions taken upon discovery of the error	24
4.2. Response from the IAEA	25

5.	DOSE ASSESSMENT	28
5.1.	Introduction	28
5.2.	Scope of the dosimetric evaluation	29
5.3.	Comparison of the dosimetry systems and beam calibration	31
5.3.1.	Dosimetry system intercomparison	31
5.3.2.	⁶⁰ Co beam calibration	32
5.3.3.	Variation of absorbed dose with field size	32
5.3.4.	Depth dose data	33
5.3.5.	Wedge transmission	33
5.3.6.	Verification of dose delivery	33
5.4.	Patient doses	34
5.4.1.	Assessment of doses from irradiation with external beams ..	34
5.4.2.	Consideration of brachytherapy treatments	35
5.4.3.	Doses equivalent to treatments of 2 Gy per fraction	35
5.4.4.	Other patients treated in the same period	46
6.	TEST OF THE COMPUTER SOFTWARE USING DIFFERENT APPROACHES FOR DATA ENTRY	47
6.1.	Instructions and warnings	47
6.2.	Tests performed	48
7.	MEDICAL ASSESSMENT	60
7.1.	Background information on radiation effects in humans	60
7.2.	Basic radiotherapy principles relevant to this accidental exposure ..	61
7.3.	Fractionation of radiation exposure	62
7.4.	Adverse effects	62
7.5.	Spectrum of overexposures in this event	63
7.6.	Complicating factors in the evaluation of this event	65
7.7.	Results of the medical team's investigation	65
7.7.1.	Surviving patients	72
7.7.2.	Deceased patients	75
7.7.3.	Sequence of events leading to death	78
8.	FINDINGS AND CONCLUSIONS OF THE TEAM, AND LESSONS TO BE LEARNED	79
8.1.	Operating organization: Radiotherapy departments	80
8.1.1.	Quality assurance and radiotherapy	80

8.1.2. Treatment planning systems as a safety issue	81
8.1.3. Manual calculation check of the computer calculated plan . .	81
8.1.4. Changes in procedures	81
8.1.5. Workload and team integration	82
8.1.6. Observation of unusual reactions of patients	82
8.1.7. In vivo dosimetry	83
8.1.8. Local advice from the manufacturer/supplier.	83
8.2. National authorities	83
8.2.1. Quality assurance	83
8.2.2. Communication between regulators and users of radiation .	84
8.3. Equipment manufacturers and suppliers	84
8.3.1 Software in treatment planning	84
8.4. The medical community	85
8.4.1. Findings	85
8.4.2. Recommendation on patient care and follow-up	85
 ANNEX I. TERMINATION REPORT TO THE CONTACT POINTS	 87
 ANNEX II. LITERATURE REVIEW OF RADIATION EFFECTS IN PERTINENT TISSUES IN THIS ACCIDENTAL EXPOSURE . .	 89
 Skin	 89
Small intestine	90
Colon, sigmoid and rectum	92
Bladder	93
Uterus	95
Vagina	96
Prostate and seminal vesicles	97
Penis, urethra and scrotum	97
 ANNEX III. DATA ON INDIVIDUAL PATIENTS INVOLVED IN THIS ACCIDENTAL EXPOSURE	 99
 REFERENCES	 111
CONTRIBUTORS TO DRAFTING AND REVIEW	115

EXECUTIVE SUMMARY

THE ACCIDENTAL EXPOSURE

The Instituto Oncológico Nacional (ION) in Panama provides treatment for cancer patients using radiotherapy. As is common practice in most radiotherapy departments, the ION uses blocks of shielding material to modify the shapes of the radiation beams to protect normal tissue, including critical structures, during treatment.

A computerized treatment planning system (TPS) was used by the ION to calculate the resulting dose distributions and determine treatment times. The data for each shielding block should be entered into the TPS separately. The TPS allows a maximum of four shielding blocks per field to be taken into account when calculating treatment times and dose distributions.

According to information provided to the IAEA Team, in order to satisfy the request of a radiation oncologist to include five blocks in the field, in August 2000 the method of digitizing¹ shielding blocks was changed. It was found that it was possible to enter data into the TPS for multiple shielding blocks together as if they were a single block², thereby apparently overcoming the limitation of four blocks per field.

As was found later, although the TPS accepted entry of the data for multiple shielding blocks as if they were a single block, at least one of the ways in which the data were entered the computer output indicated a treatment time substantially longer than it should have been. The result was that patients received a proportionately higher dose than that prescribed. The modified treatment protocol was used for 28 patients, who were treated between August 2000 and March 2001 for prostate cancer and cancer of the cervix.

Several characteristics of the TPS made it relatively easy for the error to occur:

- It is questionable whether the information in the instructions is sufficiently clear to guide the user in detail on the way in which the blocks should be digitized;

¹ 'Digitizing the blocks' is a common expression for the process of entering the co-ordinates of the relevant points of the contours of the blocks' cross-sections into the computer, by means of a device called digitizer, which is part of the TPS.

² The phrase "enter data into the TPS for multiple shielding blocks together as if they were a single block" means in this report that the block co-ordinates were digitized by following the inner boundaries of the blocks, describing a loop and then following the outer boundaries describing another loop (as explained in Sections 3 and 6). At the end, the transmission factor is entered once for all blocks.

- Several different ways of digitizing the blocks were accepted by the computer;
- There was no warning on the computer screen when blocks were digitized in an unacceptable way, i.e. any way that is different from the one prescribed in the manual;
- When blocks were digitized incorrectly, the TPS produced a diagram which was the same as that produced when data were entered correctly, thereby giving the impression that the calculational results were correct.

The modified protocol was used without a verification test, i.e. a manual calculation of the treatment time for comparison with the computer calculated treatment time, or a simulation of treatment by irradiating a water phantom and measuring the dose delivered. In spite of the treatment times being about twice those required for correct treatment, the error went unnoticed. Some early symptoms of excessive exposure were noted in some of the irradiated patients. The seriousness, however, was not realized, with the consequence that the accidental exposure went unnoticed for a number of months. The continued emergence of these symptoms, however, eventually led to the accidental exposure being detected. This was in March 2001.

In May 2001, the Government of Panama requested assistance under the terms of the Convention on Assistance in the Case of a Nuclear Accident or Radiological Emergency. In its response, the IAEA sent a team of five medical doctors and two physicists to Panama to perform a dosimetric and medical assessment of the accidental exposure and a medical evaluation of the affected patients' prognosis and treatment. The team was complemented by a physicist from the Pan American Health Organization (PAHO), also at the request of the Government of Panama.

By the time of the mission eight patients had already died. At least five of the deaths were probably radiation related. One death was assumed to be cancer related and in two cases there was not enough information to decide the cause of death. All 20 surviving patients were examined by the medical team. Most of the injuries of these patients were related to the bowel, with a number of patients suffering persistent bloody diarrhoea, necrosis, ulceration and anaemia. About three quarters of them are expected to develop serious complications, which in some cases may ultimately prove fatal.

LESSONS AND RECOMMENDATIONS

A number of lessons and recommendations have been drawn from this accidental exposure and are given in summary form here.

The operating organization: Radiotherapy departments

Quality assurance

In radiotherapy, a single error or equipment fault can have very severe or even fatal consequences if not discovered before the radiation dose is incorrectly delivered to patients. A system that ensures detection and correction of errors before they result in incorrect dose delivery needs to be in place, i.e. a quality assurance (QA) system. Hospital managers responsible for the radiotherapy department need to put the QA system in place and ensure that it works.

Treatment planning systems

Treatment planning systems are a critical component in radiotherapy and therefore it is important to include them in the quality control procedures at radiotherapy departments. They should include verification by manual calculation of the treatment time and dose to the selected point.

Written procedures and testing of new procedures

Every step in the radiotherapy process should be reflected in the written procedures. New procedures or changes in procedures should require formal testing, approval and documentation, as part of the QA programme.

Workload and team integration

Individual and team awareness of each patient are essential to ensure that abnormal situations are noticed immediately.

Pressure due to a heavy workload, if not properly managed, can result in a reduction in quality and safety. The workload should not result in a lowering of quality and safety standards. Staff should conform to the guidance provided by standards of good practice (usually given by professional bodies) and their work should be kept under review and re-examined with regard to the workload (number of patients) and with regard to any issue that places an extra burden on them, such as the introduction of a new technique.

An integrated team approach to radiotherapy, combined with well defined individual functions and responsibilities, should be part of the design and implementation of a radiotherapy department.

Observation of unusual reactions of patients

Careful and frequent patient observation, followed up by a comprehensive examination of the possible causes of unexpected symptoms, is indispensable for the early discovery of errors and the mitigation of their consequences. Observation of unexpected symptoms should be prompt.

In vivo dosimetry

Errors in dose delivery can be detected by in vivo dosimetry, by the use of solid state detectors placed on the patients. This provides evidence that the correct dose has been delivered to a patient, and is a desirable additional level of defence in depth.³

Implementation of in vivo dosimetry requires the allocation of resources in terms of equipment, calibration of detectors, QA and, what is most important, adequate training. These requirements are difficult to meet in some countries. Nevertheless, with appropriate planning and allocation of resources, in vivo dosimetry can be implemented even in small radiotherapy departments and this is a desirable feature.

In vivo dosimetry should be promoted as far as practicable in radiotherapy departments, but proper preparation for such a programme is necessary. It requires the allocation of resources in terms of equipment, calibration of detectors, QA and proper staff training.

Request for advice from the manufacturer

For proper use of equipment co-operation between the user and the supplier is essential and should be provided for at the time the equipment is purchased.

Recommendations to national authorities

Quality assurance

A QA programme for radiotherapy should be a mandatory requirement in the regulations, and the requirement should be enforced. The protocols used should be in accordance with well proven programmes developed either at the national or regional levels.

³ Defence in depth means the application of more than a single protective measure for a given safety objective such that the objective is achieved even if one of the protective measures fails.

National authorities should promote external audits; recommendations arising from the audits should be evaluated by the QA and radiation protection committee and implementation should be closely followed up.

Communication between regulators and users of radiation

Users of radiation should understand that they share a common objective with the regulatory authority, which is safe operation, and that monitoring compliance with regulatory requirements is oriented to that objective.

Equipment manufacturers and suppliers

Software in treatment planning

Instructions and explanations which do not make clear exactly what is and what is not allowed leave open the possibility of users choosing an approach that was not tested by the manufacturer.

Software should be tested to ensure that it is as foolproof as possible. Instructions should guide the user explicitly and fully through the process, following options that are allowed and have been tested, so as to avoid users trying any other method that may not have been tested by the manufacturer. Deviation from the steps given in the instructions should be prevented by a warning inserted both in the instructions and on the computer screen display.

The medical community

Findings

Additional radiation effects will become apparent in the affected patients over the next months and years and, given the radiation doses received, the morbidity and mortality can be expected to increase. Most of the surviving patients already have serious medical problems related mainly to bowel and bladder overexposure. Most of the untoward bowel and bladder effects cannot be remedied.

Recommendation on patient care and follow-up

The following recommendations applicable to this case are also generally applicable to other accidental exposures of radiotherapy patients. With regard to the evaluation of the event leading to the overexposure:

- There should be a clinical–pathological conference between the medical examiner and the clinicians caring for the surviving patients.
- Given the internal nature of the injury, examinations that allow inspection of internal organs, such as endoscopy, should be carried out.

Patients should be made aware of the fact that:

- Appropriate nutrition is extremely important. They should be helped and informed on how to arrange for a low residue, high protein, high calorie, iron rich diet. In some cases hyperalimentation may be necessary.
- Psychological support may provide significant benefits.

The medical follow-up of the patients should take into consideration that:

- Medical care and surveillance should continue to be provided for the surviving patients. The approach should be interdisciplinary.
- Home care (rather than hospital care) programmes should be favoured whenever possible.
- Medical care should be supportive and conservative.
- Surgery of highly radiation exposed tissue is very risky and should only be performed when there are extremely strong indications.
- An autopsy is strongly recommended when, unfortunately, a patient dies.

1. INTRODUCTION

1.1. BACKGROUND

The Instituto Oncológico Nacional (ION) in Panama provides treatment for cancer patients using radiotherapy. As is common practice in most radiotherapy departments, the ION uses blocks of shielding material to modify the shapes of the radiation beams to protect normal tissue, including critical structure, during treatment. Such shielding blocks may be standard rectangular shapes or may be fabricated in the required shape and size for a particular treatment or patient. They are used, as needed, at the direction of the radiation oncologist, mainly in treatments of the head and neck region, of Hodgkin's disease and of certain diseases of the pelvic region (cancers of the prostate, cervix and colon).

A computerized treatment planning system (TPS) was used by the ION to calculate the resulting dose distributions and determine treatment times. The TPS allows a maximum of four shielding blocks per field⁴ to be taken into account when calculating treatment times and the resulting dose distributions.

According to the information provided to the IAEA Team, in order to satisfy the request of a radiation oncologist to include five blocks in the field, in August 2000 the medical physicists changed the method of entering shielding blocks in order to overcome this limitation for treatments that require more than four shielding blocks. They found that it was possible to enter data into the TPS for several shielding blocks together as if they were a single block, instead of entering them separately as was the practice for other treatments.

As was found later, the TPS accepts grouped entry of multiple shielding blocks in various ways, but at least one of these alternative ways results in an incorrect value for the calculated treatment time, a time substantially longer than it should be. When this treatment time is used, a patient receives a dose that is about twice the prescribed value.

The International Basic Safety Standards for Protection against Ionizing Radiation and for the Safety of Radiation Sources (BSS) [1] lays down the basic requirements for protection and safety, including those related to the protection of patients. These requirements include the following:

⁴ 'Treatment field' is the term used in radiotherapy to denote the direction of the beam and the size and shape of its cross-section. Treatments in the pelvic region often require multiple treatment fields (that is, irradiation from different directions).

“INVESTIGATION OF ACCIDENTAL MEDICAL EXPOSURES

II.29. Registrants and licensees shall promptly investigate any of the following incidents:

- (a) any therapeutic treatment delivered to either the wrong patient or the wrong tissue, or using the wrong pharmaceutical, or with a dose or dose fractionation differing substantially from the values prescribed by the medical practitioner or which may lead to undue acute secondary effects;
- (b) any diagnostic exposure substantially greater than intended or resulting in doses repeatedly and substantially exceeding the established guidance levels; and
- (c) any equipment failure, accident, error, mishap or other unusual occurrence with the potential for causing a patient exposure significantly different from that intended.

II.30. Registrants and licensees shall, with respect to any investigation required under para. II.29:

- (a) calculate or estimate the doses received and their distribution within the patient;
- (b) indicate the corrective measures required to prevent recurrence of such an incident;
- (c) implement all the corrective measures that are under their own responsibility;
- (d) submit to the Regulatory Authority, as soon as possible after the investigation or as otherwise specified by the Regulatory Authority, a written report which states the cause of the incident and includes the information specified in (a) to (c), as relevant, and any other information required by the Regulatory Authority; and
- (e) inform the patient and his or her doctor about the incident.”

The Government of Panama requested assistance from the IAEA under the terms of the Convention on Assistance in the Case of a Nuclear Accident or Radiological Emergency. The terms of reference of the assistance requested included the provision of medical advice on the affected patients and performing an estimation of patient doses. In parallel, the Minister of Health also requested assistance from PAHO for one of its experts to join a team of international experts selected by the IAEA. Such a team undertook this task and, in addition, performed an investigation of the accidental exposure in the terms described in the BSS. This report contains the results of that investigation.

1.2. OBJECTIVES

For a number of years, the IAEA has, upon request, provided support and assistance and conducted follow-up investigations in the event of serious accidents involving radiation sources. Reports have been published on these investigations, which have covered radiological accidents involving workers, the public, and patients receiving radiotherapy. An example of the latter was the accidental exposure in San José, Costa Rica [2]. A report on lessons to be learned from a review of a number of accidental exposures in radiotherapy has also been published [3].

The objectives of this report are to compile information about the causes and consequences of the accidental exposure at the ION, and to make recommendations about how such accidental exposures can be avoided in the future.

The information is intended for the use of national authorities such as regulatory and health institutions, health administrators and a broad range of specialists, including radiation oncologists, radiotherapy technologists, medical physicists, manufacturers, maintenance engineers and radiation protection specialists.

1.3. SCOPE

The present report describes the circumstances and events related to the accidental exposure. It describes the health effects and provides conclusions relevant to national authorities, radiotherapy departments and manufacturers of radiotherapy TPS.

1.4. STRUCTURE

Background information about the radiation protection regulations and infrastructure in Panama, the description of the radiotherapy department in which the events occurred and the TPS involved is provided in Section 2. An account of the circumstances of the event is given in Section 3. The actions taken in response to the event are described in Section 4. The evaluation of the doses received by the affected patients is given in Section 5, TPS tests are given in Section 6 and the medical evaluation of these patients is provided in Section 7. The overall findings and conclusions are given in Section 8.

Annex I contains the official Termination Report to the Contact Points identified under the Convention on Early Notification of a Nuclear Accident and the Convention on Assistance in the Case of a Nuclear Accident or Radiological Emergency. Annex II presents a literature review of the effects of high radiation doses on the tissues concerned. Annex III contains data on the individual patients involved in this accidental exposure.

2. BACKGROUND INFORMATION

2.1. RADIOTHERAPY DEPARTMENTS IN PANAMA

There are three radiotherapy departments in Panama: the Instituto Oncológico Nacional (ION), consisting of the treatment installation on Justo Arosemena Ave. and the Gorgas Hospital, and two private hospitals, the Clínica Especializada de Oncología, S.A. (CLEONSA) and the Centro Médico Paitilla. The external beam radiotherapy equipment in the three institutions is shown in Table I.

2.2. THE RADIOTHERAPY DEPARTMENT AT THE INSTITUTO ONCOLÓGICO NACIONAL

In 2000, the ION provided medical care to 44 000 patients, of which 6400 were referred to the radiotherapy department and approximately 1100 received radiotherapy treatment. The breakdown by type of treatment is shown in Table II.

The Department of Radiation Oncology has five radiation oncologists, four radiotherapy technicians, two medical physicists and one physics assistant (dosimetrist). It was originally located in the Justo Arosemena Hospital, but in 1999 it was moved to the ION in the old Gorgas Hospital, which was modified to accommodate the Radiotherapy Department.

The brachytherapy ^{137}Cs sources for manual afterloading have been located in the Gorgas Hospital since September 2000, while external beam equipment has remained in the Justo Arosemena Hospital. External beam treatment is, therefore,

TABLE I. RADIOTHERAPY INSTALLATIONS AND EQUIPMENT

Institution	Number	Type of external beam therapy equipment	Model
ION (Justo Arosemena Hospital)	1 ^a	^{60}Co unit	Theratron 780C
Ceutio Médico Paitilla	1	Linear accelerator	Varian 18 MeV
CLEONSA	1	^{60}Co unit	Theratron 780C

^a In the Justo Arosemena Hospital, there was also an ATC/9 Picker and a Stabilipan orthovoltage unit (Siemens). Both had been decommissioned and were not in use at the time of the accidental exposure.

given at the Justo Arosemena Hospital, while brachytherapy treatments, patient hospitalization and clinical follow-up of patients take place in the Gorgas Hospital. External beam therapy treatments are given from 06:00 to 21:00 using a Theratron 780C ^{60}Co unit.

The five radiation oncologists rotate between the Gorgas and Justo Arosemena Hospitals. Each month two of them are assigned to the installation on Justo Arosemena Ave., working in two shifts to cover all of the time that the radiotherapy unit is in use. The intention is that a radiation oncologist should always be present while patients are being treated, but in practice there is often no radiation oncologist available during the evening shift.

Treatment planning and dose prescription are done at the installation on Justo Arosemena Ave. The data are entered in a physics chart, which remains at the hospital. The management of the patient's treatment is recorded in a clinical chart, which is kept in the Gorgas Hospital. Patients are seen by the radiation oncologist at the installation on Justo Arosemena Ave. at the beginning of their treatment. They are followed up clinically at the Gorgas Hospital in mid-treatment and at the end of treatment, although usually not by the same radiation oncologist who prescribed the treatment. The Radiotherapy Department does not have written protocols, but the staff follow manuals by Fletcher [4] and Pérez and Brady [5], copies of which are kept at the Justo Arosemena Hospital, and these appeared to be frequently consulted.

2.2.1. External beam radiotherapy

According to the information provided to the IAEA Team, the treatment planning process at the ION is the following. For each patient it starts with a radiation oncologist prescribing an appropriate radiation dose to control the malignant tumour.

TABLE II. BREAKDOWN OF CANCER TREATMENT AT THE ION

Cancers treated	Percentage of treatments
Breast	16.8
Cervix	15.5
Endometrium	1.5
Head and neck	12.1
Prostate	9.3
Brain	4.3
Lung	7.9
Colon and rectum	3.9
Others	28.7

The prescribed radiation dose is delivered to the tumour by irradiating it with a beam of gamma rays from the cobalt radiotherapy unit. The dose is divided into daily fractions given on different days over a period of several weeks. Each fraction may involve several different 'fields', in each of which the radiation beam is pointed at the tumour from a different direction. The prescribed radiation dose is recorded in the patient's clinical chart by the radiation oncologist. This chart also has anthropometric information collected during the simulation process⁵. A source-to-skin distance (SSD) technique⁶ is always employed at the ION, even for multiple field treatments, and the dose prescriptions require all fields to be applied on each treatment day, except for treatments with eight fields. In these cases four fields were used every day. If shielding blocks are to be used to prevent giving too high a radiation dose to normal tissue, the radiation oncologist draws the cross-sectional shapes of the blocks and their positions in the treatment field on the X ray film obtained during the simulation process. A physicist enters the necessary data into the computerized TPS, a 2-D Multidata Radiation Therapy Treatment Planning System, RTP/2 Software Version 2.11 (see Section 2.3 for a full description), which has options for external beam and brachytherapy computations. The information to be entered includes, among other data:

- The total radiation dose prescribed;
- The number of treatment days;
- The SSD;
- Details of each field;
- An outline of the cross-section of each shielding block, drawn on a digitizing tablet;
- The attenuation of the radiation beam by each shielding block.

The TPS calculates treatment times and dose distributions. These are copied by the physicist from the computer printout into the patient's physics chart and they are checked and signed by another physicist.

The patient's clinical and physics charts show that the transfer of data from the oncologist's prescription and the TPS to the patient's physics chart is double checked

⁵ Treatment simulation is an essential step in radiotherapy, in which the treatment geometry is reproduced by using X ray equipment, and the image obtained is used to visually control the tissues and organs that will be later included in the treatment beam.

⁶ SSD is an external beam treatment technique in which a fixed distance between the source and the skin is used.

and signed by the two physicists. However, there are no manual checks of whether the computer calculated treatment times are correct, and the technologists do not participate in the dose calculation process. The ION has protocols for quality control of the radiation therapy equipment, which were found to be complete from 1999 to date, but no quality control procedures regarding checking of the treatment planning calculations.

2.2.2. Brachytherapy

Some cases of cancer of the cervix are treated at the ION, as elsewhere, by radiation, both from an external beam and by brachytherapy, in which small radiation sources are placed inside the patient close to, or inside, the tumour. Brachytherapy has the advantage that high doses can be delivered to a tumour while minimizing damage to surrounding normal tissue because of the rapid fall-off of the dose at a distance from the source. It is supplemented by external beam therapy to deal with parts of the tumour or subclinical disease which do not receive a high enough dose from brachytherapy.

Sources in patients undergoing brachytherapy emit radiation that may expose the hospital staff and other patients. One way to optimize radiation protection is to place the patients in rooms with additional structural shielding. There are four of these rooms in the Gorgas Hospital, and they are shared with patients undergoing nuclear medicine treatments. The consequence of this dual use of the rooms is that brachytherapy treatments cannot be given, as desired, either in mid-treatment or immediately after treatment with external beam therapy. Often brachytherapy is scheduled months afterwards, when insertion of the source into the uterine canal is difficult. To compensate for this, the dose delivered during external beam therapy is higher than that recommended by Pérez and Brady [5], whose techniques the staff of the ION try to follow. (Many of these patients have had a hysterectomy prior to radiation therapy treatment; the scar left during surgery was often shielded with a central block.)

Cancer of the cervix is treated both by external beam and brachytherapy, the latter using Suit-Delclos applicators and ^{137}Cs sources and a manual afterloading technique. Until December 2000, brachytherapy treatment times were based on tabulated data for radium sources, and calculated using milligram-hours of radium (mgh Ra) equivalent values of the caesium sources.

Since January 2001, some of the treatment plans for brachytherapy, including dose distributions, have been calculated using the TPS instead. At the Gorgas Hospital, the applicators, loaded with dummy sources, are inserted manually in a minor surgery room by a radiation oncologist. The positions are checked at the same time with a portable X ray machine in the presence of a medical physicist, who then fills out the appropriate data forms. The insertion geometry must always be approved

by the radiation oncologist. The films are taken by the medical physicist to the Justo Arosemena Hospital and the treatment plans are calculated using the TPS.

2.3. TREATMENT PLANNING SYSTEM

According to the information provided to the IAEA Team, the TPS used at the ION was the RTP/2 Multidata System, Version 2.11 by International Corp., license Americal Megatrends Inc., 40-0103-016155-00011111-111192-SYMP-F. The manual in use has the title 'User & Reference Guide Level II, Release 2.1 & Up'.

Gamma ray beam data (depth doses and beam profiles) for both ^{60}Co units, the Theratron 780C and the now decommissioned Picker ATC C/9, were entered and verified when the system was first installed in 1993. Output (dose rate for a standard field in reference conditions), field factors, wedge and tray factors are entered in the system when measured, which is usually when the ^{60}Co source is replaced. The activities of the ^{137}Cs sources used in brachytherapy were entered in units of mg Ra equivalent until the beginning of 2001.

The TPS has several computing options:

- 'Dose Chart Calculator' is used to calculate the treatment times needed to deliver a given dose to a prescription point, including the use of blocks.
- 'Irreg' is an option to calculate the treatment times needed to deliver a given dose to selected points, specifically for complicated, irregular shaped fields, for example the so-called mantle field.
- 'External Beam' is used when it is intended to generate isodose distributions together with the calculation of the treatment time to deliver a given dose to a prescription point. It was this option that was in use when excessive treatment times were calculated.
- 'Brachytherapy' computes isodose distributions when using brachytherapy sources.

Physicists at the ION used the 'Dose Chart Calculator' option of the TPS to calculate dose to the prescription point, except for irregular shaped fields for which the 'Irreg' option was used. The 'External Beam' option was used only when dose distributions were requested by the radiation oncologist (dose distributions were not requested for all patients).

The physicists compute the required dose distributions following the TPS User & Reference Guide. This manual indicates that it is permitted to enter up to four blocks; however, as described in Section 6.2 of this report, no instructions on how to digitize the block contours are given.

2.4. RADIATION PROTECTION INFRASTRUCTURE AND REGULATORY CONTROL

Radiation protection in the Republic of Panama is regulated by Executive Decree No. 1194 of 3 December 1992. This legal instrument establishes that the Ministry of Health is the Competent Authority for the regulatory control of all activities involving the use of sources of ionizing radiation in the country. It also establishes that the technical unit for regulatory control is the Department of Radiological Health (DSR) of the Social Security Agency. The relationship of the technical unit (DSR) with the Ministry of Health and the Social Security Agency is illustrated in Fig. 1.

The Department of Radiological Health has 13 professionals with university degrees. Three of them belong to the Control Section and are fully dedicated to regulatory control, while the other ten belong to the Services Section (see Fig. 1).

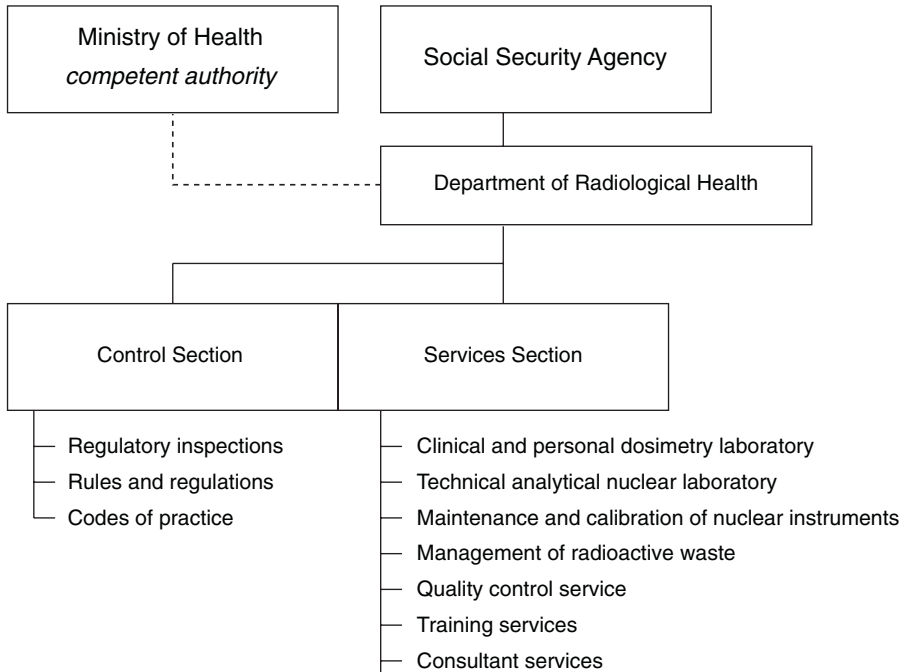

FIG. 1. The regulatory authority.

2.4.1. Authorization of the Radiotherapy Department

The application for authorization of the Radiotherapy Department of the ION was submitted in 1997, but the authorization had not been granted by the time of the accidental exposure, pending the resolution of several issues. Only those most relevant to this report, taken from the records of the regulatory authority (DSR), are listed below:

- A number of reminders sent out by the regulatory authority (DSR), from 1997 to date, indicate that the Radiotherapy Department was not able to provide all the information requested by DSR, principally the manuals of procedures for radiation protection and quality assurance.
- In 1997, an IAEA expert mission discovered that a number of brachytherapy sources were missing from the ION and were found to be in use at the private CLEONSA Clinic, without authorization.
- An incident occurred in which a cobalt therapy radiation source did not return to the 'OFF' (shielded) position, risking excessive radiation exposure of staff and patients, there being no radiation oncologist present at the hospital at the time.
- A nuclear medicine incident with a therapeutic amount of a radiopharmaceutical occurred in a brachytherapy room when, instead of the prescribed amount of 5.6 GBq of ^{131}I , the patient received 11.5 GBq (although the administration of radiopharmaceuticals is usually a nuclear medicine procedure, this incident appears in the records of this facility).
- A letter sent by the regulatory authority reminding the hospital of its obligation to have at least one radiation oncologist always present when patients are being treated.
- In October 2000, the regulatory authority initiated disciplinary sanctions against the ION, because of non-compliance with its reiterated instructions.

2.5. HISTORY OF RECENT AUDITS OF THE RADIOTHERAPY DEPARTMENT

2.5.1. Audit in February 1999

The 1999 IAEA audit involved a review of the quality control activities of the ION, an intercomparison of the dosimetry equipment of the ION and the DSR, a calibration and a quality control check of the treatment units and a test of the TPS.

The auditors noted the following information with regard to the acceptance tests of the Multidata TPS:

- The system was installed in 1993 by a specialist from Multidata, who also entered the basic data (the isodoses for single fields of the ^{60}Co units);
- The medical physicists of the ION compared treatment times obtained from the Multidata TPS for certain typical treatments with those calculated manually for the same treatments;
- Dose distributions (isodoses) for typical treatments were obtained from the Multidata TPS and compared with the isodoses from another TPS in a private clinic in Panama (Theraplan V) for the same typical treatments;
- No records of these tests had been kept.

With regard to the quality control checks of the equipment and accuracy of the doses delivered to patients, the auditors reported:

- Calibrations of the beams for the two ^{60}Co units were regularly performed by the ION. Results were recorded in a logbook, but there was no document specifying the frequency of the measurements.
- Daily checks of the items specified in Ref. [6] were performed by the radiotherapy technologists, reviewed by the medical physicists and recorded. Monthly mechanical checks were performed by the medical physicists but were not recorded.
- An intercomparison was performed by the IAEA during the audit using the available dosimetry equipment from the ION and the DSR. The differences were within $\pm 1.8\%$.
- The auditors carried out quality control tests of all three external beam units, and compared their values with the values in use in the hospital. The differences were acceptable, with the only significant discrepancy of 10% in the timer of the orthovoltage unit.
- The auditors also tested the TPS for different conditions: open field, wedged field and a field with two shielding blocks. The tests consisted of:
 - (1) Manual checks of the treatment time for some randomly selected patient charts, including box technique treatments, irregular fields and wedges. The TPS results were within a 1% difference between the treatment times from the patients' charts and the ones calculated by the auditors based on the data and factors in use.
 - (2) Prescribing a dose to a point in a water phantom, calculating the irradiation time with the TPS, irradiating the water phantom using the irradiation time calculated by the TPS and measuring the actual dose delivered to the prescription point in the water phantom. The difference between the prescribed dose and the measured dose was within $\pm 1.8\%$ for the Theratron 780C unit.

- (3) For brachytherapy, the auditors compared doses calculated by the TPS to a selected point with values obtained from tables. The differences were within $\pm 3\%$.

The auditors recommended that the ION should establish a quality assurance programme based on IAEA-TECDOC-1151 [6].

2.5.2. Audit in February 2001

By the time of this audit, both the Picker ATC C/9 ^{60}Co unit and the Stabilipan orthovoltage unit had been decommissioned. This audit noted that quality control checks of the Theratron 780C ^{60}Co unit were being regularly carried out. They included daily, monthly and annual checks, following IAEA-TECDOC-1151 [6], and the results were well documented.

Other statements in the audit report that are relevant to this report are as follows:

- An intercomparison was performed of the available dosimetry equipment from the three radiotherapy departments in Panama (ION and two private hospitals). The differences were within $\pm 1.2\%$.
- The auditors verified the values of the parameters included in the protocols of IAEA-TECDOC-1151 [6]. The differences between the ION and auditors' measurements were: within $\pm 0.4\%$ for the dose rate in reference conditions (5 cm depth in water at 80 cm SSD); within 0.3% for field size factors; within $\pm 1\%$ for the tray factor; within $\pm 4.9\%$ for the wedge factors. The auditors found that the transit time of the source (-0.016 min) was not being corrected for by the medical physicists. This implies an error in dose of 1.6% for an irradiation time of 1 min.
- The auditors also tested the TPS for different conditions: open field of different field sizes, wedged field, and a field with one shielding block. The testing consisted of prescribing a dose to a point in a water phantom, calculating the irradiation time with the TPS, irradiating the water phantom using the irradiation time calculated by the TPS and measuring the actual dose delivered to the prescription point. The difference between the prescribed dose and the measured dose was within $\pm 2.1\%$.
- Localization in gynaecological brachytherapy was done by orthogonal X ray films. Conventional X ray equipment was used for simulation/localization for external beams.
- New ^{137}Cs sources had been acquired since the previous audit, and there was a complete inventory of all sources. All source certificates were available and all these sources were regularly checked by the medical physicists. Spot checks of

the source calibrations were performed during the audit and the differences between the values obtained and the values in use at the ION were within $\pm 2.6\%$, in terms of the dose rate at one metre.

It is important to note that the auditors were not made aware that the method of entering data for several blocks had been changed. Since there were no written procedures, the auditors did not realize that this change had been made, and no tests were done following the new procedure for digitizing several blocks together as if they were a single block.

2.5.3. Results of IAEA/WHO TLD postal dose quality audits performed at the ION

The ION has participated in the IAEA/WHO TLD postal programme for radiotherapy hospitals on a regular basis since 1987. The check of calibration of the two ^{60}Co machines was performed during these years according to the procedure developed by the IAEA [7]. The TLDs were sent to the ION along with instructions to irradiate them in the same way as a patient is irradiated in normal clinical practice. To reflect the clinical situation, the calculation of irradiation time to deliver the dose of 2 Gy was requested to be performed in the same way as for patient treatments. When the irradiated TLDs arrived at the IAEA, they were analysed and the doses were computed for each dosimeter. The acceptance limit of the IAEA/WHO TLD audits for hospitals is $\pm 5\%$ and this defines the maximum discrepancy between stated and measured doses which does not require any further investigation. When the result of a hospital falls outside the acceptance limit of $\pm 5\%$, follow-up actions are performed.

The results of the IAEA/WHO TLD postal dose quality audit for the ION (16 checks), including the last audit performed at the ION in August 2000, show that the mean ratio of the dose measured by the IAEA to the dose stated by the institute is 1.016 ± 0.025 ; only once (in 1995) was the deviation outside the acceptance limit of $\pm 5\%$.

3. THE ACCIDENTAL EXPOSURE

3.1. INITIATING EVENT

Treatments in the pelvic region (prostate, cervix, colon) were performed at the ION using four fields, an anterior–posterior pair and two opposed laterals (the box

technique). Sometimes the lateral fields had 30° wedge filters. Most fields included shielding blocks to protect normal tissue. Up to four blocks per treatment field were often used for the pelvic region. All four fields were treated every day during the treatment period. For some patients, four additional oblique fields were employed. In this case, the two treatments (of each set of four fields) were given on alternate days. The treatments were performed using the SSD technique. Following this regimen, patients received booster doses consisting usually of a so-called skip (arc) exposure delivered to a smaller volume of tissue.

For some of the treatments of the cervix, the ION used a central shielding block in addition to the four described above, for example to provide additional protection of critical structures previously involved in surgery (Fig. 2). These cases were calculated without isodose distributions, that is, only the dose to a point was calculated. There was therefore no need to use the 'External Beam' option of the TPS, and the 'Dose Chart Calculator' option was used instead. This option allowed more than four shielding blocks to be digitized.

According to the information provided to the IAEA Team, at some point in time (the date is not exactly known, but it was several months before the event reported here) one of the oncologists requested that dose distributions be calculated for fields with five blocks. This required that the 'External Beam' option of the TPS should be used. Since the TPS only allowed the entry of data for four blocks per field under this option, the physicists obtained isodoses by digitizing less than five blocks per field, usually four blocks, while all five blocks were actually used during patient treatment.



FIG. 2. Example of a field drawn with five blocks (reproduced from the patient's chart). The arrows indicate the locations of the blocks.

Data for one of the blocks were not entered and therefore not considered in the calculation.

Digitizing only four of the five blocks causes an error in calculating the dose to the prescription point because the computer takes into account the scatter component of the radiation coming from all irradiated parts of the patient. In this case the irradiated parts assumed by the computer include those parts that in fact would be covered by the fifth shielding block, which was not entered into the computer. The actual contribution to scatter radiation coming from the shielded region is, therefore, lower than the one assumed by the computer calculation. If treatment is given for the duration calculated by the computer, the patient will receive a dose of the order of a few per cent less than that prescribed. This effect was understood and accepted as part of the temporary solution. The team was informed that the physicists omitted the data for the smallest block from the TPS so as to further minimize the error.

Although this approach was relatively safe in that the doses delivered were close to those prescribed, it was felt that it was technically unsatisfactory. Due to the lack of another solution, the approach was used for some time, until August 2000. Then a method was devised for entering data for more than four blocks. Instead of digitizing the blocks individually, i.e. one block at a time, and completing its data entry before entering the next block (as shown in Fig. 3), the staff members endeavoured to enter the contours in the manner illustrated in Fig. 4. (This figure shows two examples, one with four blocks and one with five blocks because this new quicker method of data entry was used even if no fifth block was required.) In this method of entry, the physicist digitized the blocks by following a loop with the inner boundaries of the blocks (in one direction, for example clockwise), then following the outer boundaries in the same direction, also clockwise. As explained in Section 6 (which describes the experimental tests performed by the team), the computer

Menu:

Add 1 block

Type transmission factor

Digitize contour

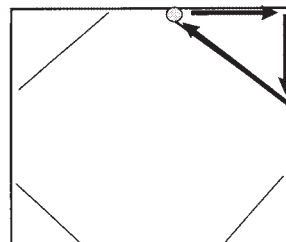

Repeat the procedure with
other blocks

FIG. 3. Data entry of one block at a time.

accepted the data entered in this way but the calculated treatment times were later found to be substantially larger than they should have been.

From August 2000 onwards, data for multiple blocks were entered for a number of cases using the new method when calculating exposures of the pelvic region, even

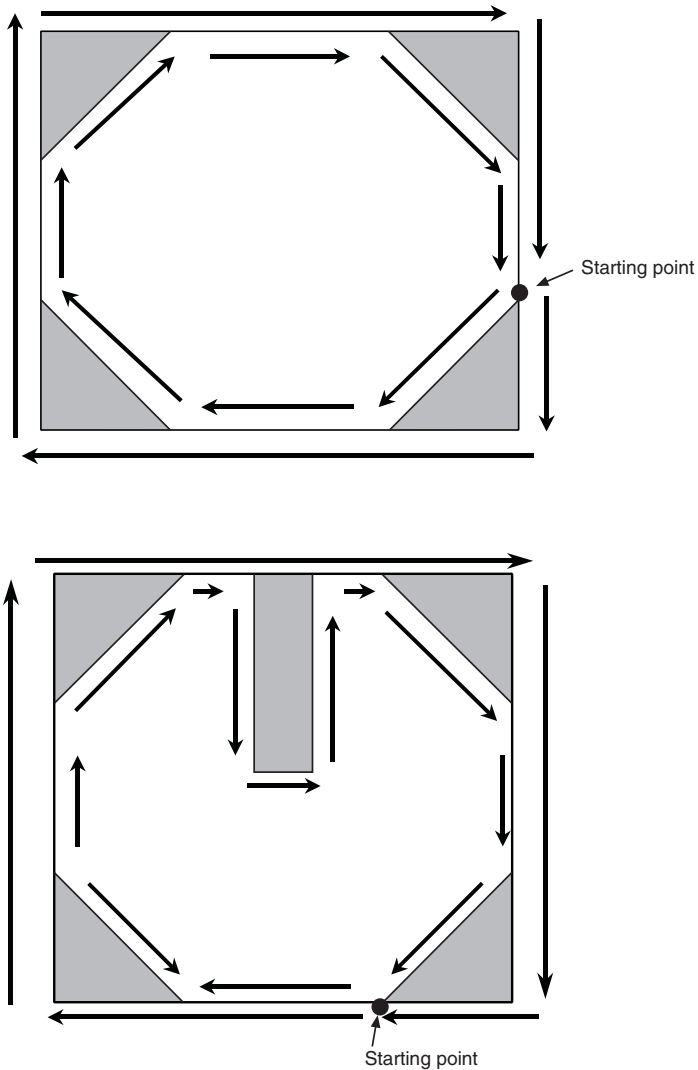

FIG. 4. Circumventing the limitation of the number of blocks by entering the co-ordinates of multiple blocks as a single block with two loops in the same direction. The shaded areas denote the blocks. The computer accepts this way of digitizing multiple blocks describing two loops in the same direction, but calculates the wrong treatment time by about +100% (referred to as 5% block transmission).

when a fifth shielding block was not required. Treatments of other regions of the body which required blocks were still calculated by digitizing each block separately.

Since the procedure was not put in writing, the shortcut was apparently used in a slightly different way for some patients. In these cases, the blocks were digitized by following the inner boundaries of the blocks in one direction, and the outer boundaries in the opposite direction. (Fig. 5). It was later found that this method of data entry did not lead to an incorrect treatment time (see Section 6). The treatment times calculated with this method later turned out to be essentially correct .

3.2. DISCOVERY OF THE PROBLEM

The information received from various sources about the chronology of this accidental exposure is slightly different. The dates indicated below were taken from an official report of the regulatory authority (DSR) [8].

In November 2000, the radiation oncologists started to observe diarrhoea in some patients which was unusually prolonged. They asked the physicists to review the treatment plans for patients with these symptoms. The physicists reviewed the charts but did not discover any anomaly. It should be noted that double-checking of patient charts was common practice in this institute, but, as indicated in Section 2.2.1, the computer outputs (the dose distributions and the treatment times) were not

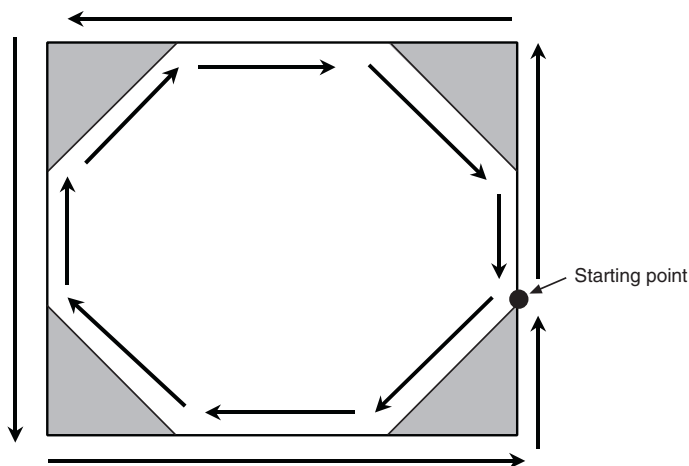

FIG. 5. Entering co-ordinates of multiple blocks as a single block, but with loops in the opposite direction. The computer calculates the correct treatment time when the two loops are in the opposite direction.

included in these checks, the implicit assumption being that the computer calculations were correct.

In December 2000, similar abnormal symptoms were observed in other patients. In February 2001, the physicists initiated a search for the possible cause of these effects, but it was only in March 2001 that the physicists identified that there was a problem with the calculation of treatment times and informed the radiation oncologist on duty. The treatment of patients presenting abnormal symptoms was suspended. Patients treated with the modified method of data entry were identified and their patient charts were reviewed.

It then became apparent that the patients who had their treatment times calculated using the 'shortcut' method of data entry had received doses larger than prescribed, and in mid-March the Director General of the ION was informed. Measurements were then performed using a water phantom simulating the conditions under which a patient was treated, and the error was confirmed.

It was also discovered at this time that the sequence in which the co-ordinates of the blocks were digitized affected the calculated treatment times and hence the doses delivered. Patients for whom the co-ordinates had been digitized in the sequence shown in Fig. 4 had isodoses and treatment times calculated that were similar to the correct ones (the ones from blocks entered individually).

4. RESPONSE TO THE ACCIDENTAL EXPOSURE

4.1. ACTIONS TAKEN UPON DISCOVERY OF THE ERROR

24 March 2001

The Panamanian Ministry of Health contacted the representative of PAHO in Panama with a request for assistance in verifying patient doses. This representative passed on the request to the PAHO Regional Office. The Ministry of Health supplied PAHO with an example of the treatment calculations and physics data, provided by the ION [9], for one of the affected patients. PAHO estimated the absorbed dose to the patient received by this patient to be about 94 Gy, and informed the Ministry of Health through its representative in Panama.

April 2001

The affected patients were identified and the absorbed doses and dose distributions were recalculated, using the procedure of introducing the blocks separately into the RTP/2 treatment planning computer from Multidata, by the physicists at the ION.

Independently, PAHO performed the calculation of patient doses manually and confirmed the exposure to its representative in Panama and provided a copy of its report to the Director General of the ION on 16 April 2001 [10, 11].

On 19 April 2001, the group of consultants appointed at the request of the ION arrived. The group was composed of one radiation oncologist and two medical physicists from the MD Anderson Hospital. The group replicated the error and tried to determine the possible problem with the algorithm. It concluded that, “although no full explanation could be found it was suspected that the algorithm fails to account for the scatter component when the data is entered in a certain way”.

The report further states that “Upon return to Houston, calculations for two cases were repeated using a different treatment planning system. The results confirmed the findings found during the visit.” The report also states that “Multidata Systems International Corp. was contacted and the problem was reported to them. Arrangements were made to have Multidata contact ION directly and it was impressed upon Multidata to send someone to Panama as soon as possible to resolve this problem.”

14 May 2001

The General Subdirector of the ION informed the regulatory authority DSR about the accidental exposure.

16 May 2001

The ION provided the DSR with documents related to the accidental exposure.

17 May 2001

The DSR provided a copy of the report to the General Director of Health, with the recommendation that medical assistance in treating the overexposed patients be sought.

21 May 2001

The DSR began a technical evaluation of the accidental exposure for the Minister of Health.

25 May 2001

The DSR issued its report [8].

4.2. RESPONSE FROM THE IAEA

On Saturday 19 May 2001, the IAEA Duty Emergency Response Manager (ERM) was informed of the accidental exposures in Panama by an IAEA staff

member in the Department of Technical Co-operation. This staff member conveyed to him information about the incident provided by the Panamanian counterpart⁷ to the technical co-operation project ‘Development of Technical Capabilities for Sustainable Radiation and Waste Infrastructure’ — RLA/9/044. The counterpart indicated that the IAEA would be receiving a request for assistance in a few days.

On Monday 21 May 2001, the IAEA Duty ERM contacted the National Competent Authority in Panama by telephone to obtain more detailed information about the incident. The Panamanian Competent Authority confirmed the accuracy of the information provided by the counterpart and confirmed that Panama would be requesting the IAEA to provide assistance under the terms of the Convention on Assistance in the Case of a Nuclear Accident or Radiological Emergency.

On the same day, a message was received from the competent authority requesting the IAEA to provide a technical expert team to evaluate the incident. The IAEA’s Emergency Response Centre (ERC) then contacted the appropriate experts to inquire about their willingness and availability to take part in this IAEA mission.

On Tuesday 22 May 2001, the Permanent Mission of Panama to the IAEA sent a facsimile message addressed to the IAEA’s Director General requesting assistance to Panama in connection with the emergency situation.

The IAEA ERC sent out an advisory information message to all National Warning Points (NWP), all National Competent Authorities and all Permanent Missions to the IAEA. This informed them of the emergency situation in Panama and informed them that the Agency was sending an expert team there. A number of countries then requested more information and some offered medical assistance.

The terms of reference of the IAEA’s mission to Panama were established and approved by the Panamanian authorities. The terms of reference required the mission to, *inter alia*:

- Ensure that the radiation source(s) involved in the accident was (were) in a safe and secure condition;

⁷ Coincidentally, the Panamanian counterpart is also the National Competent Authority for the Convention on Early Notification of a Nuclear Accident (Early Notification Convention) and the Convention on Assistance in the Case of a Nuclear Accident or Radiological Emergency (Assistance Convention).

- Evaluate the doses incurred by the affected patients, inter alia by analysing the treatment records and physical measurements;
- Undertake a medical evaluation of the affected patients' prognosis and treatment, taking into account, inter alia, the autopsy findings for those who died; and
- Identify issues on which the IAEA could offer to provide and/or co-ordinate assistance to minimize the consequences of the accident.

The team was established and arrived in Panama on Saturday 26 May 2001. The team was composed of experts in radiopathology, radiotherapy, radiology, radiation protection, and medical physics from France, Japan, the USA and the IAEA. Two days later, the team was joined by an expert from the Russian Federation representing the World Health Organization (WHO) and by M. Akashi from Japan. The members of the international team were:

- M. Akashi, Research Center for Radiation Emergency Medicine of the National Institute of Radiological Sciences, Chiba, Japan;
- J.M. Cosset, Département de Radiothérapie, Service B, Institut Curie, Paris, France;
- P. Gourmelon, Centre d'Etudes Nucléaires, Institut de Protection et de Sûreté Nucléaire, Fontenay-aux-Roses, France;
- M. Konchalovsky (representing WHO), Hematologic Department of the Scientific Research Center of Russia, Moscow, Russian Federation;
- F. Mettler, Chairman, Department of Radiology, University of New Mexico, School of Medicine, Albuquerque, USA;
- P. Ortiz López, IAEA;
- S. Vatnitsky, IAEA.

At the request of the Government of Panama, expressed during the mission, a staff member of PAHO, C. Borrás, joined the international team.

The mission was concluded on Friday 1 June 2001.

On Saturday 2 June 2001, another advisory information was sent from the IAEA's ERC to all National Warning Points, National Competent Authorities and Permanent Missions reporting the preliminary findings of the expert team. On Saturday 9 June 2001, a termination report was sent out to the same contact points confirming the findings of the preliminary report and notifying them that the ERC had terminated its activation level in response to the emergency situation. The aim of these communications was to provide enough information and advice to States to help to avoid a similar accidental exposure elsewhere in the coming months, pending the publication of a final report. The termination report is included in Annex I.

5. DOSE ASSESSMENT

5.1. INTRODUCTION

The purpose of dose assessment was to obtain an evaluation of the doses received by the patients that were affected by the use of incorrect treatment times. The assessment of external beam doses to patients was carried out by manual calculation. Manual calculations are normally done in radiotherapy departments when a computerized TPS is not used, or to verify computer calculated values. The calculation of patient doses was based on the dose rate, the treatment time and all relevant parameters taken from the patients' charts, as indicated below. Since the calculation of patient doses requires the use of a number of dosimetric factors, all these factors needed to be evaluated and verified by the team.

Standardized quality audit procedures for dosimetry on-site visits to radiotherapy hospitals, developed by the IAEA [12], were used as a guide when performing the dosimetry evaluation. The standard procedures are limited to those carried out under the IAEA/WHO TLD postal dose quality audit programme, and focus on the calibration of radiotherapy machines. For the purposes of this assessment, they were modified to cover the evaluation of the treatment planning process and to investigate the accidental exposure related to the use of the TPS.

In addition to this assessment, an evaluation of the biologically effective dose and the equivalent dose for 2 Gy per fraction was carried out. This was necessary to take account of the fact that in this accidental exposure doses were given in larger fractions than the typical 2 Gy per fraction.

For this assessment, dosimetry measurements were carried out using equipment which was brought by the IAEA members of the team. A standard instrumentation kit was used, which contained the following main items of equipment:

- Electrometer PTW UNIDOS, Serial No. 20334;
- Ionization chambers PTW W30010 Serial Nos 52 and 53, along with calibration certificates from the IAEA Dosimetry Laboratory;
- Barometer AIR-HB-1A;
- Two calibrated mercury thermometers;
- Box water phantom (PTW T41014);
- Two TLD sets and a TLD holder, along with the instruction and data sheets.

5.2. SCOPE OF THE DOSIMETRIC EVALUATION

The dosimetric evaluation performed by the team at the ION focused on the following areas:

- Comparison of IAEA and ION dosimetry systems and ^{60}Co beam calibration.
- Verification of the delivery of prescribed doses to a selected point in the water phantom for different beam arrangements. The verification was carried out by asking ION physicists to calculate exposure times manually and by computer and using the calculated exposure times to irradiate a water phantom, and measuring the corresponding doses to the prescription point in the water phantom using an ionization chamber.
- Assessment of the doses received by the 28 patients with potential overexposure.

The ION dosimetry equipment consists of:

- Electrometer PTW UNIDOS Serial No. 20226;
- Electrometer Keithley E 35614, Serial No. 18097 (calibration certificate from ADCL MD Anderson of 24 October 1984);
- Ionization chamber PTW W30001, Serial No. 1496 (calibration certificate from PTW of 11 September 1997);
- Well type chamber HDR 1000, Serial No. A970931;
- Barometer AIR-HB-1A;
- Thermometer Digital Fluke 52.

The comparison of the IAEA and ION dosimetry systems and the verification of the delivery of prescribed doses were performed by the team at the ION in two sessions on different days. In one session the ION physicists were interviewed on the dosimetry data and treatment techniques used at the ION. The team then reviewed the patient treatment charts in order to evaluate the radiotherapy techniques used at the ION and to ensure that the necessary dosimetry data were available. They also needed to ensure that test dose calculations performed with the TPS corresponded to typical treatments actually performed at the ION. Attention was paid to the data used in dose calculations for pelvic fields.

Safety and mechanical checks of the Theratron 780C treatment unit were carried out following the interview. The requirements of the BSS were considered, as well as those of IAEA-TECDOC-1040 [13] for safety, mechanical and other QA aspects. The results were as follows:

- Door interlocks, radiation warning lights and emergency switches were operational.
- The agreement of the mechanical indicator of gantry rotation with the digital display was within 1°.
- The agreement of the digital indicator of field size with the measured field size was within 2 mm for 5 cm × 5 cm, 10 cm × 10 cm, 15 cm × 15 cm and 20 cm × 20 cm fields.
- The distance from the bottom of the accessory holder to the isocentre was 32 cm.
- The tip of the distance stick was in agreement with the lasers within 1 mm for gantry positions of 90° and 270°.
- The lateral lasers were aligned within 1 mm at ±20 cm distance from the isocentre.
- The timer agreed with a manual stopwatch within 1 s for irradiation times of 1–5 min.

Following safety and mechanical checks, the ION physicists were asked to perform calibration of the ⁶⁰Co beam in the same way as they do during their regular quality control checks, and to irradiate TLDs following the standard procedure recommended by the IAEA for the TLD postal dose audit. The team performed the beam calibration using the IAEA equipment they had brought with them, and the results were compared with the results of the ION calibration.

The team evaluated the ION's method of calculating the irradiation times for patient treatments. The ION physicists were requested to determine time settings for the clinical dosimetry tests, including a rectangular field, a wedged field and a blocked field, as described below. The clinical tests were performed in a water phantom (PTW T41014) using a single field. Time settings were calculated to deliver 2 Gy to the prescription point located on the beam at a depth of 5 cm. The following set-ups were entered into the TPS:

- Field size 6 cm × 16 cm. Prescription point on the central axis.
- Field size 8 cm × 8 cm, with 30° wedge. Prescription point on the central axis.
- Field size 15 cm × 15 cm, with shielding blocks. Prescription point 3.5 cm off-axis.

The calculated time settings were verified by manual calculation and were used on the Theratron 780C treatment unit. The team verified that the prescribed doses were delivered to the specified points in the phantom using ionization chamber measurements.

During the second session a direct intercomparison of ION and IAEA dosimetry systems was performed. The aim of this intercomparison was to verify the

constancy of response of the ION dosimetry system, with reference to the calibration certificate.

5.3. COMPARISON OF THE DOSIMETRY SYSTEMS AND BEAM CALIBRATION

5.3.1. Dosimetry system intercomparison

As a part of the evaluation of the ION dosimetry system, an intercomparison of barometers and thermometers was performed. The results are listed in Table III.

A comparison of the ION's dosimetry system with the IAEA dosimetry system was performed by sequential irradiation of ionization chambers in reference conditions in the ^{60}Co beam of the Theratron 780C treatment unit using the PTWT41014 water phantom. The depth of measurement was 5.0 g/cm^2 , field size $10 \text{ cm} \times 10 \text{ cm}$, $\text{SSD} = 80 \text{ cm}$. The IAEA chambers, PTW W30010, Serial Nos 52 and 53, were calibrated in terms of air kerma and absorbed dose to water at the IAEA Dosimetry Laboratory and their calibration factors are traceable to the Bureau International des Poids et Mesures (BIPM). The calibration factor of the ION ionization chamber⁸ was derived from this comparison and was compared with the value listed in the certificate issued on 27 April 1997 by PTW Freiburg: $N_k = 47.59 \text{ mGy/C}$. The reference temperature and pressure are 20°C and 101.3 kPa . The results are listed in Table IV.

TABLE III. BAROMETER AND THERMOMETER INTERCOMPARISON

	IAEA	ION	k_{TP} ratio IAEA/ION
Pressure (kPa)	101.15	101.13	
Temperature ($^\circ\text{C}$)	26.0	26.4	
k_{TP}	1.022	1.024	0.998

TABLE IV. COMPARISON OF CHAMBER FACTORS

Factor of IAEA chamber N_k (mGy/C)	Factor of ION chamber N_k (mGy/C), derived	Certificate/derived
49.0 (PTW W30010 No. 52)	47.73 (PTW W30001 No. 1496)	1.003
49.4 (PTW W30010 No. 53)	47.58 (PTW W30001 No. 1496)	1.000

⁸ The chamber was calibrated in air in terms of air kerma (factor N_k).

5.3.2. ^{60}Co beam calibration

For the calibration of the ^{60}Co beam, i.e. the determination of the absorbed dose rate to water in reference conditions, the IAEA Code of Practice for absorbed dose determination for high energy photon beams [14] was used.

The results on 29 May 2001 are listed in Table V. The team determined the shutter correction (correction for the transit time of the source) and the value obtained was -0.018 min, while the value obtained by the ION was -0.016 min.

The analysis of the TLDs irradiated by the ION physicists during the mission was performed on arrival in Vienna by the IAEA members of the team. The result of this check showed that the difference between stated and measured doses is within the acceptance limit of the IAEA/WHO TLD dose quality audits for hospitals.

5.3.3. Variation of absorbed dose with field size

The variation of the dose rate with field size at a depth of maximal dose ($d_{\text{max}} = 0.5$ cm) at SSD 80 cm in a full scatter phantom (relative output factors) was derived from the measurements at 5 cm depth using standard depth dose data from Ref. [15]. The results are listed in Table VI and were used by the team as the reference data set.

TABLE V. COMPARISON OF ^{60}Co BEAM CALIBRATION

Field Size (cm \times cm)	IAEA (Gy/min)	ION (Gy/min)	IAEA/ION
10 \times 10	1.666	1.633	1.02

TABLE VI. COMPARISON OF OUTPUT FACTORS

Field size (cm \times cm)	IAEA output factor	ION output factor	IAEA/ION
5 \times 5	0.950	0.948	1.002
10 \times 10	1.000	1.000	1.000
15 \times 15	1.047	1.055	0.992
20 \times 20	1.072	1.069	1.003

5.3.4. Depth dose data

The ION uses published central axis depth dose data from BJR-25 [15] in the calculation of absorbed dose for the ^{60}Co unit. No measurement of the percentage depth dose (PDD) was done by the team as standard depth dose data were entered into the TPS.

5.3.5. Wedge transmission

The wedge transmission factor is defined as the ratio of doses with and without the wedge at a point in the phantom along the central axis of the beam. The wedge transmission factors at the ION were determined for a 10 cm \times 10 cm field at 5 cm depth in water, at an SSD of 80 cm. A spot check of the factor for a 30° wedge was performed, as this wedge is frequently used in pelvic fields. The results are listed in Table VII.

5.3.6. Verification of dose delivery

The verification of dose delivery was performed by prescribing a dose (2 Gy) to a selected point in a water phantom treated with a single field. Three tests were performed for various irradiation conditions: a rectangular field, a wedged field and a field with blocks. The ION physicists were asked to calculate, using the TPS, the irradiation times that are needed to deliver the prescribed dose. Then, the phantom was irradiated in a ^{60}Co beam using the calculated treatment time and the actual dose was measured with an ionization chamber. The results of the measurements were compared with the prescribed dose and are listed in Table VIII.

TABLE VII. COMPARISON OF WEDGE TRANSMISSION FACTORS

Description	IAEA	ION	Ratio IAEA/ION
30° wedge, 10 cm \times 10 cm	0.716	0.720	0.994

TABLE VIII. RESULTS OF BEAM TESTS IN CLINICAL CONDITIONS

Field size (cm \times cm)	TPS prescribed dose (Gy)	IAEA measured dose (Gy)	Ratio measured/prescribed
6 \times 16	2.00	2.06	1.03
8 \times 8 (with 30° wedge)	2.00	2.05	1.03
15 \times 15 (with blocks)	2.00	2.01	1.01

5.4. PATIENT DOSES

5.4.1. Assessment of doses from irradiation with external beams

Before evaluating the doses to patients, the team verified and reproduced the incorrect calculation of treatment times when several shielding blocks are digitized as a single block, describing two loops in the same direction. Manual calculation of actual doses delivered to each individual patient was done using treatment times indicated in the patient charts, since these are the times that were used for the patient irradiation.

The doses were calculated for the point of intersection of beam axes for multiple fields (the prescription point). The calculations employed the following parameters and information:

- Treatment time (from patient charts);
- Absorbed dose rate to water at the reference conditions (based on IAEA measured values, 29 May 2001);
- Field size, equivalent field size (from patient charts);
- Depth (from printout of treatment plans);
- Output factors (from clinical dosimetry data);
- Wedge factors (from clinical dosimetry data);
- Depth dose data (from BJR-25 [15]).

A table of calculated doses at the prescription point for the 28 affected patients⁹ was provided to the medical team of the mission for comparison with the clinical findings. This information was complemented with the TPS calculated dose distributions (printouts of treatment plans) produced by the ION physicists for each of the 28 patients, using the procedure to digitize the co-ordinates of the shielding blocks in the TPS separately. These treatment plans were compared with the treatment plans affected by the error when the data for several blocks were entered into the TPS as if they were a single block, describing two loops in the same direction.

⁹ The report by the DSR [8] indicates that an additional patient might have been affected by a dose that was 43% higher than intended. The team checked that, according to this patient's chart, the patient was treated with the incorrect time for only one fraction, and the rest of the treatment was delivered with the time corrected. This patient was treated in March 2001, about the time when the error was discovered.

The results are given in Table IX, where doses to the prescription point are listed. The dose to critical structures, such as bowel and rectum, are slightly different as can be inferred from the dose distributions. More accurate calculations of doses to these structures were not performed because of the lack of anatomical information for each particular patient.

The following abbreviations are used in the table:

- Field dir: antero/posterior (AP), postero/anterior (PA), left lateral (LLT), right lateral (RLT) and oblique;
- Equivalent square (BF) = equivalent square for blocked field;
- OF = output factor for open field;
- d_{\max} = absorbed dose rate to water at a depth of dose maximum (0.5 cm);
- Depth dose = the quotient of the absorbed dose at any depth to the absorbed dose at a depth of d_{\max} ;
- N = number of fractions;
- Equiv. $D(2)$ = the dose that would need to be given if the treatment were in fractions of 2 Gy each to achieve the same biological effect.

5.4.2. Consideration of brachytherapy treatments

Cancer of the cervix was treated by combining external beams therapy with brachytherapy for 11 of the patients affected by this event. As mentioned in Section 2, brachytherapy doses are prescribed and recorded in milligram hours radium (mgh Ra) equivalent. The doses to the uterus can be converted to absorbed dose in gray to the uterus. However, since anatomical information was available for only 2 of the 11 patients, the doses to the rectum (1 cm away from the ovoids) are very uncertain because of the steep dose gradient in brachytherapy treatments. The doses to the rectum and bladder might be of the order of 15–30 Gy, in addition to the doses delivered by external beam therapy.

5.4.3. Doses equivalent to treatments of 2 Gy per fraction

Since the event resulted in fractions with high doses (up to 4 or even 6 Gy per fraction), there was a need to compare the total doses with those of normal therapy, i.e. therapy given in fractions of about 2 Gy each, in order to evaluate the clinical effects. For this purpose, the 2 Gy per fraction equivalent dose has been calculated and included in the table.

It should be noted that the equivalent to the 2 Gy per fraction dose was calculated using an α/β ratio 3 for the intestine. This ratio is appropriate for late effects. The resulting Equiv. $D(2)$ values in Table IX should not, therefore, be used for the evaluation of early effects.

TABLE IX. CALCULATION OF DOSES TO PATIENTS FROM EXTERNAL BEAM TREATMENTS

Patient number	Field dir.	Field size	Equiv. square (BF)	FSF (OF)	Depth (cm)	Depth dose (BF)	Time (min)	Date	Dose rate at d_{\max} (Gy/min)	Wedge factor	Tray factor	Dose/fraction	N	Total dose/field (Gy)	Total dose (Gy)	Equiv. $D(2)$ (Gy)	
1	AP	16	14.5	1.06	10	0.59	1.51	Dec-00	1.77		0.982	1.64	8	13.10			
	PA	16	14.5	1.06	12.5	0.50	1.82	Dec-00	1.77		0.982	1.67	8	13.39			
	RLT	10.5	10	1.01	20	0.27	1.31	Dec-00	1.77		0.982	0.63	8	5.01			
	LLT	10.5	10	1.01	18	0.32	1.4	Dec-00	1.77		0.982	0.77	8	6.19			
														4.71		37.69	58.14
	AP	16	14.5	1.06	10	0.59	1.25	Feb-01	1.73		0.982	1.33	7	9.28			
	PA	16	14.5	1.06	12.5	0.50	1.25	Feb-01	1.73		0.982	1.12	7	7.87			
	RLT	10.5	10	1.01	20	0.27	1.37	Feb-01	1.73		0.982	0.64	7	4.48			
	LLT	10.5	10	1.01	18	0.32	1.25	Feb-01	1.73		0.982	0.68	7	4.73			
														3.77		26.37	35.68
									Dec-00							11.00	11.00
									Jan-01							10.00	10.00
	Open oblique															26.00	26.00
	Open oblique																
	ARC																
																111.06	140.82
2	AP	16	15	1.06	11.5	0.53	1.51	Dec-00	1.77		0.982	1.46	15	21.86			
	PA	16	15	1.06	12.5	0.50	1.51	Dec-00	1.77		0.982	1.39	15	20.82			
	RLT	10.5	9.5	1.01	19	0.29	1.53	Dec-00	1.77		0.982	0.77	15	11.61			
	LLT	10.5	9.5	1.01	19	0.29	1.53	Dec-00	1.77		0.982	0.77	15	11.61			
														4.39		65.91	97.47
	AP	16	15	1.06	11	0.55	1.45	Jan-00	1.75		0.982	1.45	5	7.25			
	PA	16	15	1.06	11	0.55	1.4	Jan-00	1.75		0.982	1.40	5	7.00			

TABLE IX. (cont.)

Patient number	Field dir.	Field size	Equiv. square (BF)	FSF (OF)	Depth (cm)	Depth dose (BF)	Time (min)	Date	Dose rate at d_{\max} (Gy/min)	Wedge factor	Tray factor	Dose/fraction	N	Total dose/field (Gy)	Total dose (Gy)	Equiv. $D(2)$ (Gy)	
	RLT	10.5	9.5	1.01	17	0.34	1.47	Jan-00	1.75		0.982	0.86	5	4.31			
	LLT	10.5	9.5	1.01	17	0.34	1.46	Jan-00	1.75		0.982	0.86	5	4.28			
	ARC													4.57	22.84	34.57	
	ARC														30.00	30.00	30.00
	ARC														118.75	162.04	
3	AP	16	14	1.06	11.5	0.53	1.56	Dec-00	1.77		0.982	1.52	20	30.40			
	PA	16	14	1.06	11.5	0.53	1.63	Dec-00	1.77		0.982	1.59	20	31.77			
	RLT	10.5	10	1.01	18.5	0.31	1.62	Dec-00	1.77		0.982	0.86	20	17.24			
	LLT	10.5	10	1.01	18.5	0.31	1.62	Dec-00	1.77		0.982	0.86	20	17.24			
	ARC													4.83	96.66	151.42	
	ARC														20.00	20.00	20.00
	ARC														116.66	171.42	
4	AP	17	16	1.07	11.5	0.53	0.98	Jan-01	1.75		0.982	0.95	28	26.61			
	PA	17	16	1.07	9	0.63	1.25	Jan-01	1.75		0.982	1.44	28	40.35			
	RLT	13	9	1.03	14	0.42	0.88	Jan-01	1.75		0.982	0.65	28	18.12			
	LLT	13	9	1.03	17	0.33	0.91	Jan-01	1.75		0.982	0.54	28	15.00			
	ARC													3.57	100.08	131.60	
5	AP	15	13	1.05	11	0.54	1.19	Feb-01	1.73		0.982	1.15	25	28.64			
	PA	15	13	1.05	10	0.58	1.31	Feb-01	1.73		0.982	1.35	25	33.86			
	RLT	11.5	10	1.02	18	0.32	1.23	Feb-01	1.73		0.982	0.67	25	16.80			
	LLT	11.5	10	1.02	19.5	0.28	1.24	Feb-01	1.73		0.982	0.60	25	14.96			
	ARC													3.77	94.26	127.64	

TABLE IX. (cont.)

Patient number	Field dir.	Field size	Equiv. square (BF)	FSF (OF)	Depth (cm)	Depth dose (BF)	Time (min)	Date	Dose rate at d_{\max} (Gy/min)	Wedge factor	Tray factor	Dose/fraction	N	Total dose/field (Gy)	Total dose (Gy)	Equiv. $D(2)$ (Gy)	
6 (*)	AP	15	14	1.05	11	0.54	1.22	Aug-00	1.85		0.982	1.26	25	31.42			
	PA	15	14	1.05	11	0.54	1.28	Aug-00	1.85		0.982	1.32	25	32.96			
	RLT	11	9.5	1.01	22	0.23	1.29	Aug-00	1.85		0.982	0.55	25	13.79			
	LLT	11	9.5	1.01	22	0.23	1.26	Aug-00	1.85		0.982	0.54	25	13.47			
												3.67	25		91.63	122.15	
7	AP	14.5	13.5	1.05	9	0.65	1.03	Feb-01	1.73		0.982	1.18	25	29.61			
	PA	14.5	13.5	1.05	10.5	0.59	1.06	Feb-01	1.73		0.982	1.10	25	27.51			
30° wedge	RLT	11	9.5	1.01	16	0.39	1.5	Feb-01	1.73	0.72	0.982	0.71	25	17.80			
	LLT	11	9.5	1.01	17	0.36	1.46	Feb-01	1.73	0.72	0.982	0.64	25	16.07			
on lateral fields												3.64			90.98	120.80	
8	AP	15.5	14	1.05	12	0.51	1.24	Dec-00	1.77		0.982	1.16	23	26.59			
	PA	15.5	14	1.05	12	0.51	1.28	Dec-00	1.77		0.982	1.19	23	27.45			
	RLT op	11.5	11	1.02	18	0.32	0.78	Dec-00	1.77			0.45	23	10.30			
	LLT op	11.5	11	1.02	18	0.32	0.87	Dec-00	1.77			0.50	23	11.49			
												3.30			75.83	95.51	
ARC															20.00	20.00	
															95.83	115.51	
9 (*)	AP	15	14	1.05	11	0.55	1.08	Sep-00	1.83		0.982	1.12	27	30.21			
	PA	15	14	1.05	9	0.62	0.98	Sep-00	1.83		0.982	1.14	27	30.90			

TABLE IX. (cont.)

Patient number	Field dir.	Field size	Equiv. square (BF)	FSF (OF)	Depth (cm)	Depth dose (BF)	Time (min)	Date	Dose rate at d_{\max} (Gy/min)	Wedge factor	Tray factor	Dose/fraction	N	Total dose/field (Gy)	Total dose (Gy)	Equiv. $D(2)$ (Gy)
	RLT	11	9.5	1.01	20	0.27	1.12	Sep-00	1.83		0.982	0.55	27	14.80		
	LLT	11	9.5	1.01	20	0.27	0.97	Sep-00	1.83		0.982	0.47	27	12.81		
												3.29			88.73	111.55
10 (*)	AP	15	13.5	1.05	15.5	0.43	1.47	Sep-00	1.83		0.982	1.18	17	20.05		
	PA	15	13.5	1.05	11.5	0.55	1.2	Sep-00	1.83		0.982	1.24	17	21.14		
	RLT	11	9.5	1.01	21.5	0.25	1.37	Sep-00	1.83		0.982	0.61	17	10.34		
	LLT	11	9.5	1.01	21.5	0.25	1.35	Sep-00	1.83		0.982	0.60	17	10.19		
												3.63			61.72	81.85
	RPO	10.5	10.5	1.01	20.5	0.29	1.23	Sep-00	1.83			0.64	8	5.15		
	RAO	10.5	10.5	1.01	16.5	0.38	1.23	Sep-00	1.83			0.85	8	6.78		
	LAO	10.5	10.5	1.01	17	0.37	1.23	Sep-00	1.83			0.82	8	6.59		
	LPO	10.5	10.5	1.01	20.5	0.29	1.23	Sep-00	1.83			0.64	8	5.15		
												2.96			23.67	28.21
															85.39	110.05
11	AP	15	13.5	1.05	14	0.45	1.53	Sep-00	1.83		0.982	1.28	15	19.24		
	PA	15	13.5	1.05	12	0.52	1.38	Sep-00	1.83		0.982	1.35	15	20.28		
	RLT	11	9.5	1.01	20	0.27	1.43	Sep-00	1.83		0.982	0.70	15	10.49		
	LLT	11	9.5	1.01	20	0.27	1.5	Sep-00	1.83		0.982	0.73	15	11.01		
												4.07			61.02	86.26
	RPO	10.5	10.5	1.01	23	0.22	1.31	Sep-00	1.83			0.53	8	4.27		
	RAO	10.5	10.5	1.01	18	0.32	1.13	Sep-00	1.83			0.66	8	5.31		

TABLE IX. (cont.)

Patient number	Field dir.	Field size	Equiv. square (BF)	FSF (OF)	Depth (cm)	Depth dose (BF)	Time (min)	Date	Dose rate at d_{\max} (Gy/min)	Wedge factor	Tray factor	Dose/fraction	N	Total dose/field (Gy)	Total dose (Gy)	Equiv. $D(2)$ (Gy)
	LAO	10.5	10.5	1.01	18	0.32	1.13	Sep-00	1.83			0.66	8	5.31		
	LPO	10.5	10.5	1.01	22	0.24	1.44	Sep-00	1.83			0.63	8	5.08		
												2.50			19.97	21.95
															80.99	108.21
12 (*)	AP	14.5	13.5	1.05	10	0.58	1.06	Sep-00	1.83		0.982	1.15	20	23.05		
	PA	14.5	13.5	1.05	10	0.58	1.06	Sep-00	1.83		0.982	1.15	20	23.05		
	RLT	11	8.5	1.01	18.5	0.30	1.06	Sep-00	1.83		0.982	0.57	20	11.33		
	LLT	11	8.5	1.01	17.5	0.30	0.98	Sep-00	1.83		0.982	0.52	20	10.48		
												3.40			67.92	86.88
	AP	14.5	13.5	1.05	10	0.58	0.41	Dec-00	1.83		0.982	0.45	10	4.46		
	PA	14.5	13.5	1.05	10	0.58	0.41	Dec-00	1.83		0.982	0.45	10	4.46		
	RLT	11	8.5	1.01	18.5	0.30	0.77	Dec-00	1.83		0.982	0.41	10	4.12		
	LLT	11	8.5	1.01	17.5	0.30	0.77	Dec-00	1.83		0.982	0.41	10	4.12		
												1.71			17.15	16.17
															85.07	103.05
13 (*)	AP	16	13	1.06	10.5	0.56	1.1	Nov-00	1.79		0.982	1.15	25	28.66		
	PA	16	13	1.06	11	0.55	1.25	Nov-00	1.79		0.982	1.30	25	32.58		
	RLT	12	12	1.02	20.5	0.28	0.81	Nov-00	1.79			0.41	25	10.34		
	LLT	12	12	1.02	19	0.31	0.72	Nov-00	1.79			0.40	25	10.11		
												3.27			81.69	102.40
14 (*)	AP	15	14.5	1.05	16.5	0.38	1.47	Sep-00	1.83		0.982	1.05	17	17.89		
	PA	15	14.5	1.05	12.5	0.50	1.22	Sep-00	1.83		0.982	1.15	17	19.61		

TABLE IX. (cont.)

Patient number	Field dir.	Field size	Equiv. square (BF)	FSF (OF)	Depth (cm)	Depth dose (BF)	Time (min)	Date	Dose rate at d_{\max} (Gy/min)	Wedge factor	Tray factor	Dose/fraction	N	Total dose/field (Gy)	Total dose (Gy)	Equiv. D(2) (Gy)
	RLT	11	9	1.01	21	0.25	1.42	Sep-00	1.83		0.982	0.63	17	10.72		
	LLT	11	9	1.01	20.5	0.26	1.32	Sep-00	1.83		0.982	0.62	17	10.57		
												3.46			58.79	75.94
	RPO	10.5	10.5	1.01	23	0.22	1.5	Sep-00	1.83			0.61	8	4.85		
	RAO	10.5	10.5	1.01	20	0.28	1.5	Sep-00	1.83			0.77	8	6.13		
	LAO	10.5	10.5	1.01	20	0.28	1.5	Sep-00	1.83			0.77	8	6.13		
	LPO	10.5	10.5	1.01	21	0.25	1.23	Sep-00	1.83			0.56	8	4.52		
												2.70			21.61	24.65
															80.41	100.59
15 (*)	AP	14.5	12.5	1.05	13.5	0.46	1.47	Sep-00	1.83		0.982	1.25	16	20.06		
	PA	14.5	12.5	1.05	13	0.48	1.33	Sep-00	1.83		0.982	1.18	16	18.95		
	RLT	11	9	1.01	21	0.25	1.11	Sep-00	1.83		0.982	0.49	16	7.88		
	LLT	11	9	1.01	20.5	0.26	1.11	Sep-00	1.83		0.982	0.52	16	8.27		
												3.45			55.17	71.15
	RPO	10.5	10.5	1.01	17	0.35	1.14	Sep-00	1.83			0.72	9	6.50		
	RAO	9.5	9.5	1.00	16.5	0.35	1.15	Sep-00	1.83			0.73	9	6.59		
	LAO	9.5	9.5	1.00	17	0.34	0.97	Sep-00	1.83			0.60	9	5.36		
	LPO	10.5	10.5	1.01	18	0.32	1.14	Sep-00	1.83			0.67	9	6.03		
												2.72			24.48	28.00
															79.65	99.15
16 (*)	AP	15	14	1.05	14.5	0.43	1.25	Sep-00	1.83		0.982	1.00	18	18.01		
	PA	15	14	1.05	13	0.48	1.25	Sep-00	1.83		0.982	1.13	18	20.35		

TABLE IX. (cont.)

Patient number	Field dir.	Field size	Equiv. square (BF)	FSF (OF)	Depth (cm)	Depth dose (BF)	Time (min)	Date	Dose rate at d_{\max} (Gy/min)	Wedge factor	Tray factor	Dose/fraction	N	Total dose/field (Gy)	Total dose (Gy)	Equiv. $D(2)$ (Gy)
	RLT	11	10.5	1.01	22.5	0.24	1.33	Sep-00	1.83		0.982	0.57	18	10.19		
	LLT	11	10.5	1.01	18.5	0.31	0.93	Sep-00	1.83		0.982	0.51	18	9.25		
												3.21			57.81	71.81
	RPO	11	11	1.01	22.5	0.24	1.02	Sep-00	1.83			0.44	7	3.10		
	RAO	11	11	1.01	16	0.37	1.54	Sep-00	1.83			1.05	7	7.36		
	LAO	11	11	1.01	16.5	0.35	1.23	Sep-00	1.83			0.79	7	5.56		
	LPO	11	11	1.01	20.5	0.27	1.02	Sep-00	1.83			0.51	7	3.56		
												2.80			19.57	22.69
															77.38	94.50
17	AP	15.5	13	1.05	11.5	0.53	1.14	Dec-00	1.77		0.982	1.10	25	27.61		
	PA	15.5	13	1.05	12	0.51	1.15	Dec-00	1.77		0.982	1.07	25	26.81		
	RLT	12	10.5	1.02	17	0.35	0.79	Dec-00	1.77			0.50	25	12.47		
	LLT	12	10.5	1.02	16	0.37	0.75	Dec-00	1.77			0.50	25	12.51		
												3.18			79.40	98.07
18	AP	16.5	14	1.06	8	0.67	0.8	Sep-00	1.83		0.982	1.01	30	30.41		
	PA	16.5	14	1.06	12.5	0.49	0.94	Sep-00	1.83		0.982	0.88	30	26.33		
	RLT	13.5	12.5	1.04	18	0.34	0.56	Sep-00	1.83		0.982	0.35	30	10.45		
	LLT	13.5	12.5	1.04	16	0.38	0.67	Sep-00	1.83		0.982	0.48	30	14.30		
												2.72			81.48	93.15
19 (*)	AP	14	13	1.04	9.5	0.61	0.97	Sep-00	1.83		0.982	1.06	23	24.42		
	PA	14	13	1.04	9	0.63	0.97	Sep-00	1.83		0.982	1.09	23	25.02		

TABLE IX. (cont.)

Patient number	Field dir.	Field size	Equiv. square (BF)	FSF (OF)	Depth (cm)	Depth dose (BF)	Time (min)	Date	Dose rate at d_{\max} (Gy/min)	Wedge factor	Tray factor	Dose/fraction	N	Total dose/field (Gy)	Total dose (Gy)	Equiv. $D(2)$ (Gy)
	RLT	10	9.5	1.00	15.5	0.38	0.91	Sep-00	1.83		0.982	0.61	23	14.08		
	LLT	10	9.5	1.00	16.5	0.35	0.72	Sep-00	1.83		0.982	0.45	23	10.25		
												3.21			73.76	91.57
20	AP	15.5	14	1.05	12	0.52	1.4	Jan-01	1.75		0.982	1.30	13	16.94		
	PA	15.5	14	1.05	12	0.52	1.38	Jan-01	1.75		0.982	1.28	13	16.70		
	RLT	11.5	10	1.02	17.5	0.33	1.7	Jan-01	1.75		0.982	0.98	13	12.71		
	LLT	11.5	10	1.02	18	0.32	1.7	Jan-01	1.75		0.982	0.94	13	12.21		
												4.50			58.55	87.88
21	AP	15	13.5	1.05	12	0.51	1.05	Sep-00	1.83		0.982	1.01	21	21.18		
	PA	15	13.5	1.05	12	0.51	1.1	Sep-00	1.83		0.982	1.06	21	22.19		
	RLT	11	9.5	1.01	18.5	0.29	1.08	Sep-00	1.83		0.982	0.57	21	11.92		
	LLT	11	9.5	1.01	17.5	0.32	1.02	Sep-00	1.83		0.982	0.59	21	12.42		
												3.22			67.72	84.30
22	AP	15	13.5	1.05	12	0.51	1.32	Jan-01	1.75		0.982	1.21	16	19.41		
	PA	15	13.5	1.05	12	0.51	1.32	Jan-01	1.75		0.982	1.21	16	19.41		
	RLT	12	10.5	1.02	18.5	0.30	1.33	Jan-01	1.75		0.982	0.70	16	11.18		
	LLT	12	10.5	1.02	18.5	0.30	1.33	Jan-01	1.75		0.982	0.70	16	11.18		
												3.82			61.18	83.50
23	AP	15	14	1.05	14.5	0.43	1.34	Sep-00	1.83		0.982	1.10	14	15.34		
	PA	15	14	1.05	11	0.55	1.07	Sep-00	1.83		0.982	1.10	14	15.46		

TABLE IX. (cont.)

Patient number	Field dir.	Field size	Equiv. square (BF)	FSF (OF)	Depth (cm)	Depth dose (BF)	Time (min)	Date	Dose rate at d_{\max} (Gy/min)	Wedge factor	Tray factor	Dose/fraction	N	Total dose/field (Gy)	Total dose (Gy)	Equiv. $D(2)$ (Gy)
	RLT	11	10	1.01	20	0.27	0.81	Sep-00	1.83		0.982	0.40	14	5.63		
	LLT	11	10	1.01	20	0.27	0.81	Sep-00	1.83		0.982	0.40	14	5.63		
												3.00			42.06	50.51
	RPO	10	10	1.00	15.5	0.38	1.33	Sep-00	1.83			0.91	11	10.02		
	RAO	10	10	1.00	17.5	0.33	0.61	Sep-00	1.83			0.36	11	3.98		
	LAO	10	10	1.00	17.5	0.33	1.34	Sep-00	1.83			0.80	11	8.75		
	LPO	10	10	1.00	15.5	0.38	0.61	Sep-00	1.83			0.42	11	4.60		
												2.49			27.36	30.02
															69.42	80.53
24	AP	15	13.5	1.05	11.5	0.52	1.32	Sep-00	1.83		0.982	1.29	11	14.22		
	PA	15	13.5	1.05	13	0.48	1.61	Sep-00	1.83		0.982	1.44	11	15.85		
	RLT	11	9.5	1.01	22.5	0.23	1.18	Sep-00	1.83		0.982	0.49	11	5.41		
	LLT	11	9.5	1.01	23	0.22	1.2	Sep-00	1.83		0.982	0.48	11	5.26		
												3.70			40.74	54.63
	RPO	10.5	10.5	1.01	23	0.23	1.38	Sep-00	1.83			0.57	7	3.99		
	RAO	10.5	10.5	1.01	16.5	0.35	1	Sep-00	1.83			0.65	7	4.55		
	LAO	10.5	10.5	1.01	17	0.34	1	Sep-00	1.83			0.63	7	4.40		
	LPO	10.5	10.5	1.01	23	0.23	1.38	Sep-00	1.83			0.57	7	3.99		
												2.42			16.93	18.34
															57.67	72.97

TABLE IX. (cont.)

Patient number	Field dir.	Field size	Equiv. square (BF)	FSF (OF)	Depth (cm)	Depth dose (BF)	Time (min)	Date	Dose rate at d_{\max} (Gy/min)	Wedge factor	Tray factor	Dose/fraction	N	Total dose/field (Gy)	Total dose (Gy)	Equiv. $D(2)$ (Gy)	
25 (*)	AP	16	13	1.06	11.5	0.52	0.82	Dec-00	1.77		0.982	0.78	18	14.03			
	(Off-axis PA	16	13	1.06	12.5	0.49	1.03	Dec-00	1.77		0.982	0.92	18	16.60			
	contour RLT	10.5	10.5	1.01	17.5	0.33	0.78	Dec-00	1.77			0.46	18	8.23			
	-3.5 cm) LLT	10.5	10.5	1.01	17	0.34	0.78	Dec-00	1.77			0.48	18	8.56			
												2.63			47.42	53.44	
26	AP	15.5	13	1.05	10.5	0.57	1.19	Feb-01	1.73		0.982	1.21	15	18.19			
	PA	15.5	13	1.05	10.5	0.57	1.19	Feb-01	1.73		0.982	1.21	15	18.19			
30° wedge on lateral fields	RLT	11	8.5	1.01	18.5	0.30	1.68	Feb-01	1.73	0.72	0.982	0.61	15	9.17			
	LLT	11	8.5	1.01	19	0.28	1.73	Feb-01	1.73	0.72	0.982	0.61	15	9.09			
												3.64			54.63	72.58	
27	AP	15	13.5	1.05	8.5	0.64	0.96	Feb-01	1.73		0.982	1.10	17	18.74			
	PA	15	13.5	1.05	9.5	0.60	0.96	Feb-01	1.73		0.982	1.03	17	17.46			
	RLT	12	9	1.02	16	0.36	1.22	Feb-01	1.73	0.72	0.982	0.55	17	9.31			
	LLT	12	9	1.02	16.5	0.35	1.22	Feb-01	1.73	0.72	0.982	0.53	17	9.05			
												3.21			54.56	67.75	
28	AP	16.5	15	1.06	11	0.55	1.11	Nov-00	1.79		0.982	1.14	6	6.87			
	PA	16.5	15	1.06	10.5	0.58	1.11	Nov-00	1.79		0.982	1.19	6	7.14			
	RLT	13	12	1.03	19.5	0.29	0.84	Nov-00	1.79			0.45	6	2.69			
	LLT	13	12	1.03	17.5	0.34	0.84	Nov-00	1.79			0.53	5	2.65			
												3.31			19.35	24.44	

Note: An asterisk indicates that the patient received an additional brachytherapy treatment, and therefore the doses to the bladder and rectum are higher than the values in this table.

5.4.4. Other patients treated in the same period

The patients affected by this event are assumed to be the 28 identified as having been treated with the entry of multiple block data as if they were a single block, describing two loops in the same direction. For other patients whose treatment plans were not obtained using this method, the treatment times were assumed to be correct, i.e. the time needed to deliver the prescribed dose was not affected by the incorrect calculations.

During the mission it was not possible to evaluate all patients treated in the same period (about 500 patients) and only a spot check was performed on ten patients treated for prostate cancer and cancers of the cervix. A full dose determination was not done but only the treatment times were checked, These are listed in the last column in Table X, which shows that the treatment times for these patients were about half of the treatment times used for the 28 overexposed patients, as can be seen from Table IX.

TABLE X. REVIEW OF CHARTS AND TREATMENT TIMES FOR SOME OTHER SELECTED PATIENTS WHO WERE TREATED USING THE TPS AT THE ION BETWEEN JULY 2000 AND FEBRUARY 2001

Patient No.	Cancer	Date	Treatment times (min) for fields treated
A	Prostate	20 Jul.–30 Aug. 2000	0.7, 0.7, 0.3, 0.25
B	Prostate	11 Jul.–11 Aug. 2000	0.6, 0.6, 0.6, 0.6
C	Prostate, 4 blocks used	31 Jul.–4 Sep. 2000	0.6, 0.7, 0.5, 0.5
D	Prostate	24 Jul.–25 Aug. 2000	0.6, 0.6, 0.6, 0.9
E	Prostate	10 Oct.–15 Nov. 2000	0.5, 0.6, 0.6, 0.5
F	Prostate	23 Oct.–29 Nov. 2000	0.6, 0.7, 0.5, 0.5
G	Prostate	27 Oct.–6 Dec. 2000	0.6, 0.7, 0.6, 0.5
H	Cervix	30 Aug.–6 Oct. 2000	0.8, 0.8, 0.8, 0.8
I	Cervix, 4 blocks used	14 Aug.–19 Sep. 2000	0.6, 0.8, 0.5, 0.6
J	Cervix	6 Feb.–14 March 2000	0.8, 0.6, 0.8, 0.8

Note: These values are related to the individual fields.

6. TEST OF THE COMPUTER SOFTWARE USING DIFFERENT APPROACHES FOR DATA ENTRY

The evaluation in Section 5 confirmed that the input data used by ION physicists for computer calculations were valid in the cases tested. It also showed that the TPS gave accurate output in these cases, which included open fields, wedged fields and fields with shielding blocks. The purpose of the tests described below was to further investigate the performance of the TPS in dose calculations for blocked fields, in particular for the entry of multiple blocks as a single block with a double loop.

6.1. INSTRUCTIONS AND WARNINGS

The manufacturer's disclaimer in the TPS manual [16] states that the TPS RTP/2 is a "DECISION SUPPORT SYSTEM, designed to evaluate possible dose calculations based on the user supplied radiation beam and patient geometric data as well as user selected algorithms and control parameters". It further states that "it is the responsibility of the user to validate any RESULTS obtained with the system and CAREFULLY check if data, algorithms and settings are meaningful, correct or applicable, PRIOR to using the results as a part of the decision making process to develop, define or document a course or treatment. In particular, a USER SHOULD VERIFY THE RESULTS OBTAINED THROUGH INDEPENDENT MEANS AND EVALUATE ANY DISCREPANCIES CAREFULLY until the USER'S PROFESSIONAL CRITERIA HAS BEEN SATISFIED."

The team examined the instructions in the manual relating to the blocked fields in order to understand the method of entering block data into the system. The manual states, in the section entitled 'Beam Handling and Field Set up', subsection 'Block', this function allows for entry of up to 4 blocks of 32 points per beam" and "once the block is nearly finished, strike enter to close the block contour"; however, no instructions on how to digitize the block contours are given.

Later in the manual, the section on computational methods describes the algorithm for block calculation. The manual states in this section, instead of in the section giving instructions for data entry, that "each block is considered to be a separate field outline and the outline entered into the system is automatically clipped to the rectangle defined by the collimator jaws". In the section 'Block Calculations', it states that "the calculation is symmetric with respect to whether the outline goes clockwise or counter clockwise". This, in summary, is the information available to the user, placed in different sections of the manual, from which he/she can infer how to enter the blocks.

6.2. TESTS PERFORMED

Following the instructions described above, the user may conclude that block co-ordinates should be digitized separately for each individual block, as shown in Fig. 6. However, as shown in Section 3 of this report, it is also possible to enter the co-ordinates of several blocks as a single block, as shown in Fig. 7, completing the inner loop with a loop over the contour of the initial open field. In this case, the user receives no warning that he/she is violating the instructions.

In order to investigate the effect of the procedure of entering block co-ordinates into the TPS, the following study was carried out using the 'External Beams' option. The first calculation was done for an open 15 cm \times 15 cm field, with the central axis of the beam perpendicular to the phantom surface. The TPS printout of the dose distribution for the central plane of the field is given in Fig. 8. An arrow shows the position of the 50% isodose.

The next calculation was performed for a 15 cm \times 15 cm field beam with four shielding blocks with 5% transmission, i.e. the dose from radiation passing the block is 5% of the dose without the block (this transmission value is typically used in radiotherapy and was employed at the ION). The co-ordinates of each block were digitized separately, as shown in Fig. 6. The transmission factor was also entered for each block separately. The resulting dose distribution for the central plane of the field is given in Fig. 9. This shows the calculated dose distribution for the blocked field, with a diagram indicated by an arrow showing the blocks and their positions in the field. Figure 10 shows the dose distributions for open and blocked fields: it is clear that the inclusion of blocks in the corners of the field has not significantly influenced the dose distribution in the central plane of the beam. The 50% isodose line is at approximately the same depth in both cases.

The same arrangement of blocks with the same transmission was used in the third calculation, but this time the co-ordinates of the blocks were digitized as a single block describing two loops, as shown in Fig. 6. The calculated dose distribution is shown in Fig. 11. The diagram on the right of the figure again shows the blocks and their positions in the field. Note that the diagram shows the shielding blocks correctly positioned. A comparison of the dose distributions for the two methods of entering block data into the TPS is given in Fig. 12. This shows a dramatic change in dose distribution for the case when block contours were entered as if it were a single block, describing two loops in the same direction. In this case the 50% isodose is much nearer the surface of the phantom, demonstrating a steeper decrease of the depth dose as compared with the previous calculation.

It is possible to enter the co-ordinates of the multiple blocks as for a single block, but to make the second loop in the opposite direction to the first one, as shown in Fig. 13. In this case the TPS produces the dose distribution shown in Fig. 14, again with the diagram of the block positions to the right of the figure. This dose

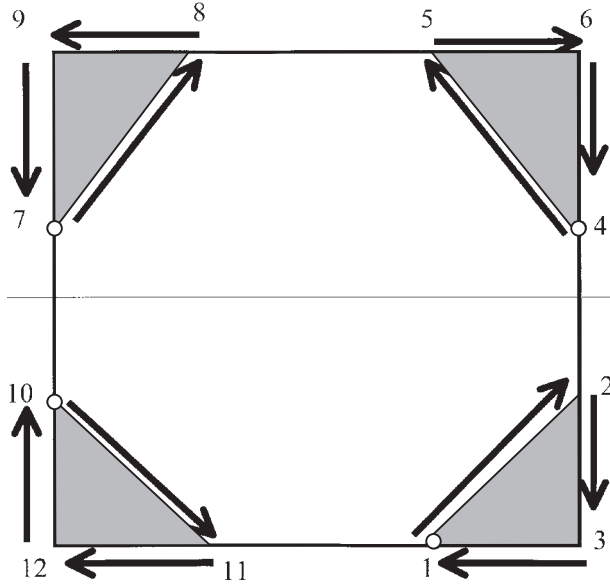

FIG. 6. Digitizing the co-ordinates of each block separately. The shaded areas denote the blocks.

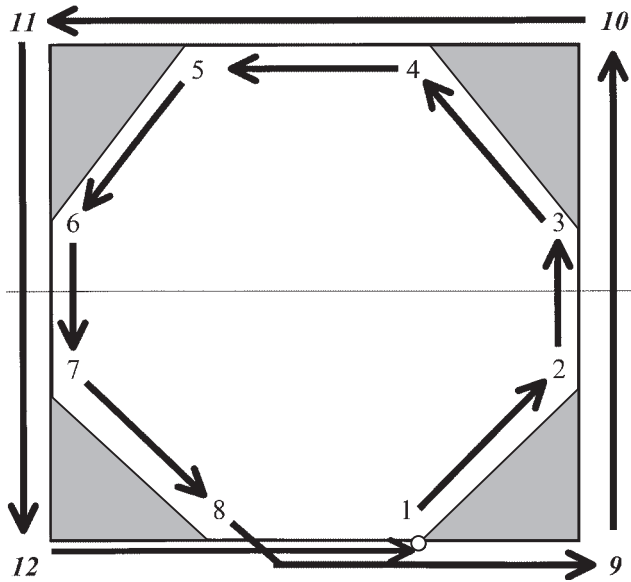

FIG. 7. Digitizing co-ordinates of multiple blocks as a single block describing two loops in the same direction. The shaded areas denote the blocks.

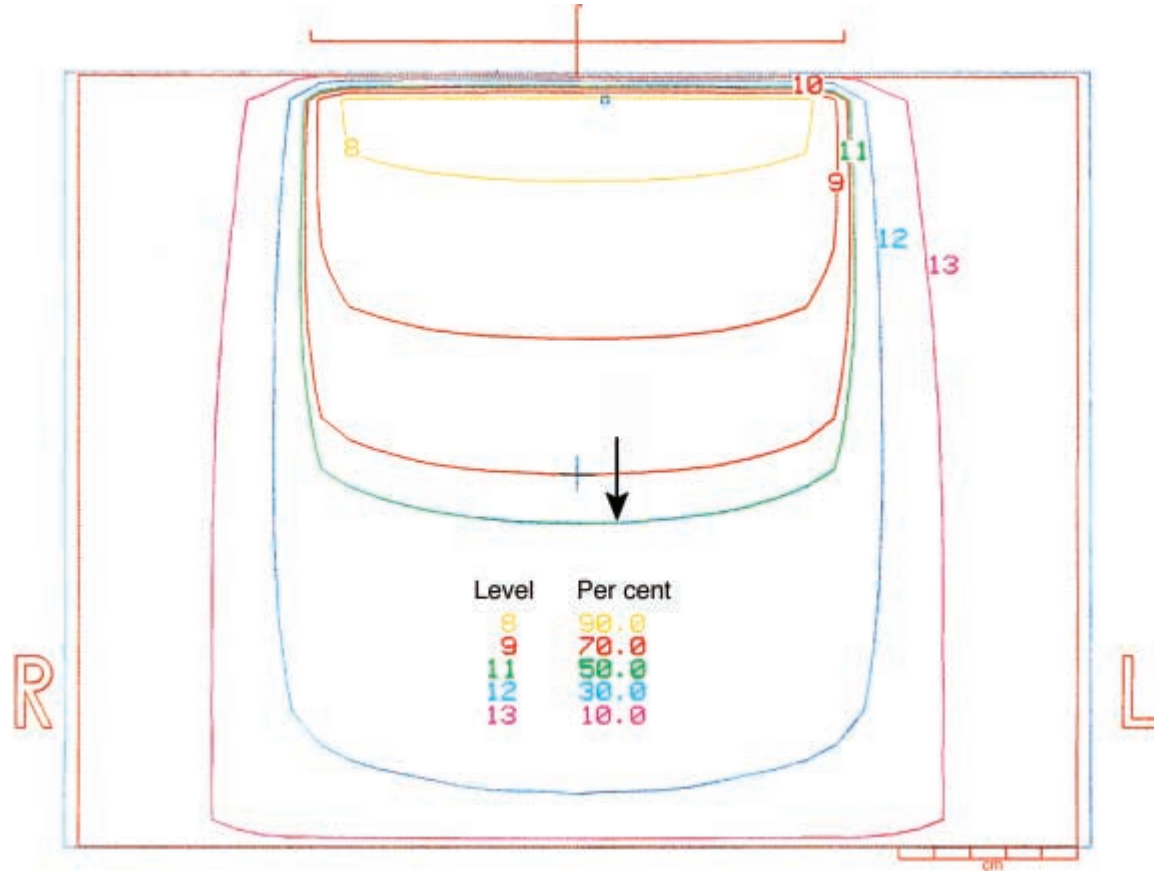

FIG. 8. Isodose distribution in the central plane for an open field (arrow shows position of the 50% isodose).

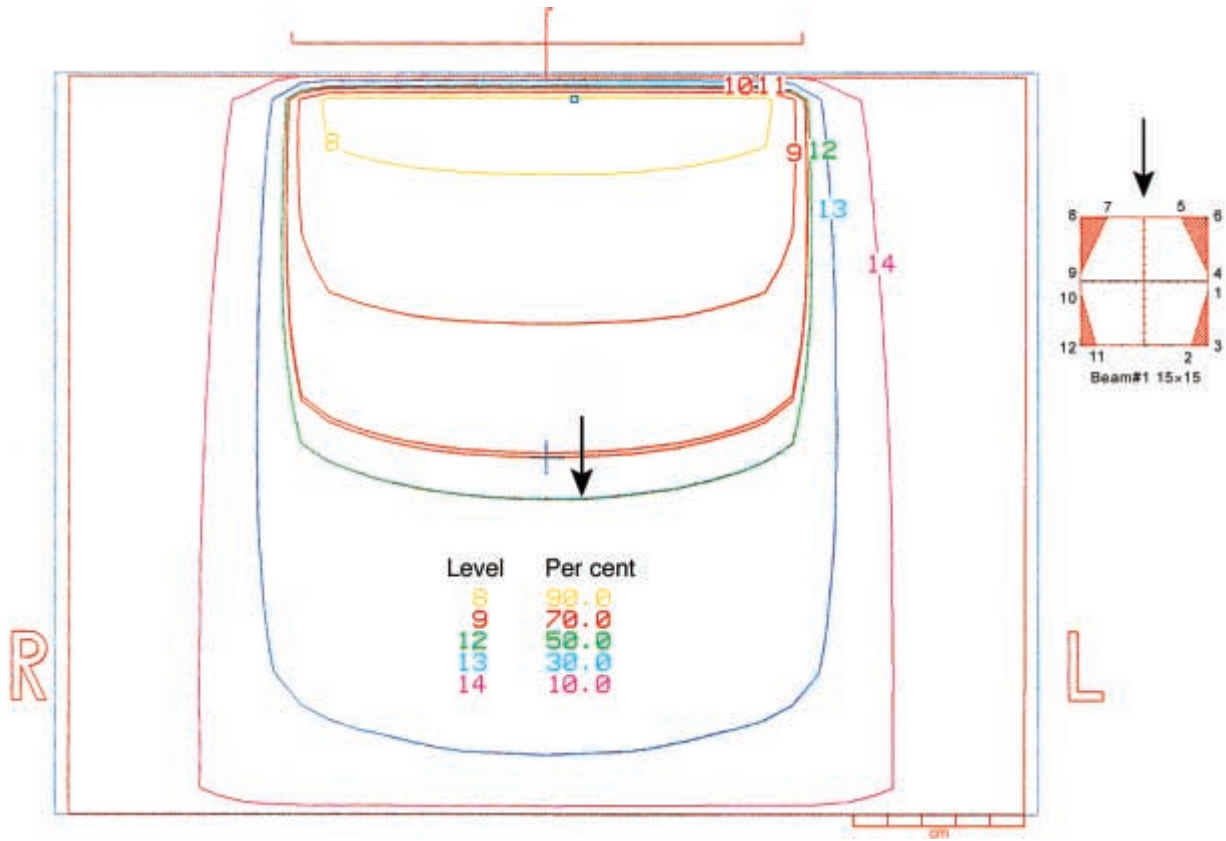

FIG. 9. Isodose distribution in the central plane for a blocked field when the co-ordinates of each block were digitized separately (the arrow at the centre shows the position of the 50% isodose; the arrow to the right shows the diagram of the block's position).

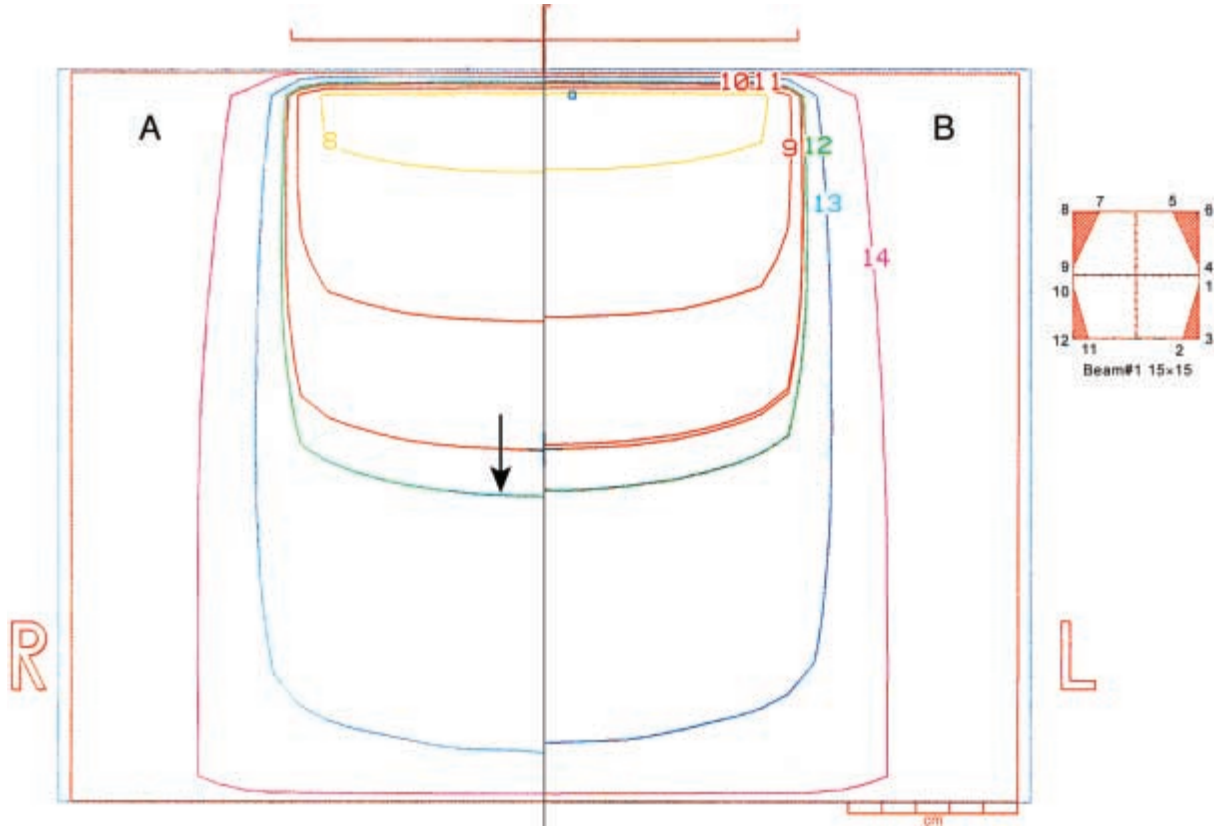

FIG. 10. Comparison of isodose distributions in the central plane for open field (A) and for a blocked field when the co-ordinates of each block were digitized separately (B) (the arrow at the centre shows the position of the 50% isodose).

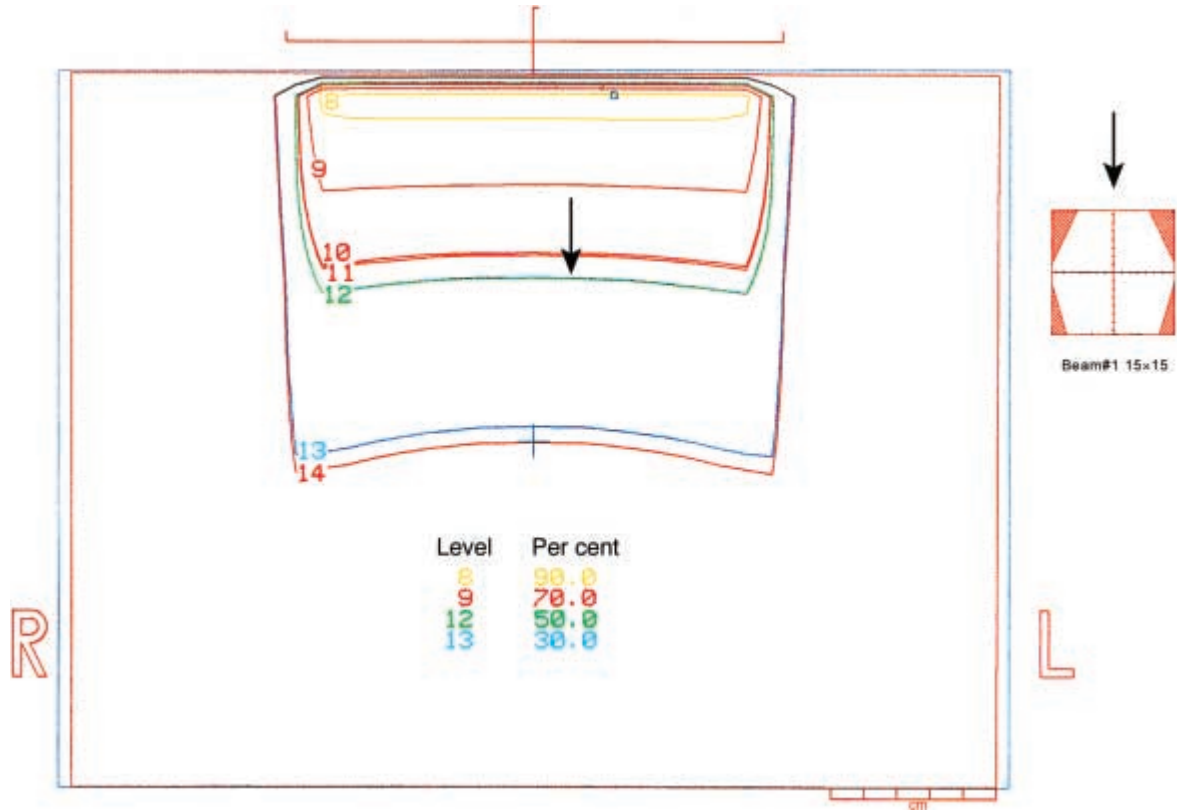

FIG. 11. Isodose distribution in the central plane for a blocked field when the co-ordinates of multiple blocks were digitized as a single block, describing two loops in the same direction (the arrow at the centre shows the position of the 50% isodose; the arrow to the right shows the diagram of the block's position).

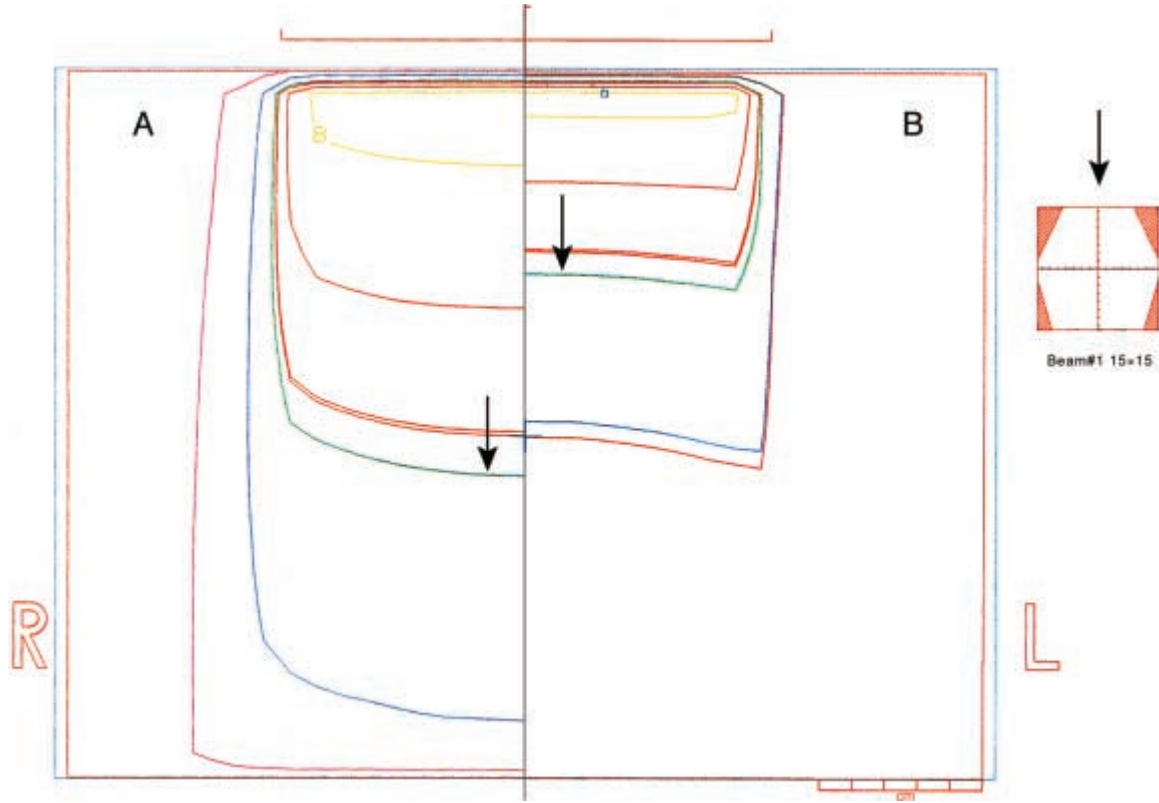

FIG. 12. Comparison of isodose distributions in the central plane for a blocked field when the co-ordinates of each block were digitized separately (A), and for a blocked field when the co-ordinates of multiple blocks were digitized as a single block, describing two loops in the same direction (B) (the arrows in the centre show the position of the 50% isodose for each case).

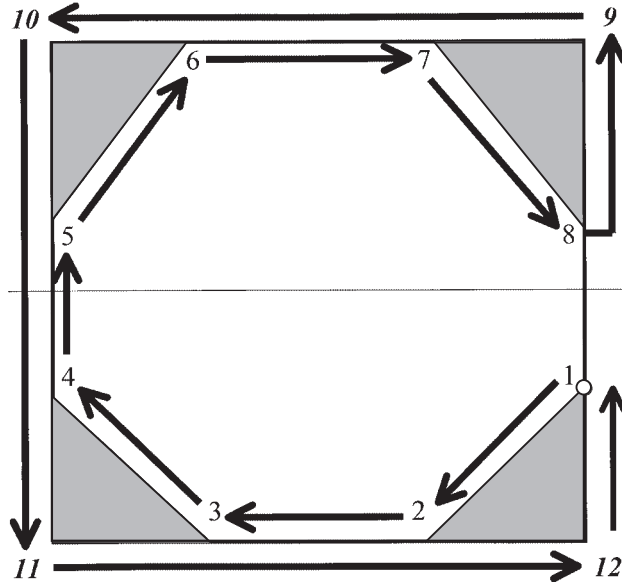

FIG. 13. Digitizing co-ordinates of multiple blocks as a single block, but with the loops in opposite directions (one loop clockwise and the other one counterclockwise).

distribution is very similar to the normal ones, i.e. the dose distribution for an open field (Fig. 8), and for the case when the block data were entered separately for each block (Fig. 10). There is only a slight distortion of the penumbra region on the right side of the phantom, as indicated by the arrow.

These results show that the TPS permits the entry of the co-ordinates in the blocks in several different ways. One specific way of entering the block co-ordinates, shown in Fig. 7, gives very different results than the others.

The next test was intended to find out whether it is the use of a double loop in the same direction, irrespective of the number and size of the blocks, that causes the error in the calculation. If only a small part of one corner of an open field is blocked, the block should have no significant influence on the dose distribution in the central plane. Such a field is shown in Fig. 15, where a double loop entry of one block's co-ordinates is outlined. The calculated dose distribution is presented in Fig. 16, again with a diagram on the right showing the block and its position in the field. The resulting dose distribution is clearly incorrect and very much similar to the results presented in Fig. 9. This demonstrates that a double loop entry causes an incorrect calculation even when only co-ordinates of one block are digitized.

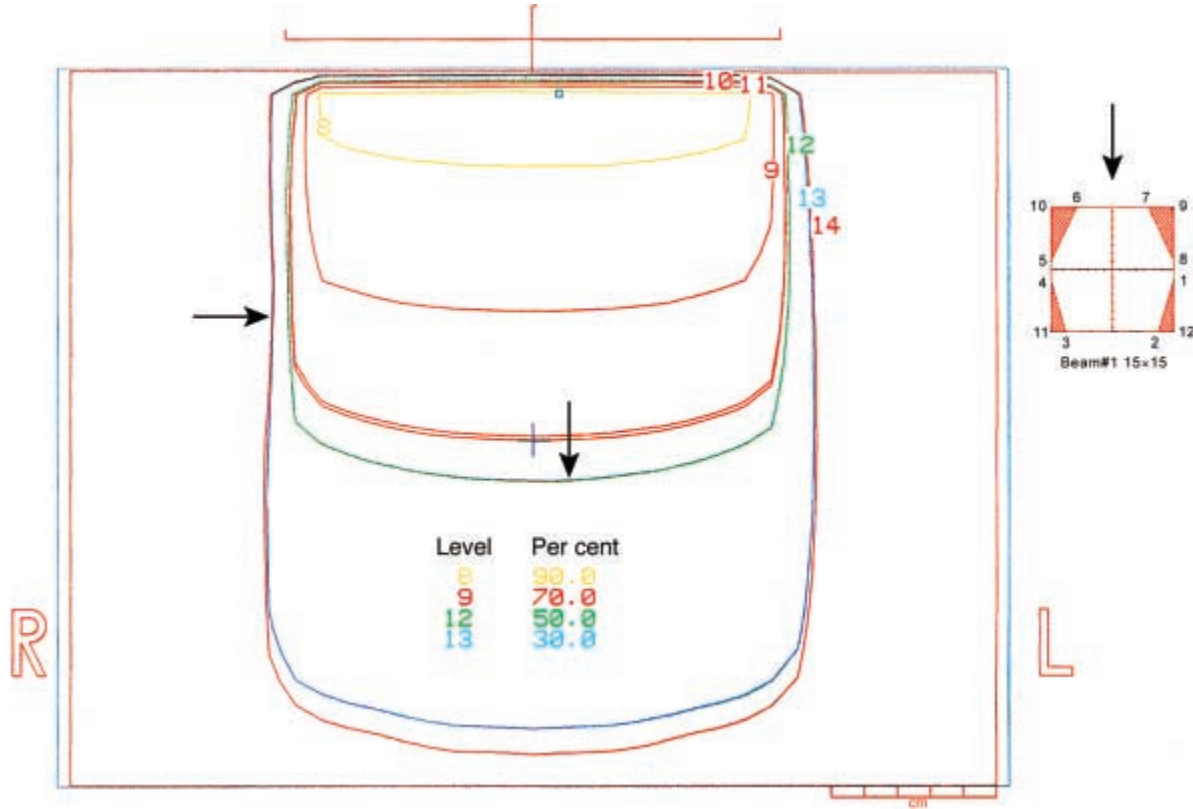

FIG. 14. Isodose distribution in the central plane for a blocked field with the co-ordinates of multiple blocks digitized as a single block with the loops in the opposite directions (one loop clockwise and the other one counterclockwise) (the arrow on the left shows the distortion of the penumbra; the arrow in the centre shows the position of the 50% isodose; the arrow on the right shows the diagram of the block's position).

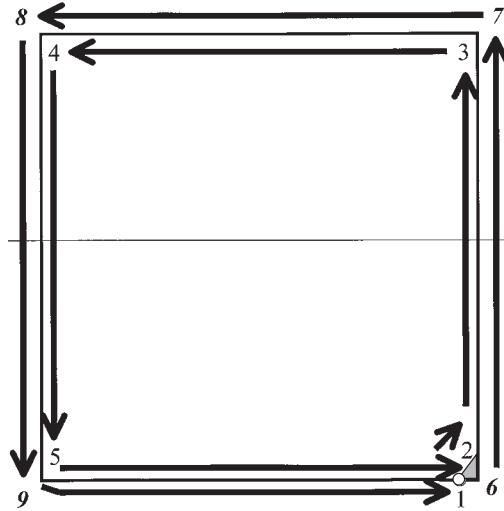

FIG. 15. Digitizing co-ordinates of a small corner block describing two loops in the same direction. The shaded area denotes the block.

As a final step, the central axis depth dose distributions were calculated for beams with the geometries shown in Fig. 17:

- Open 15 cm × 15 cm field,
- 15 cm × 15 cm field with small corner block,
- 15 cm × 15 cm field with one block,
- 15 cm × 15 cm field with two blocks,
- 15 cm × 15 cm field with four blocks.

This experiment was intended to show whether the value of the block transmission influences the depth dose distribution in the open part of the field. Calculations were performed for blocks with different transmissions, e.g. for 5, 50 and 90% block transmission. In all cases the co-ordinates of the blocks were digitized as a single block describing two loops in the same direction. Analysis of the results showed that the gradients of the depth dose distributions depended on the transmission values assigned to the blocks and the central axis depth dose distributions for the blocked fields with the same transmission value were very close irrespective of the size and shape of the blocked area shown in Fig. 17.

Figure 18 shows the central axis depth dose distributions for an open field and for a blocked field, with a 5% transmission; this was the block transmission for the calculation of the affected patients. The depth dose calculated at 10 cm depth for the blocked field, when the block is entered describing two loops in the same direction, is lower by a factor of 2 than the depth dose for the open field and for the field where

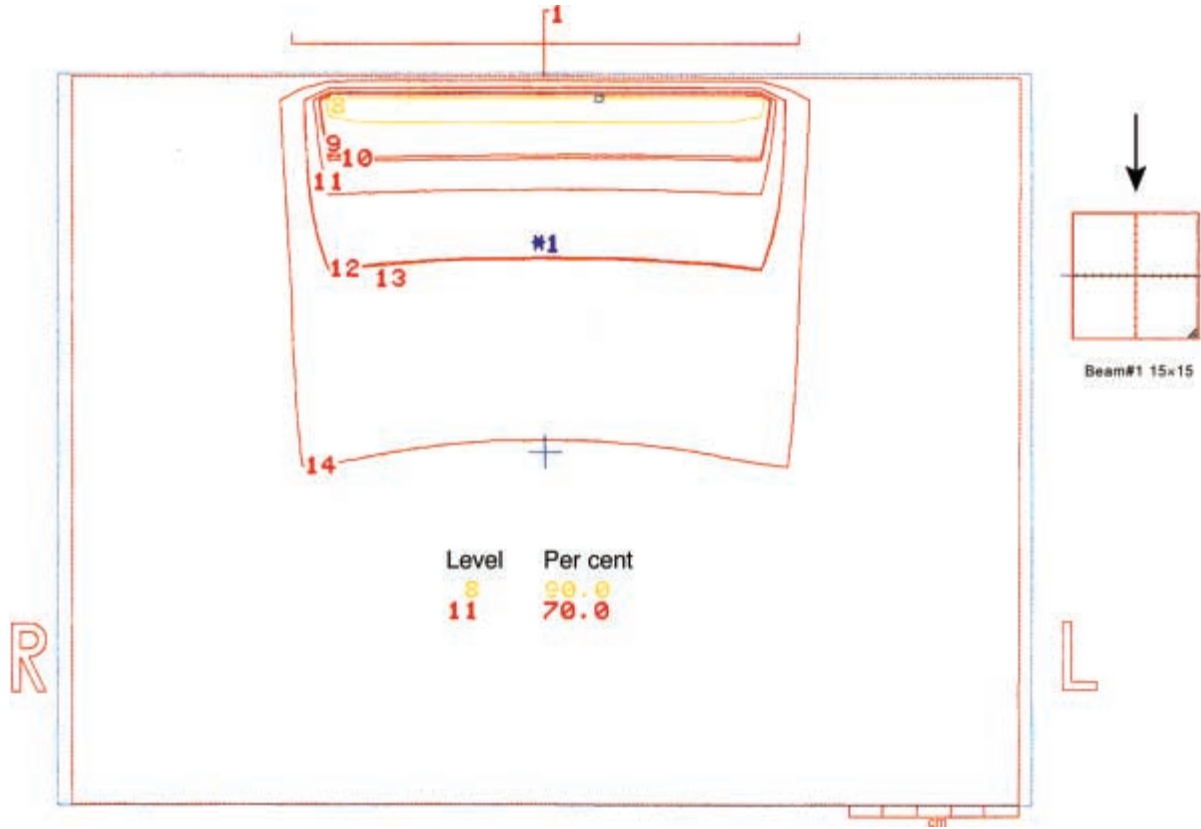

FIG. 16. Isodose distribution in the central plane for a blocked field when the co-ordinates of a small corner block were digitized describing two loops in the same direction (the arrow in the centre shows the position of the 50% isodose; the arrow to the right shows the diagram of the block's position).

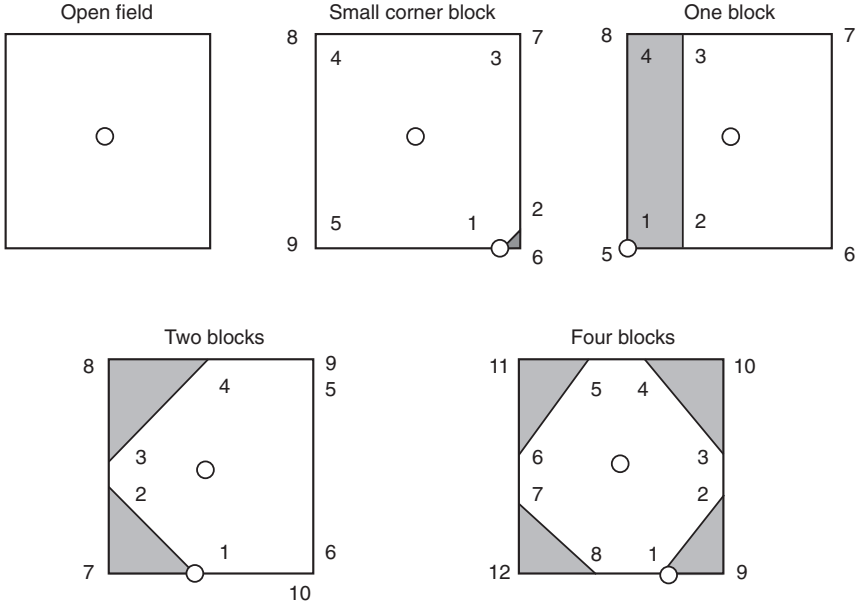

FIG. 17. Beam arrangements used in the numerical experiment. The shaded areas denote the blocks. The numbers show the sequence for digitizing the co-ordinates of the blocks.

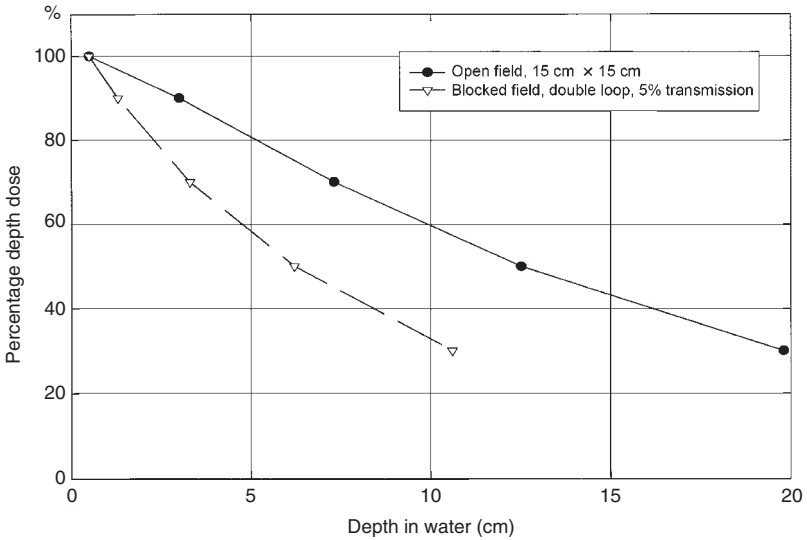

FIG. 18. TPS calculated central axis depth doses for an open field and for a blocked field with 5% block transmission, when multiple blocks are entered as a single block describing two loops in the same direction.

the co-ordinates of the blocks are digitized separately. This effect causes the TPS to calculate a doubled treatment time for the delivery of a prescribed dose when data are entered with a double loop, both loops being in the same direction.

The results of the tests of data entry into the TPS indicate that the use of double loop entry, with the two loops in the same direction, produces incorrect results, with a steeper gradient in the calculated depth dose distribution than the gradient in the dose distribution when the co-ordinates of the blocks are entered separately for each block.

7. MEDICAL ASSESSMENT

7.1. BACKGROUND INFORMATION ON RADIATION EFFECTS IN HUMANS

Radiation effects in humans are caused by the deposition of energy in tissue. Sufficiently high doses of radiation cause the death of cells. Not all cells are of equal radiosensitivity. In general, cells with a high DNA content and rapidly dividing cells such as those in the testis, skin, epithelium of the pharynx and larynx, intestinal lining and bone marrow are the most sensitive. Blood vessels are of medium radiosensitivity, and bone and brain are less sensitive.

Clearly, the pathological changes identified after irradiation of a given organ depend not only upon the physical parameters of the exposure, but also upon the radiosensitivity of the various organ components. In cases where the parenchymal (functional) cells of the organ are radiosensitive, loss of function of these cells will be the initial critical factor, although later vascular compromise may become important. After substantial radiation exposure, failure of the organ system may result relatively quickly. An example of an organ system with very sensitive parenchymal cells is the gastrointestinal system. Marked abnormalities can be seen within several days after a relatively moderate dose of radiation.

When the irradiated organ has parenchymal cells that are part of a slow renewal system, the controlling factor is the more sensitive connective tissue cells, such as the microcirculation supplying blood to the parenchymal cells. An example of such an organ is the brain.

One can divide the clinical manifestations of radiation injury into periods of arbitrary length. The *acute clinical period* is the first six months; the *subacute period* is 6–12 months; the *chronic clinical period* is 12 months to 5 years; with the *late clinical period* being greater than five years after irradiation.

The *acute clinical period* includes the initial destructive processes and various repair processes of the organ system. Whether the organ actually survives depends on the total dose, the volume of the organ irradiated, radiosensitivity and physical and chemical parameters. If the radiation dose is high enough, the tolerance of the organ parenchyma will be exceeded, and failure of that system during the acute period will result. With lesser exposures, there may be some parenchymal damage, and the organ may recover either full or partial function. If the parenchymal cells of the organ are relatively radioresistant, no changes may be observed during the acute period. However, this should not be construed as indicating that no clinical radiation damage will result. Vascular changes as a result of arteriolar narrowing may occur later with associated complications. Vascular changes are often responsible for the limiting dose that may be given to an otherwise radioresistant organ.

In the *subacute period*, underlying radiation damage in parenchymal cells may become manifest in terms of clinically significant problems. These may also be complicated by vascular deterioration due to fibrosis, myointimal proliferation, and hyaline sclerosis of the subintimal and medial regions of small arteries and arterioles.

During the *chronic clinical period*, an organ system may demonstrate further deterioration of vascularity and secondary degeneration of the parenchyma that can lead to decreased resistance to various sorts of stress.

In the *late clinical period*, there is a slow progression of residual radiation damage and formation of dense fibrous tissue due to hypoperfusion. A major problem identified in this late period is radiation carcinogenesis.

At the time of the team's initial examination of the patients, they had already experienced the acute clinical period and part of the subacute period, but additional changes are to be expected.

7.2. BASIC RADIOTHERAPY PRINCIPLES RELEVANT TO THIS ACCIDENTAL EXPOSURE

Radiotherapy is the use of ionizing radiation to kill tumour cells in the body. Usually a radiation source outside the body is used to direct a beam of radiation to the area of the tumour. The beam of radiation deposits energy in the tissues and kills cells in the area of the beam but not elsewhere. The effects of radiation therefore will be limited to tissues or organs in the beam. As an example, a patient who was overexposed to the pelvis will not have headaches or arm pain as a result of radiation.

When the energy from an external radiation beam is deposited in tissues, cells may be damaged or killed, but the radiation exposure does not make the tissue or the patient radioactive. It is completely safe for patients overexposed in this event to be around other persons and even to hold children. An analogy would be someone who was burned in a fire. Such patients do not burn other people when they touch them.

Sometimes patients and families of patients who were accidentally overexposed do not understand this principle and wonder whether it is safe for them to be near family members or children.

7.3. FRACTIONATION OF RADIATION EXPOSURE

Fractionation of radiation exposure, or protraction of the dose over a period of time, almost always reduces the effect of the dose. Spreading a radiation dose out over days or weeks allows time for the cells to repair radiation damage. In radiotherapy it is hoped that the normal tissue will repair faster than the tumour tissues, thus allowing the tumour to be killed while normal tissues are less affected. If a radiation dose is very protracted there is even less effect because not only is there repair, there is also cellular repopulation due to continued cellular division. In this accidental exposure, the doses of each treatment were too high, and this resulted in less repair and cellular repopulation (and more complications and adverse effects) than would have been expected from the doses prescribed by the radiation oncologist. The situation is similar to a physician writing a prescription for two small pills a day of a somewhat toxic drug, but the pharmacy actually gives the patient two large pills per day.

Doses given in different fractionations can be compared in terms of the level of tissue effects they cause. In order to compare the effects of a treatment regimen (with an unusual dose per fraction) with that which would occur from a typical treatment regimen of 2 Gy per fraction, it is necessary to calculate the 2 Gy per fraction equivalent dose, i.e. the total dose that would lead to the same biological effect if given in fractions of 2 Gy each instead of the actual fractions delivered [17].

7.4. ADVERSE EFFECTS

It should be noted that even excellent radiotherapy practice cannot kill a tumour without causing some damage to normal tissues. There is a very narrow range of doses and numbers of treatments within which the radiation oncologist must work. If the treating physician does not damage normal tissue to some extent, then there will be very few tumours cured. In order to be able to cure tumours, radiation oncologists use doses that will result in some complications in about 5% of the patients (the acceptability depends on the type of complication). This is regarded as acceptable practice in order to be able to cure cancers. However, a small increase in dose above standard protocols will result in a high complication rate.

The incidence of adverse radiation effects or complications at different radiation therapy dose levels is well known for most tissues. This is expressed as a 'tolerance dose' (TD), and the complications are expressed as the percentage of

patients who will develop the adverse effect over a specific period of time. The TD 5/5 refers to the dose that will result in up to a 5% complication rate in five years. In a similar fashion, the TD 50/5 refers to the dose that will cause complications in up to 50% of exposed persons in 5 years. Tolerance doses for tissues of interest in this accidental exposure are shown in Table XI.

7.5. SPECTRUM OF OVEREXPOSURES IN THIS EVENT

In this accidental exposure there is a spectrum of how much overexposure actually occurred. Curative radiotherapy protocols usually involve 20–25 treatments. In this accidental exposure, while a few patients were not able to tolerate the treatment, and interrupted it, most received the full treatment. The doses delivered in each fraction were approximately double the normal ones, and thus patients who followed the full course of treatments received a 100% increase in dose. There was one patient who only had six treatments and then went to another hospital to complete therapy. This patient had a total overexposure for his entire treatment of approximately 20% and no catastrophic complications are expected. The patients who terminated treatment early because of either severe reactions or personal reasons received excess doses of about 50–70%.

As an example, Fig. 19 [19] shows the incidence of severe proctitis versus radiation dose to rectum and the doses occurred in this overexposure. Figure 20 shows the dependence of severe large bowel complication on radiation dose in patients treated for testicular cancer and its relation with the doses of this overexposure.

TABLE XI. TOLERANCE DOSES (Gy) FOR TISSUES OF INTEREST IN THIS ACCIDENTAL EXPOSURE (DATA ADAPTED FROM REF. [18])

Tissue	Injury (at 5 years)	TD 5/5: Dose (Gy) giving 1–5% complications	TD 50/5: Dose (Gy) giving 25–50% complications	Volume, area or length of tissue irradiated
Skin	Ulcer, severe fibrosis	55	70	100 cm ²
Small intestine	Ulcer, perforation	50	65	100 cm ²
Colon	Ulcer, stricture	45	65	100 cm ²
Rectum	Ulcer, stricture	55	80	100 cm ²
Bladder	Ulcer, contracture	60	80	Whole
Uterus	Necrosis, perforation	>100	>200	Whole
Vagina	Ulcer, perforation	90	>100	5 cm

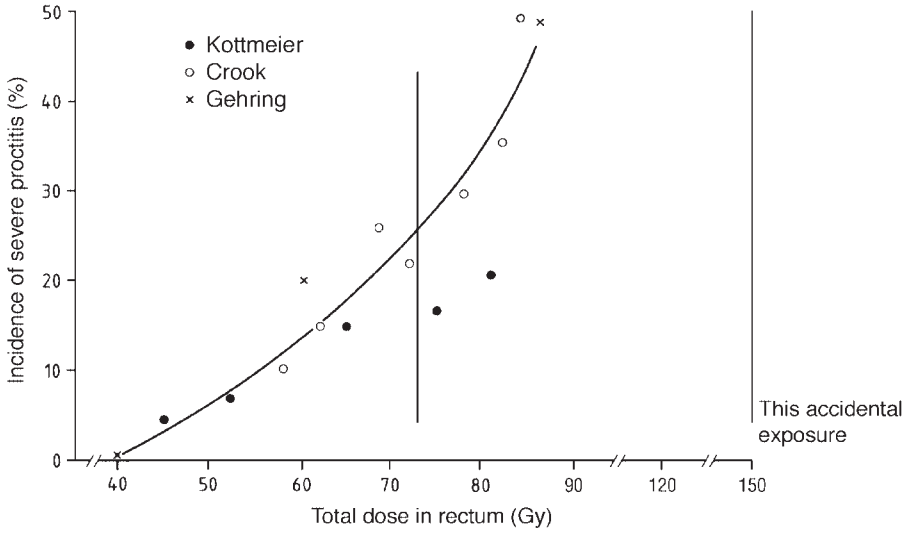

FIG. 19. Incidence of severe proctitis versus radiation dose to the rectum (adapted from Sherer and Streffer [17]) and its relation to the doses of this accidental exposure.

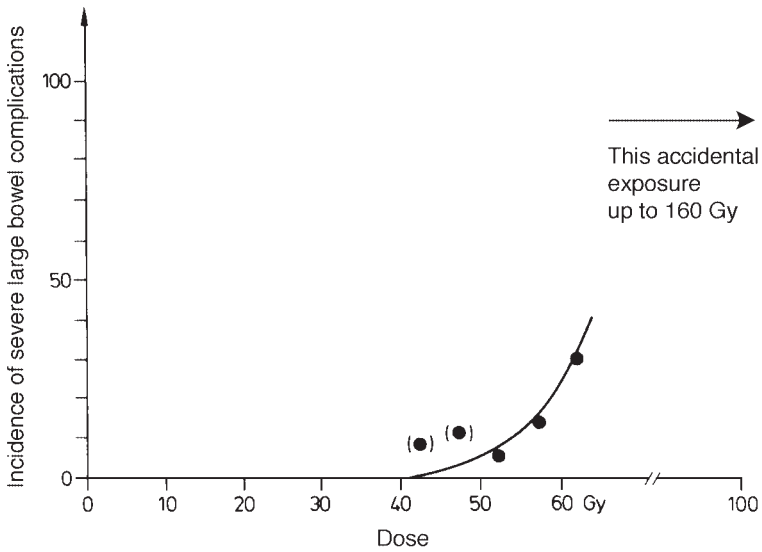

FIG. 20. Dependence of severe large bowel complications on radiation dose in patients treated for testicular cancer [19, 20] and its relation to the doses of this accidental exposure.

7.6. COMPLICATING FACTORS IN THE EVALUATION OF THIS EVENT

There are at least two complicating factors in the medical evaluation of both the surviving and expired patients. In most cases, no portal films are available to show the location of the radiation treatment beam on the body, although pretreatment radiographs are available for most patients. For patients who are still alive, the field location can almost always be ascertained by clinical examination of the subcutaneous fibrosis, skin pigmentation and loss of hair.

A second complicating factor in the evaluation of some of the patients was the presence of other conditions that increase radiation risk such as prior or subsequent treatment either with surgery or chemotherapy. Usually the complications and side effects could be distinguished by knowledge of the effects of the specific drugs, the time the effect occurred and knowledge of the type and timing of radiation effects relative to exposure. There were at least two patients with diabetes mellitus, which is known to increase the incidence and severity of adverse radiation effects.

7.7. RESULTS OF THE MEDICAL TEAM'S INVESTIGATION

In this accidental exposure, methods of entering data were used with the TPS that caused the computer to produce unusual isodose curves and calculate treatment times that were longer than needed to give the prescribed dose to 28 patients. Therefore, longer times than appropriate were used in the daily treatments. This resulted in too much energy being deposited in both the normal tissues and the tumour. Overexposure resulted in excessive cell killing and also scarring and damage of the tissues and underlying blood vessels.

It should be noted that most of the approximately 500 patients treated between August 2000 and February 2001 appear to have received the correct doses. In addition to the incorrect data entry method, the technologists apparently did not notice that in patients with similar diseases and treatment fields, the treatment times of some patients were approximately twice those of others. Finally, some of the 28 patients had inordinately severe early reactions, causing the treatment to be paused or even halted. It was only after this had happened a number of times, and there had been some early deaths, that the cause was determined.

The summary data for both surviving and deceased patients are shown in Table XII. The table is organized by absorbed dose in descending order. Severe complications are often seen when the 2 Gy per fraction equivalent dose exceeds 65–70 Gy (Table XIII). Also, note that treatment times for most other patients with similar treatment at the same time was about 0.6 min per AP/PA fields (see Table A–III in Annex III).

TABLE XII. DATA ON THE 28 PATIENTS. THE DOSES ARE FROM EXTERNAL BEAM TREATMENTS

Patient No.	Age ^a and sex	Tumour	Treatment times (min)	Dose to beam intersection point (Gy)	2 Gy Equiv. dose	Current symptoms ^a (days after last treatment)	Other findings
1	Middle aged M	Prostate Ca Grade 1–2 Nodes negative	1.5, 1.8, 1.3, 1.4, 1.2, 1.2, 1.4, 1.2	111	140	Treatment stopped due to early reactions. (152 days)	Persistent diarrhoea, blood loss and tenesmus.
2	Old M	Prostate Gleason 6 PSA 22	1.5, 1.5, 1.5, 1.5, 1.5, 1.4, 1.5, 1.5	119	162	Bloody diarrhoea continues, requiring transfusion. Rectal stenosis. (107 days)	
3	Old M	Prostate Ca No known metastases	1.5, 1.6, 1.6, 1.6	116	171	Weight loss (20 kg), diarrhoea, bowel stenoses.	Died on 20 May 2001, about 12 weeks after treatment. Autopsy: Coecal perforation, rectal stenosis.
4	Old M	Rectosigmoid Ca Prior breast Ca	1.0, 1.3, 0.9, 0.9	100	131	Few physical findings. No diarrhoea, rectal bleeding but haemorrhoids present. (125 days)	
5	Old F	Endometrium Stage IV	1.2, 1.3, 1.2, 1.2	94	127	Severe diarrhoea for months.	Died at home on 19 May 2001, about 10 weeks after treatment.

TABLE XII. (cont.)

Patient No.	Age ^a and sex	Tumour	Treatment times (min)	Dose to beam intersection point (Gy)	2 Gy Equiv. dose	Current symptoms ^a (days after last treatment)	Other findings
6 ^b	Middle aged F	Cervix IB	1.2, 1.3, 1.3, 1.3	92	122	Open abdominal wound from after radiotherapy. Mild rectal symptoms. (244 days)	Hysterectomy on 16 Jan. 2001.
7	Old F	Cervix IIB	1.0, 1.0, 1.5, 1.5	91	121	Severe diarrhoea after 13 fractions but continued treatment. Diarrhoea uncontrollable.	Died on 6 Mar. 2001, about 3 weeks after treatment.
8	Old M	Prostate Gleason 6 Stage unkown	1.2, 1.3, 0.8, 0.8	95	115	Now occasional diarrhoea. (135 days)	Early reactions during therapy.
9 ^b	Old F	Cervix IIIB	1.1, 1.0, 1.1, 1.0	88	111	Partial small bowel obstruction. Ulceration and necrosis of rectal mucosa. (226 days)	
10 ^b	Old F	Cervix IIB Prior breast Ca with chemotherapy	1.2, 1.2, 1.2, 1.2, 1.5, 1.2, 1.4, 1.4	85	115	Continued abdominal distension, ascites, liver and lung metastases.	Died on 28 Dec. 2000, about 13 weeks after treatment.

TABLE XII. (cont.)

Patient No.	Age ^a and sex	Tumour	Treatment times (min)	Dose to beam intersection point (Gy)	2 Gy Equiv. dose	Current symptoms ^a (days after last treatment)	Other findings
11	Middle aged F	Cervix IB	1.5, 1.4, 1.4, 1.5, 1.2, 1.3, 1.3, 1.3	81	108	Perineal pain, constant diarrhoea, dyurea. (230 days)	Currently hospitalized.
12 ^b	Middle aged F	Cervix IIB	1.1, 1.1, 1.1, 1.0, 0.4, 0.4, 0.8, 0.8	85	103	Anaemia, constant bloody diarrhoea. 15 kg weight loss. (233 days)	Dysuria. Operation of bowel stenosis.
13 ^b	Middle aged F	Endometrium Stage IV	1.1, 1.2, 0.8, 0.7	82	102	Recent onset of one episode of bloody diarrhoea. No other symptoms. (156 days)	
14 ^b	Middle aged F	Cervix IIA	1.5, 1.5, 1.2, 1.3, 1.5, 1.5, 1.5, 1.2	80	100	Diarrhoea since Jan. 2001. Colonic pain. (229 days)	
15 ^b	Old F	Endometrial Ca Stage IC	1.5, 1.3, 1.1, 1.1, 1.1, 1.2, 1.0, 1.1	79	99	Rectal bleeding, constipation, dysuria. (229 days)	

TABLE XII. (cont.)

Patient No.	Age ^a and sex	Tumour	Treatment times (min)	Dose to beam intersection point (Gy)	2 Gy Equiv. dose	Current symptoms ^a (days after last treatment)	Other findings
16 ^b	Middle aged F	Endometrial Ca Stage I	1.3, 1.3, 1.3, 0.9, 1.0, 1.5, 1.2, 1.0	77	94	Dysuria with frequency and low volume. Rectal mucous but no diarrhoea, lower abdominal pain. (234 days)	
17 ^b	Old M	Mullerian sarcoma	1.1, 1.1, 0.8, 0.7	79	98	Persistent bloody diarrhoea several times/day. Bladder and vaginal prolapse. (150 days)	Hysterectomy on 16 Nov. 2000.
18	Old M	Rectal adeno Ca	0.8, 0.9, 0.6, 0.7	81	93	Constant diarrhoea that requires diapers. (233 days)	One episode of bleeding.
19 ^b	Middle aged F	Vaginal Ca Stage II	1.0, 1.0, 0.9, 0.7	74	91	Bloody diarrhoea since October. Anaemia requiring transfusions. Urinary frequency. (229 days)	
20	Middle aged F	Cervix IB	1.4, 1.4, 1.7, 1.7	59	88		Several hospitalizations for enteritis and bloody diarrhoea. Died on 7 May 2001, about 13 weeks after treatment.

TABLE XII. (cont.)

Patient No.	Age ^a and sex	Tumour	Treatment times (min)	Dose to beam intersection point (Gy)	2 Gy Equiv. dose	Current symptoms ^a (days after last treatment)	Other findings
21	Middle aged F	Cervix IIB	1.0, 1.1, 1.1, 1.0	68	84	No clinical data.	Died (details unknown).
22	Old F	Cervix IIB	1.3, 1.3, 1.3, 1.3	61	83	Anaemia and constant diarrhoea after treatment.	Died on 28 Mar. 2001, about 7 weeks after treatment.
23	Old F	Endometrial Ca T2	1.3, 1.1, 0.8, 0.8, 1.3, 0.6, 1.3, 0.6	69	80	Bloody diarrhoea early, now subsided. Vomiting for last several months. Diabetic. (235 days)	
24	Old F	Endometrial Ca IIC	1.3, 1.6, 1.2, 1.2, 1.4, 1.0, 1.0, 1.4	58	73		Treatment terminated due to early reactions and diarrhoea. Died on 19 Oct. 2000, in hospital 2 weeks after treatment with anasarca and thrombocytopenia.
25 ^b	Middle aged F	Cervix IIB	0.8, 1.0, 0.8, 0.8	47	53	No symptoms now. (150 days)	Interrupted treatment for personal reasons. Received 18 treatments only.

TABLE XII. (cont.)

Patient No.	Age ^a and sex	Tumour	Treatment times (min)	Dose to beam intersection point (Gy)	2 Gy Equiv. dose	Current symptoms ^a (days after last treatment)	Other findings
26	Old M	Prostate Ca with rectal obstruction PSA > 700	1.2, 1.2, 1.7, 1.7	55	72	No diarrhoea or bleeding now. Rectosigmoid ulcer. (96 days)	Initial rectal bleeding and pain during therapy. Stopped treatment after 15 fractions.
27	Old M	Prostate Ca Gleason 5 PSA 12.5	1.0, 1.0, 1.2, 1.2	54	67	Occasional diarrhoea and bloating. Possible rectal colon mass. (86 days)	
28	Old M	Prostate Ca Gleason 5 PSA 9.5	1.1, 1.1, 0.8, 0.8	19	25	(179 days)	Patient had six fractions and completed his therapy at another hospital.

^a Physical examination performed: 27 May–1 June 2001.

^b Patient received brachytherapy treatment in addition to external beam treatment. The dose in this table refers to the external beam.

Note: Ca—cancer.

TABLE XIII. COMPARISON OF FINDINGS AT ONE YEAR IN SIMILARLY OVEREXPOSED PATIENTS IN THE SAN JOSE, COSTA RICA, ACCIDENTAL EXPOSURE

Patient ID	Field size (cm × cm)	2 Gy per fraction Equiv. dose	Findings
18	15 × 15		Massive colonic haemorrhage and perforation. Died before treatment finished.
44	10 × 10	70	Bloody diarrhoea, vaginal ulceration.
57	29 × 23	39	GI haemorrhage.
62	15 × 15	52	Rectal stenosis.
83	~15 × 15	77	Weight loss, continued rectal bleeding, use of diapers.
85	15 × 18	73	Perirectal ulceration, infection. some necrosis.
8	Several	59	Diarrhoea for three weeks which subsided.

7.7.1. Surviving patients

The medical team examined all 20 surviving patients. They provided advice and consultation to the treating physicians, patients and their families. The patients were examined by Drs Akashi, Cosset, Gourmelon, Mettler and Konchalovsky, who were working together. The prior findings, clinical charts and available imaging studies were also reviewed at the same time.

In addition to physical examination, the team also employed a grading system that has been suggested for the evaluation of long term effects (LENT). This system is useful in that it has detailed forms for various different tissues. This allowed a systematic and uniform assessment of the patients. A score can be derived for each patient but the usefulness of this score is not known at the present time.

The patients were initially assigned to one of five categories of expected consequences based upon clinical examinations alone, but this was later modified when the 2 Gy per fraction equivalent doses were calculated by team physicists. The classification is as follows:

- *** Severe or catastrophic effects due to overexposure from the accidental exposure.
- ** Marked effects due to overexposure from the accidental exposure and at high risk for future effects.

- * Radiation effects from the accidental exposure not severe at this time and at low risk for future effects.
- 0 No radiation effects at this time felt to be attributed to the accidental exposure. These patients may have radiation effects that would be expected from standard radiotherapy protocols.
 - Underexposure because radiotherapy was discontinued. At higher than normal risk for tumour recurrence.

Those patients who were in the first three categories (***, ** and *) had injuries related to the specific body part irradiated and the sensitive tissues in that area (Table XIV). There were two general categories of effects as follows:

- Lower gastrointestinal: chronic or bloody diarrhoea, bowel stenosis, stricture, fibrosis, obstruction, fistula, perforation.
- Bladder: dysuria, haematuria, contracture, incontinence.

Unfortunately, since the major radiation injury is likely to be confined to the rectum, rectosigmoid, ileum and bladder, external examination will tend to underestimate the true extent of the injuries. Figures 21, 22 and 23 show effects seen in patients Nos 9, 22 and 11, respectively. The team has reviewed the LENT-SOMA grading of these patients and the significant correlation of the calculated biologically effective dose is with the rectal and small bowel colon grades. There is no significant

TABLE XIV. DISTRIBUTION OF EXPECTED RADIATION CHANGES CAUSED BY NORMAL RADIOTHERAPY PROTOCOLS AND BY THE EXPOSURES IN THIS ACCIDENTAL EXPOSURE

Category of complications	Distribution for normal therapy	Distribution for the surviving Panama cases ^{a)}
*** Catastrophic	0	2
** Marked	1	7
* Increased	5	9
0 No changes expected	90	2
– Underexposed	4	0
Total	100%	20 cases

^a Physical examination performed: 27 May–1 June 2000.

correlation between bladder or skin changes and the doses delivered (2 Gy per fraction equivalent doses to the intersection point). This is not unexpected, given the fact that some patients received treatments of four or even eight fields and the dose to the skin and bladder may be lower than the dose to the intersection point of multiple beams.

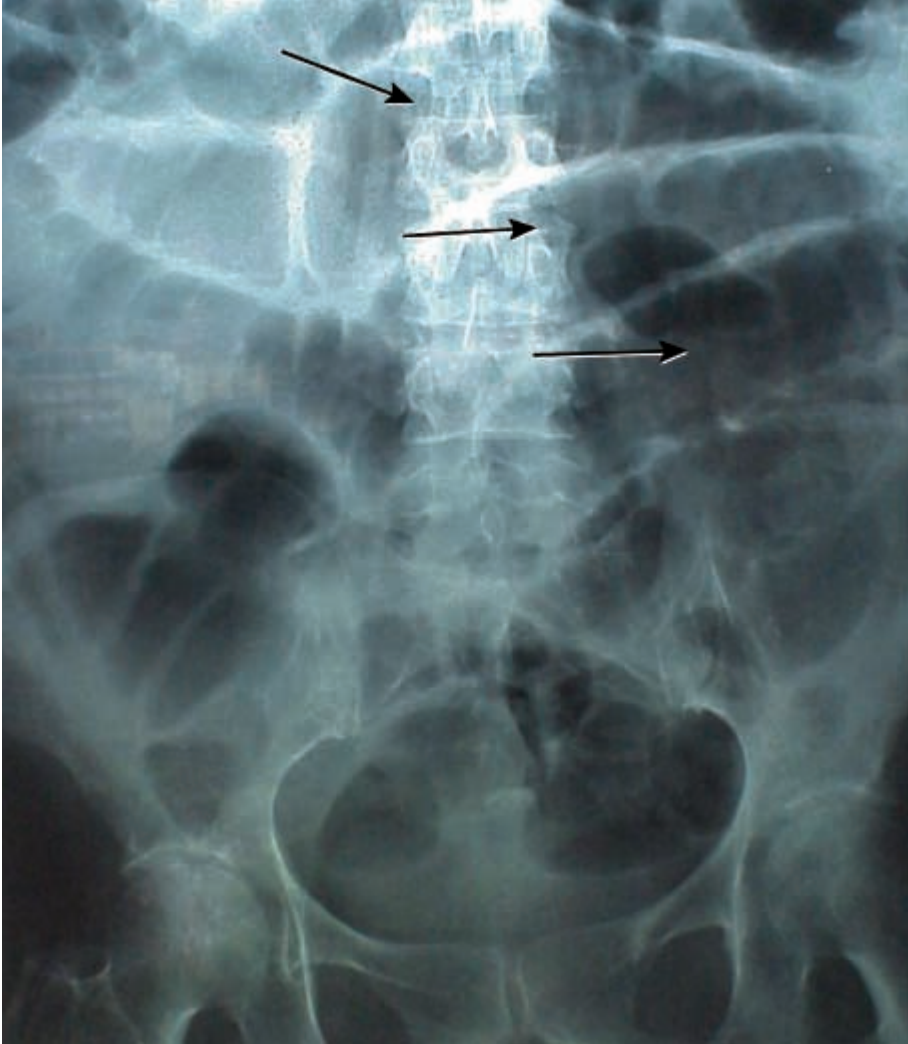

FIG. 21. X ray film of patient No. 9 showing dilated, air filled loops (arrows) of small bowel from a distal small bowel obstruction likely secondary to radiation induced stenosis.

7.7.2. Deceased Patients

Autopsy data were available for one of the eight patients who had died. Where autopsy data were not available, the clinical charts were reviewed to attempt to come to a conclusion about the possible role of radiation.

Patients who died were classified according to one of four categories as follows:

- Radiation exposure felt to be the major cause of death,
- Radiation overexposure possibly a significant contributor,
- Death due to causes other than radiation overexposure,
- Insufficient data at this time to make an informed judgement.

It should be pointed out that the team's assessment was related to the cause of death only. In the third category (not radiation related), there are some patients who

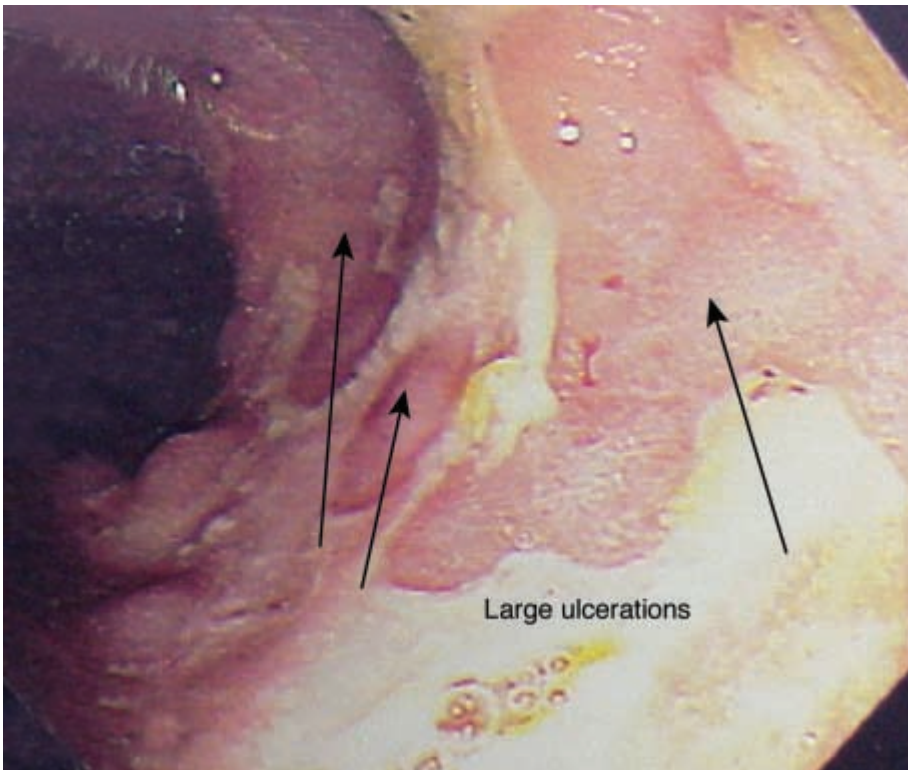

FIG. 22. Endoscopy of patient No. 22 showing ulcerations and destruction of mucosa (arrows).

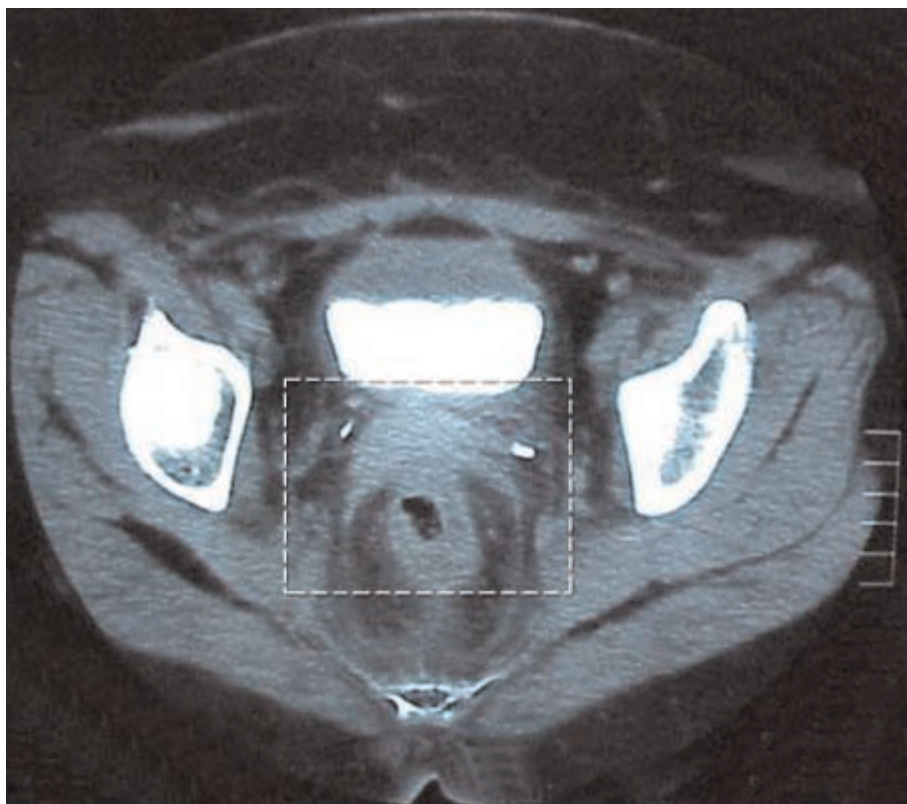

FIG. 23. Computer tomography image of patient No. 11 showing fibrotic tissue and stenosis of the rectum.

had overexposure and radiation injury, but in the opinion of the team this was not the cause of death.

The five patients for whom there were sufficient data to think that they died from radiation related injuries are in one general category:

- Lower gastrointestinal: colitis, haemorrhage, obstruction, fistula, perforation, peritonitis. An example is given in Figs 24 and 25.

The details of the eight deceased patients are presented in Table XV.

The effects seen in the patients who have either died as a result of irradiation, or who have had severe complications are consistent with what would be expected from the scientific literature. In almost all cases, both the total dose and the dose per fraction is higher than that known to cause the complications observed in these patients.

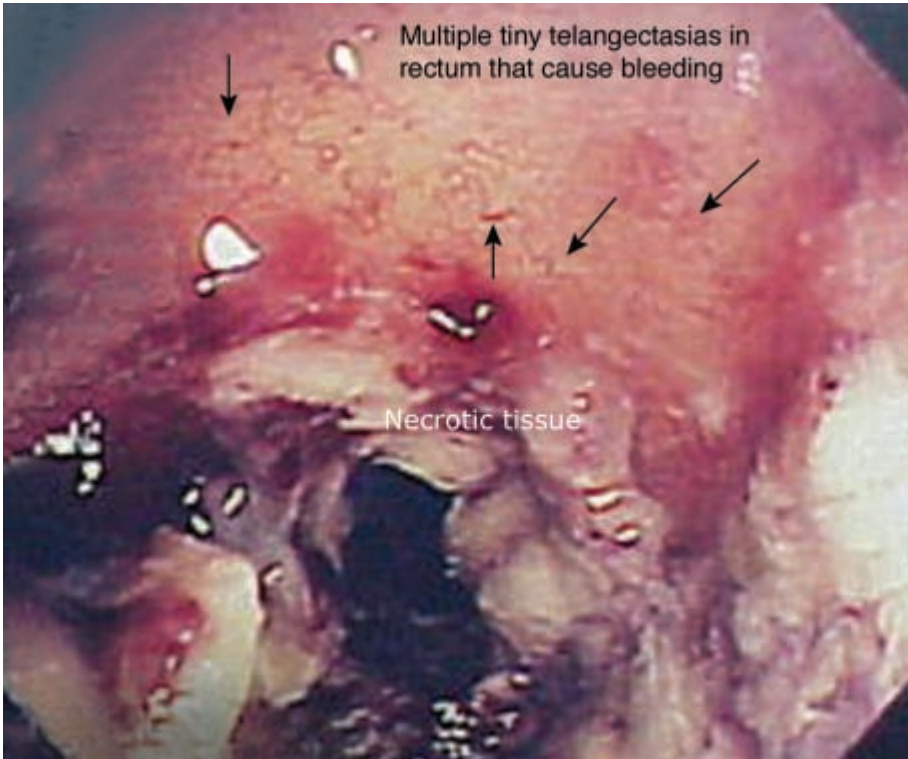

FIG. 24. Endoscopy of the colon of patient No. 3 showing necrosis and telangiectasias.

TABLE XV. DECEASED PATIENTS

Patient No. ^a	2 Gy per fraction Equiv. dose (Gy)	Radiation related death	Time of death (weeks after treatment)
3	140	Yes	12
20	82	Yes	13
22	79	Yes	7
5	119	Probably	10
7	115	Probably	3
21	80	Not enough data to allow a conclusion	Unknown
24	69	Not enough data to allow a conclusion	2
10	104	Death most likely related to cancer	13

^a Patient No. as in Table IX.

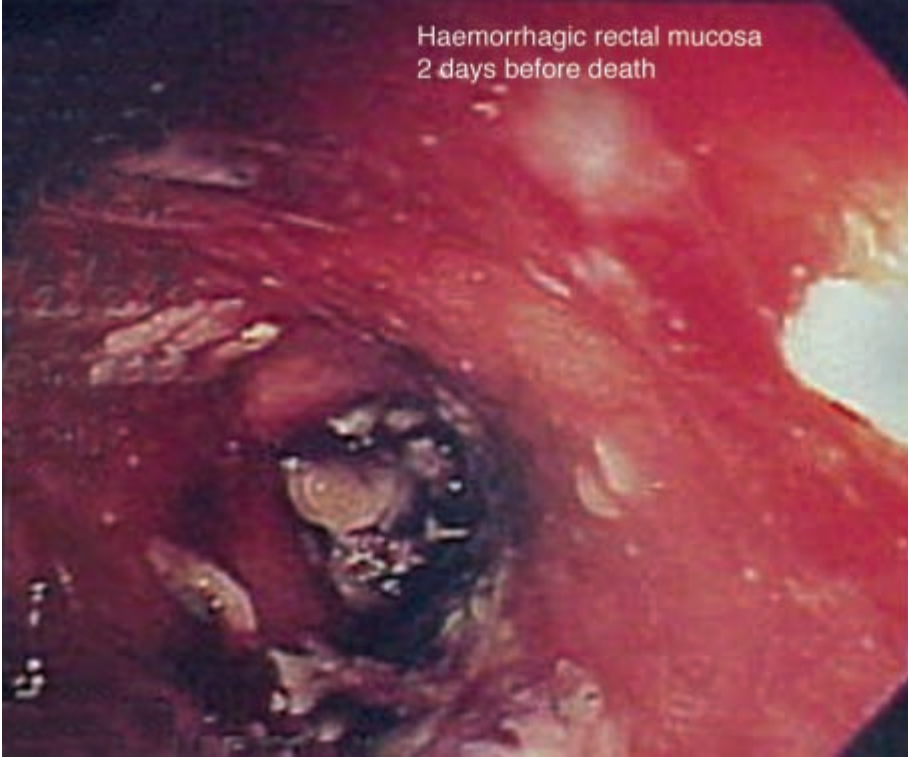

FIG. 25. Endoscopy of the colon of the same patient (No. 3) showing haemorrhage two days before death.

7.7.3. Sequence of events leading to death

It appears that there are two groups of patients who have had or will have different sequences of events leading to death.

The first group died very rapidly, only a few weeks after irradiation. From the necropsy findings and from the clinical charts, the most likely explanation seems to be that :

- Their bowel mucosa were largely or totally destroyed.
- As a consequence, the patients experienced severe (sometimes bloody) diarrhoea, leading to dehydration, malnutrition, hypoalbuminaemia, anaemia, and severe impairment of their general condition with loss of weight.
- Because of the disappearance of the mucosal barrier, bowel bacteria migrated to the blood, resulting in septicaemia and septic shock (likely to be fatal in patients in such an impaired clinical condition).

So, in this group the immediate cause of death is most likely to be septic shock, because of the particularly severe lesions of the digestive mucosa.

The second group of patients survived the initial critical period and are mostly still alive, but they have major intestinal and rectal problems. Development of the usual late effects of radiation, mainly stenosis and/or necrosis, is expected. Both of these can lead to death. One patient died from a perforation of the caecum, most probably linked to a localized necrosis. Stenosis would lead to bowel obstruction, with surgery being either impossible or very risky in such patients. Untreated bowel obstruction will lead to secondary perforation, septic shock and death.

8. FINDINGS AND CONCLUSIONS OF THE TEAM, AND LESSONS TO BE LEARNED

As is often the case with accidents, whether radiological in nature or otherwise, this accidental exposure would appear to have been caused by a combination of human and technical factors. The primary objectives of the follow-up investigation that is reported here are to ascertain the factors that contributed to the accidental exposure, to draw conclusions on the basis of the findings and to consider the lessons to be learned, with a view to preventing similar accidental exposures occurring elsewhere. A number of the lessons are not unique to this accidental exposure and indeed should be common knowledge, but these lessons are also presented as reminders. The specific findings from the accidental exposure and conclusions of the team are given in the following, together with general lessons to be learned and recommendations (in italics).

Some of the areas involved in dose prescription and dose delivery at the ION were subject to quality control checks, and these checks were found to be performed satisfactorily. They included calibration and quality control checks of the ^{60}Co treatment unit, and these have been in place and documented since 1999. Reports from previous expert missions, the results of the IAEA/WHO TLD postal dose quality audits and the results of measurements performed during this investigation have shown that the values of the relevant parameters were within the required tolerances and the performance of the treatment unit was satisfactory.

The data on the physics charts of the patients were regularly double-checked by two persons for the correct transfer of data, but the check did not include the computer calculated irradiation time. There was no quality control programme of the TPS nor written procedures, so changes in procedures for the use of the TPS were not subject to tests of their validity. The outputs of the TPS were implicitly assumed to be correct and not subject to verification by manual calculations.

The initiating event of this accidental exposure was an attempt to obtain a treatment plan, with isodose calculations, for fields involving more shielding blocks than the number for which the TPS had been designed. A method was found to digitize more than four blocks by entering the data into the TPS for multiple shielding blocks together as if they were a single block. The output from the TPS using the new method of data entry was not verified and was not compared with the output produced using the previous method. In addition, several characteristics of the TPS made it easier for the error to occur:

- It is questionable whether the information in the instructions was sufficiently clear to guide the user in detail on the manner in which the blocks should be digitized.
- Several different methods of digitizing blocks were accepted by the computer.
- There was no warning on the computer screen when blocks were digitized in a manner different from the one described in the instructions.
- When several blocks were digitized together as if they were a single block describing two loops, the TPS produced a diagram which was the same as that produced when data were entered correctly, thereby giving the impression that the results were correct.

This method of digitizing the block data was used for a number of patients without any recognition of the longer than necessary times of exposure. Although some symptoms of excessive exposure were noted, they were not effectively investigated, with the consequence that the accidental exposure went unnoticed for a further number of months.

8.1. OPERATING ORGANIZATION: RADIOTHERAPY DEPARTMENTS

8.1.1. Quality assurance and radiotherapy

A single error in the method of entering data into the TPS led to the delivery of wrong doses to patients and to severe, and in some cases fatal, consequences. In radiotherapy, a single error can be fatal if it goes unnoticed. An efficient system for detecting and correcting errors therefore needs to be in place: this implies a QA programme with sufficient double and independent checks.

A comprehensive QA programme needs to be in place in any radiotherapy facility. In addition to the staff involved in the implementation of the programme, all hospital managers and administrators need to be made aware of this and of the consequences of not having it, as part of their training.

A committee should be set up to exercise oversight of the QA programme. This committee should consider the completeness of the QA programme, the validity of existing and revised procedures and the results of quality control checks. The typical composition of such a committee is: a radiation oncologist, a medical physicist, a radiotherapy technologist and an administrator representing the management of the hospital. The BSS place a strong emphasis on QA in radiotherapy.

8.1.2. Treatment planning systems as a safety issue

The accidental exposures involved the use of a computerized TPS. External audits and the team mission confirmed that quality control protocols were properly implemented for the ⁶⁰Co treatment units and that calibration was satisfactory, but no such protocols were in place for the computerized TPS.

Computerized TPSs for radiotherapy are to be regarded as safety related devices, for which a safety assessment and quality and safety measures are as important as they are for cobalt units and accelerators. The TPS needs to be included in the QA programme.

8.1.3. Manual calculation check of the computer calculated plan

The staff performed double checks of the data transfer from the prescription and computer output into the patients' treatment charts, but these checks did not include the treatment time calculated by the computer. It was implicitly assumed that the computer output was correct.

Results provided by the TPS need to be checked, and this should include verification by manual calculation of the treatment time and dose to the selected point. This verification should be part of the QA programme.

8.1.4. Changes in procedures

The method of entering the co-ordinates of shielding blocks into the TPS when calculating dose distributions and irradiation times for particular treatments was changed without subsequent testing. This led to incorrect results. Written procedures requiring approval, testing and documentation of any changes before they are adopted were not available at the ION.

Every step in the radiotherapy process should be reflected in the written procedures. New procedures or changes in procedures should require formal testing, approval and documentation, as part of the QA programme.

8.1.5. Workload and team integration

The calculated treatment times for the affected patients were substantially longer than those for other patients with similar treatments. Although this was abnormal, the professionals involved were not aware of it.

Individual and team awareness of the treatment arrangements for each patient are essential to ensure that abnormal situations are noticed quickly. The members of the team will normally be the radiation oncologist, the medical physicist and the radiotherapy technologist in charge of a particular patient. This team would be expected to meet for a “new patient planning conference” [21], as well as during the simulation of the treatment and when the patient is first set up for treatment. These occasions provide opportunities to discuss the details of the treatment and to come to a common understanding of them, and they therefore present opportunities for detecting any abnormal features or unusual values of parameters in the treatment plan.

The level of individual and team awareness may have been inadequate at the ION. The division of the team between two hospitals and the limited presence of some professionals may have contributed to some degree of fragmentation. This was made worse by the heavy workload involving some 70–80 patients being treated per day, many of them during the evenings with only a technologist present.

Pressure due to a heavy workload, if not properly managed, can result in a reduction of quality and safety. It can cause the staff to perform in a more mechanical manner, reducing awareness and allowing indicators of abnormal situations to be overlooked. Errors may ‘fall between the cracks’ instead of being picked up.

The workload should not result in a lowering of quality and safety standards. Staff should conform to the guidance provided by standards of good practice (usually given by professional bodies) and their work should be kept under review and reexamined with regard to the workload (number of patients) and to any issue that places an extra burden on them, such as the introduction of a new technique.

An integrated team approach to radiotherapy, combined with well defined individual functions and responsibilities, should be part of the design and implementation of a radiotherapy department.

8.1.6. Observation of unusual reactions of patients

Patients affected by the excessive dose showed unusual reactions, which were more severe than those expected from the prescribed doses. The first review did not reveal the cause of the problem, and treatment of the patients continued or was resumed.

Careful and frequent patient observation, followed up by comprehensive investigation of the possible causes of unexpected symptoms, are indispensable for

the early discovery of errors and the mitigation of their consequences. Observations of unexpected symptoms should be prompt and should include manual recalculations and dose measurements on a phantom.

8.1.7. In vivo dosimetry

Errors in dose delivery can be detected by in vivo dosimetry, by the use of solid state detectors placed on the patients. This provides evidence that the correct dose has been delivered to a patient, and is therefore an additional level of defence in depth.

Implementation of in vivo dosimetry requires the allocation of resources in terms of equipment, calibration of detectors, quality assurance and, most important, adequate training. These requirements are difficult to meet in some countries. Nevertheless, with appropriate planning and allocation of resources, in vivo dosimetry can be implemented even in small radiotherapy departments [22], and this is a desirable feature.

In vivo dosimetry should be promoted as far as practicable in radiotherapy departments, but proper preparation for such a programme is necessary.

8.1.8. Local advice from the manufacturer/supplier

The users of the TPS were looking for a solution to an unusual request from the treating oncologist in the use of the TPS. The co-operation and advice of the manufacturer/supplier in fulfilling this request was not sought.

For proper use of equipment, co-operation between the user and the supplier is essential, and this co-operation should be established from the time of purchase of the equipment. In addition, procedures not included in the manufacturer's instructions should only be attempted in consultation with the manufacturer/supplier.

8.2. NATIONAL AUTHORITIES

8.2.1. Quality assurance

The regulations in Panama require a QA programme to be implemented for the clinical and physical parameters of radiotherapy. There was some quality control at the hospital, but it was incomplete. It covered calibration and quality control of the irradiation unit, and was associated with adequate equipment calibration and performance. The error that caused this accidental exposure was in an area which was not addressed by the quality control that was in place.

Inspections by the regulatory authority, and the external audit (in 1999), had been carried out before the accidental exposure. The recommendations resulted in

better radiation protection and safety procedures within the department and documented calibration and quality control of the radiotherapy equipment. Unfortunately, procedures for the TPS were not developed.

A QA programme for radiotherapy should be a mandatory requirement in the regulations, and the requirement should be enforced (as was the case in Panama). The protocols used should be in accordance with well proven programmes developed either at the national or regional level.

National authorities should promote external audits; recommendations arising from the audits should be evaluated by a QA and radiation protection committee and implementation should be closely followed up.

8.2.2. Communication between regulators and users of radiation

The records at the regulatory authority indicate that the ION was repeatedly requested to provide information on the QA procedures. Although the quality control protocols of IAEA-TECDOC-1151 [6] had been used for some time for calibration and quality control of the ^{60}Co unit, the ION does not seem to have responded to the requests of the regulatory authority for information.

Users of radiation should understand that they share a common objective with the regulatory authority, which is safe operation, and that the purpose of monitoring compliance with the regulatory requirements is oriented to that objective.

8.3. EQUIPMENT MANUFACTURERS AND SUPPLIERS

8.3.1. Software in treatment planning

In the TPS involved in this event, the manual of instructions does not describe precisely how to digitize co-ordinates of shielding blocks and there are not enough relevant illustrations. In addition, it does not provide specific warning against data entry approaches that are different from the one described. The indication on this matter is vague, other than a general disclaimer at the beginning of the manual.

Instructions and explanations which do not make clear exactly what is and what is not allowed leave open the possibility of users choosing an approach that was not tested by the manufacturer.

Software should be tested to ensure that it is as foolproof as possible. The instructions should guide the user explicitly and fully through the process, following options that are allowed and have been tested, so as to prevent users from trying another method that may not have been tested by the manufacturer. Deviation from the steps given in the instructions should be prevented by a warning inserted both in the instructions and on the computer screen display.

8.4. THE MEDICAL COMMUNITY

8.4.1. Findings

The accidental exposures at the ION in Panama were very serious. Many patients have suffered severe radiation effects due to excessive dose. Both morbidity and mortality have increased significantly. This series of accidental exposures is unique. Previous radiation therapy accidental exposures that resulted in mortality had involved excessive doses of 30–50% more than prescribed. There are no reported previous accidental exposures in which the doses delivered were 50–100% above prescribed radiotherapy doses, with all affected patients being treated in the pelvic region.

Not all of the radiation effects observed in these patients can be attributed to the accidental dose. A few of the patients who received treatment at the time of the accidental dose have radiation effects typical of those that would be expected from the prescribed doses. Some patients have pains or disorders that cannot be attributed to radiation. However, although some damage to normal tissue is expected as a result of standard radiotherapy protocols, the incidence of serious and obvious radiation effects caused by this accidental exposure was much higher than would be expected from the prescribed doses.

Additional radiation effects will become apparent over the next months and years, and given the radiation doses received, the morbidity and mortality can be expected to increase. Most of the surviving patients already have serious medical problems related mainly to bowel and bladder overexposure. Most of the untoward bowel and bladder effects cannot be remedied.

8.4.2. Recommendation on patient care and follow-up

The following recommendations applicable to this case are also generally applicable to other accidental exposures of radiotherapy patients.

In association with the evaluation of the event leading to the accidental exposure:

- A clinical–pathological conference should be held between the medical examiner and the clinicians that continue to care for the surviving patients.
- Given the internal nature of the injuries, examinations that allow inspection of internal organs, such as endoscopy, should be carried out.

Patients should be made aware of the facts that:

- Appropriate nutrition is extremely important. They should be informed and helped in obtaining a low residue, high protein, high calorie and iron rich diet. In some cases, hyperalimentation may be necessary.

- Psychological support may provide significant benefits.

The medical follow-up of the patients should take into consideration that:

- Medical care and surveillance should continue to be provided for the surviving patients. The approach should be interdisciplinary.
- Home care (rather than hospital care) programmes should be favoured whenever possible.
- Medical care should be supportive and conservative.
- Surgery of highly radiation exposed tissue is very risky and should only be performed on extremely strong indications.
- An autopsy is strongly recommended when, unfortunately, a patient dies.

Annex I

TERMINATION REPORT TO THE CONTACT POINTS RADIOLOGICAL EMERGENCY IN PANAMA

Termination Report to the Contact Points Identified under the Convention on Early Notification of a Nuclear Accident and the Convention on Assistance in the Case of a Nuclear Accident or Radiological Emergency

On 22 May 2001, the IAEA informed Contact Points identified under the Convention on Early Notification of a Nuclear Accident and the Convention on Assistance in the Case of a Nuclear Accident or Radiological Emergency (the Assistance Convention) of a radiological emergency at a radiotherapy facility in the National Oncology Institute in Panama affecting 28 patients undergoing radiotherapy. On 2 June 2001, the Contact Points were provided with additional advisory information, which informed them of the preliminary conclusions of an expert team that had been sent by the IAEA to assist the Panamanian Government under the auspices of the Assistance Convention.

The purpose of this advisory information is to inform Contact Points that the IAEA team has completed its mission and confirmed the preliminary conclusions included in the advisory information provided on 2 June 2001, and to provide some additional details of this emergency.

The experts found that the radiotherapy equipment had been working properly and had been adequately calibrated. The experts confirmed that the cause of the emergency lay with the entering of data into the computerized treatment planning system which is used at the Institute in question. Shielding blocks are used to protect healthy tissue of patients undergoing radiotherapy at the Institute, as is the normal practice. Data on the shielding blocks are entered into the computer, which calculates the dose distributions in patients and the treatment times.

Until August 2000, the practice had been to enter data in one batch for each shielding block. The treatment planning system has a limitation on the number of shielding blocks for which data can be entered in this way. It was reported that the practice at the facility was changed from August 2000 in order to overcome this limitation for some treatments that require more shielding blocks. For the 28 patients who were affected, data were entered in a batch for several shielding blocks at once. However, this approach apparently caused the treatment planning system to calculate incorrect radiation doses and, consequently, incorrect treatment times.

The team found that it was possible to enter data in one batch for several shielding blocks in different ways; and that for some ways of entering the data, which were accepted by the treatment planning system, the output values were calculated incorrectly. However, whichever way was used, the computer produced a printout

drawing that showed the treatment field and the shielding blocks as if the data had been entered correctly. The isodose curves for a single treatment field are somewhat different, but for multiple treatment fields the differences are not so obvious. (It should be noted that, for irradiation treatments in the pelvic region, which was the region of treatment for all the patients concerned, multiple treatment fields are always used in the Institute¹.) These factors, together with an apparent omission of manual checking of computer calculations, resulted in the patients concerned being exposed at radiation levels that were set too high.

The IAEA team was informed that, of the 28 patients concerned, eight have since died; and the team confirmed that five of these deaths are probably attributable to the patients' overexposure to radiation. Of the other three deaths, one is considered to have been related to the patient's cancer; while there was insufficient information available to draw conclusions in respect of the other two deaths. Of the surviving 20 patients, most injuries are related to the bowel, with a number of patients suffering persistent bloody diarrhoea, necrosis (tissue death), ulceration and anaemia. About three-quarters of the surviving 20 patients may be expected to develop serious complications, which in some cases may ultimately prove fatal.

The IAEA team provided the Government of Panama with a briefing on the findings and conclusions of the mission, which were consistent with those of the local group of investigators. The Government has agreed that the findings and conclusions identified be shared on an urgent basis with the international community in order to help prevent other overexposures where such an approach for treatment may be in use.

The Contact Points are requested to draw these findings and conclusions urgently to the attention of the relevant national authorities, who are encouraged to urge users to check that any relevant systems are being operated in accordance with an appropriate quality assurance programme. It is reiterated that particular emphasis should be given to the need to follow written quality assurance procedures, which include:

- ensuring that the procedures require manual checks of the doses to the prescription points as calculated by computer, for each individual patient, before the first treatment; and
- Performing verification measurements using a phantom in exceptional cases of complicated treatments, for which manual calculations may not be practicable.

The IAEA plans to publish a detailed report on the circumstances of this emergency and the lessons to be learned as soon as feasible.

¹ 'Treatment field' is the term used in radiotherapy to denote the direction of the beam and the size and shape of its cross-section. Treatments in the pelvic region often require multiple treatment fields (that is, irradiation from different directions).

Annex II

LITERATURE REVIEW OF RADIATION EFFECTS IN PERTINENT TISSUES IN THIS ACCIDENTAL EXPOSURE

Extensive discussions of radiation effects on specific tissues can be found in several textbooks [19, 23, 24].

SKIN

Changes of the skin that have been described in radiation therapy usually involve a course totalling 40–50 Gy from an orthovoltage source in 20–25 equal fractions over a four to five week time period. In such circumstances, patients may demonstrate a faint erythema due to capillary dilatation during the first week of treatment. Some epilation is noted at 10–14 days. The true erythema usually occurs in the third week of treatment, with the skin becoming red, warm and edematous. Moist desquamation begins at the fourth week with oozing of serum.

In radiotherapeutic situations, desquamation is usually healed by the time treatment is ended because there is compensatory regeneration in the basal layer of the skin. This regenerative capacity usually exceeds the destructive capacity during conventional radiotherapy. Dry desquamation occurs if irradiation is halted during the third week at the 30 Gy level. In these circumstances, the skin may itch, and scaling and increased pigmentation may occur. The erythematous changes and desquamation are almost always confined to the treatment field, although occasionally they may extend beyond it. In addition, a generalized skin reaction may occur, perhaps due to the indirect effect of a circulating product resulting from the breakdown of tissue as a result of radiation. If doses exceed those discussed, necrosis of the structures underlying the epidermis may occur.

Skin ulceration may occur very early with high absorbed doses. These ulcers may heal but ultimately will recur. With more conventional doses such as those used in radiotherapy, painful, slowly healing ulcers may occur and persist for years. The probable cause of these late ulcers is ischaemia due to the arteriolar and small artery changes mentioned earlier.

With relatively large doses of radiation such as a single dose of 20–40 Gy or more, a bullous type, moist desquamation may occur in four weeks. In this situation, small blisters tend to coalesce and rupture. If the dose is high enough, blisters may be formed from beneath the basal cell layer. At this stage, the clinical lesion may appear very similar to a second or third degree thermal burn, but an important differential diagnostic point is that the patient will not remember having been burned. In such

circumstances, the bullae may become infected, and there also may be sloughing of the epidermis. A week or two after sloughing of the epidermis, the affected areas may become covered with epidermis, although ulcers tend to recur with later arteriolar obliterative changes. In patients who have developed late radiation ulcers following fractionated radiotherapy with doses of 40–120 Gy, there is a reduction in circulation that can be measured by radionuclide techniques. Venous and lymphatic vessel occlusion with swelling of an extremity have also been reported.

With radiotherapy, temporary loss of hair (epilation) occurs in about three weeks with 3–5 Gy; hair begins to return during the second month and this continues for up to one year. Single doses of 7 Gy may cause permanent epilation, with the latent period being less than three weeks. Not all body areas have the same radiation epilation sensitivity. The scalp and beard are most sensitive, with the chest wall, axillary, abdominal, eyebrow, eyelash, and pubic hair being less sensitive, in that order. The hair follicles of children are more sensitive than those of adults. Hair that has regrown is always finer and slower growing than the original hair. It may also be of a different colour.

Skin tolerance to radiation depends significantly on the volume of tissue irradiated. As the volume of skin irradiated becomes smaller, the dose required to produce necrosis increases. For example, the skin tolerance dose (TD) for a circular field of 150 cm² is approximately 15 Gy in a single dose, whereas for a circular field of 50 cm² the TD is almost 20 Gy. For radiotherapy situations the skin tolerance dose is about 50 Gy for a skin area of 100 cm², 58 Gy for 16 cm², 84 Gy for 4 cm² and 392 Gy for 1 cm². Occasionally, there are rare atypical skin reactions after radiotherapy that resemble erythema multiforme, pemphigus and other entities. Such reactions can begin in the irradiated area but then become more generalized. Chemotherapeutic agents may also play a role in the occurrence of such reactions. Radiation therapy also can exacerbate existing conditions such as psoriasis.

SMALL INTESTINE

The small bowel demonstrates mucosal reactions in radiotherapy schemes in which 30–40 Gy are given over four weeks. Higher doses may cause obstruction and other complications. Prior surgery, with formation of adhesions, reduces the tolerance of the bowel to radiotherapy. The small intestine is quite sensitive to radiation injury because of the rapidly proliferating cells of the mucosal epithelium in the crypts of Lieberkuhn. These columnar cells, which divide approximately once every 24 h, push the more mature cells up the villi to the intestinal lumen, where they mature to their final state when they reach the tips of the villi. The epithelium of the crypt is replaced in fewer than seven days, making this the most rapidly proliferating tissue and one of the most radiosensitive tissues in the body. The relatively high sensitivity of the

mucosal lining compared with underlying vascular and stromal components means that acute changes are of the most clinical significance and that late changes due to arteriolar narrowing rarely occur. The radiosensitivity of the small intestine is clearly affected by the intestine's ability to move. Because the terminal ileum, the duodenum and the most proximal portion of the jejunum are relatively fixed, these areas are the most frequently involved in complications of radiation injury.

Because the small intestine was relatively inaccessible until the advent of endoscopy, there exists little in the way of human observations. A single case of accidental exposure has, however, been reported. Within seven days after single doses in excess of 15 Gy, superficial erosion, pyknosis and sloughing of the epithelium into the lumen occur. At somewhat lower doses, mucosal regeneration begins by seven days. In therapeutic situations, within 12–24 h after daily doses of 1.5–3 Gy, cell necrosis in the walls of the crypts can be identified. There is progressive loss of cells, as well as atrophy of the villi. During the period of mucosal sloughing, patients experience nausea, vomiting, cramping, pain, diarrhoea, fluid and electrolyte imbalance, and sepsis. Hypoproteinemia due to protein leakage through the damaged mucosal cells may occur.

The pathophysiology of radiation enteritis is poorly understood, and increased prostaglandin levels have been implicated; however, Lifshitz et al. [25] have examined patients receiving radiotherapy and have found no increase in prostaglandin levels. Other investigators have concluded that lactose malabsorption is a factor in the nausea, diarrhoea and vomiting experienced by patients undergoing pelvic radiotherapy. Henriksson et al. [26] have pointed out that sucralfate (an aluminium hydroxide complex of sulfated sucrose) can protect against radiation induced diarrhoea and bowel discomfort in patients receiving bowel radiotherapy. A gastrointestinal radiographic contrast examination of the patient during the acute clinical period generally demonstrates a rapid transit time of barium from the stomach to the colon. Hypermotility is demonstrated in just under one half of the patients receiving radiation therapy to the small bowel. Lentz et al. [27] have reported that after whole-abdomen radiation therapy in the range of 29 to 51 Gy for gynaecological malignancies, a transient chylous ascites developed in about 3% of patients.

During the chronic period, delayed effects are generally manifested as intermittent abdominal pain or obstruction. The diagnosis is difficult to make without the history of radiation exposure. Additional symptoms include occasional bleeding, diarrhoea, cramping, abdominal bloating, nausea, vomiting and laboratory findings of hypoproteinemia and malabsorption. Perkins et al. [28] have published a radiological–pathological correlative study of nine patients with radiation injury of the small bowel. In general, barium studies demonstrate a lack of distensibility of a bowel segment without sharp margins and the persistence of edematous appearing mucosa with a 'saw-toothed' appearance. Donaldson et al. [29] have reviewed the late complications in children after whole-abdominal radiation therapy for Wilms'

tumour, teratoma or lymphoma. Of 14 long term survivors, five developed severe radiation injury, with small bowel obstruction, within two months of therapy completion. The average age at treatment was six years, and the treatment was 31 Gy in 7–20 fractions over 11–39 days. Coia and Hanks [30] reviewed the complications in 1026 patients treated with large field infradiaphragmatic radiation therapy for Hodgkin's disease and seminoma. The most frequent complications were gastrointestinal injury such as peptic ulceration, haemorrhage, chronic diarrhoea and intestinal obstruction. The bowel complications occurred in 1% of patients at doses of less than 35 Gy and 3% of patients for doses equal to or greater than 35 Gy. Histologically, during the subacute and chronic period, the villae of the mucosa are often blunt and thickened, and the mucosal cells are often flattened. The lamina propria may be normal or may demonstrate severe fibrosis. Telangiectasia may occasionally occur as well. Overall, collagen deposition throughout the submucosa is demonstrated most consistently. The arterioles, as in other tissues, show endothelial proliferation and intimal fibrosis.

COLON, SIGMOID AND RECTUM

The mucosal cells of the colon have a somewhat longer turnover time (4–8 days) than those of the small intestine. There are also fewer epithelial cells at risk for a given surface area, and some of the cells remain in prolonged interphase. Thus, the epithelial portions of most of the colon have somewhat less radiosensitivity than the small intestine and about the same radiosensitivity as the oesophagus. The blood vessels and underlying muscle have a radiosensitivity similar to that of the remainder of the gastrointestinal tract.

The pathological basis of radiation induced changes in the colon and rectum is similar to that already discussed for the small intestine. Acute changes are easily demonstrated during a course of radiation therapy in which the total dose exceeds 30–40 Gy. These changes include hyperemic mucosa and abnormalities in mucus production. Pathologically, the peritoneal surfaces are roughened, with variable amounts of fibrin or fibrous plaques, and shallow mucosal ulcers may be present. When superficial ulcers appear, the changes are usually relatively well healed within a month. Treatment usually consists of low residue diets and symptomatic management of diarrhoea.

Six to 12 months after radiation therapy, the patient may exhibit painless rectal bleeding. In mild stages, the rectal changes consist of mucosal thickening and exudate; however, there may ultimately be progression to ulceration, rectal strictures or fistulas. The mucous membrane is usually granular, and the ulcers may be either solitary or multiple, usually 1–4 cm in diameter, and are located in a transverse

direction. The appearance on barium enema in these circumstances may be confused with that of a recurrent tumour.

The best method for determining radiation proctitis is by endoscopy. Gehrig et al. [31] have indicated that after fractionated radiotherapy, the incidence of proctitis one to six years later is 0% at 40 Gy, 20% at 60 Gy and 50% at 90 Gy. The most characteristic findings described by other authors are arteriolar narrowing, telangiectasia and diminished distensibility. Some relief of radiation proctosigmoiditis can be achieved through the use of rectal steroids or sucralfate. The occurrence of fistulas, perforation and small bowel injury can lead to mortalities in the range of 25%.

Chronic changes consist of shortening and fibrosis of the colon, with occasional areas of tapered stenosis. At this stage, the mucosa may be normal or atrophic. Occasionally, mucosal glands are present deep in the muscle, probably as a result of healing ulcers. The strictures generally result from extensive submucosal fibrosis. The radiological diagnosis may be suggested by an hourglass type deformity on barium enema or a 'lead pipe' appearance, such as is seen with long standing ulcerative colitis. Treatment of these stenotic areas usually is symptomatic. Dilation is sometimes utilized, although occasionally surgical intervention is necessary. The pathology of the late changes is a result of progressive endarteritis and subsequent fibrosis. In general, the fixed position of the rectosigmoid portion of the colon causes it to be relatively susceptible to radiation injury when compared with the transverse colon.

The rectum is relatively resistant to radiation, although loss of the epithelium occurs on a transient basis with doses of 30–40 Gy. Chau [32] has reported the incidence of bowel complications in supervoltage pelvic irradiation to a total dose of 60 Gy to be between 1 and 3%. As can be expected, the incidence of acute changes increases dramatically with an increase in the volume of tissue irradiated. Daily doses to the entire abdomen in excess of 1 Gy are usually poorly tolerated.

In terms of the importance of biological factors, increased age, race and previous surgery are thought to be associated with a greater number of complications. The anatomic vascular distribution may be of some importance, although it has been demonstrated that intestinal ulcerations do not always occur at the area of maximal irradiation or least vascularity, but appear to result more often from combined injury, mechanical trauma and bacterial action.

BLADDER

The bladder is relatively more radioresistant than the kidneys, with the most resistant portion of the genito-urinary system being the ureters. Changes in the ureters

and bladder were identified as early as 1930 by Schmitz [33], who reported the first case of ureteral stricture. Other historical aspects have been well discussed and described by Rubin and Casarett [19]. Bladder injury, as well as distal ureteral problems, became apparent with the wide clinical experience gained through treatment of cervical carcinoma and other pelvic malignancies, particularly with radium therapy. The epithelium of the bladder and ureters is composed of proliferating vegetative intermitotic cells in the deep layer of the epithelium. These germinal cells are analogous to the same cells in the epidermis. Thus, the effects described for skin and mucosa are generally applicable to the mucosa of the urinary bladder.

Acute cystitis may occur four to six weeks after a course of radiotherapy. Symptoms include dysuria, nocturia and frequency. Hyperemia and oedema of the mucosa may be seen. At high doses, partial desquamation occurs. In severe cystitis with accompanying infection, ureteritis and transient hydro-ureter may be identified. The treatment of radiation cystitis is similar to that of cystitis due to other causes.

In a series of 527 patients studied after therapy for cervical cancer, Montana et al. [34] indicated that the risk of cystitis was 3% for those with a bladder dose of less than 50 Gy and 12% for those receiving fractionated doses in the range of 80 Gy or more to the bladder.

In the subacute clinical period (six months to two years after therapy), painless haematuria may be a sign of a trigonal ulcer. Cystoscopically, there is telangiectasia of the vessels in the region of the trigone; if obliteration of the smaller arterioles occurs as well, ulceration and fistula formation may result. The bladder can usually tolerate 55–60 Gy in 20 fractions over four weeks. Higher doses may be delivered with radium implants, and the changes observed include erythema, fibrosis, ulceration and fistula formation. If the distal ureters are involved, strictures and hydronephrosis may result. Goodman and Dalton [35] indicate that pelvic inflammatory disease, urinary tract infection and surgical manipulation increase the likelihood of ureteral stenosis. In general doses exceeding 50–60 Gy over a five week therapeutic regimen or 20–25 Gy in a single application carry a relatively high risk of late radiation reactions. With radium application for cervical carcinoma, the dose to the bladder is usually in the range of 50–60 Gy, and rarely above 70 Gy.

Parliament et al. [36] have reported that about 3% (10 of 328) of patients treated with curative intent for cervical carcinoma developed obstructive uropathy. Eight cases were unilateral, and the median time to obstruction was 26 months. Of course, recurrent cervical carcinoma is a much more common cause of obstruction. Behr et al. [37] report a higher incidence (12%) of hydronephrosis and a very high incidence of incontinence, probably due to fibrotic changes of the bladder and urethra.

In males treated for prostatic carcinoma, the incidence of incontinence is sometimes reported to be as high as 18% after radiotherapy, while other authors suggest that it is mostly related to surgery. A very large study by Lawton et al. [38]

reported on 1020 patients followed for at least seven years after external beam radiotherapy for prostate cancer. Only a total dose greater than 70 Gy was found to have a significant impact on the incidence of urinary complications. The total incidence of complications was: cystitis 2.6%, haematuria 3.1%, urethral stricture 4.6%, and bladder contracture 0.7%.

One case report presents retroperitoneal fibrosis causing ureteral obstruction 13 years after 30 Gy of external beam radiotherapy for stage I testicular carcinoma. Since there are quite a number of causes of retroperitoneal fibrosis and there are not more reports following radiotherapy suggest that the fibrosis may not be radiation related.

In the chronic stages, the bladder may become contracted, thick and indurated. There may be multiple areas of ulceration, oedema, and telangiectasia. Collagen may replace muscular tissue, and breakdown of the bladder wall may occur. There also is submucosal fibrosis, which is equally prominent in early and late stages. Patients with bladder cancer who have had a cystectomy and a urinary diversion to an ileal loop have a high risk of complications following radiotherapy doses of 55 Gy in 20 fractions over four weeks.

UTERUS

The relative radioresistance of the uterus compared with other structures has been demonstrated by its ability to withstand being utilized as a cavity for placement of radium during radiotherapy. Rubin and Casarett [19] have termed the radiation tolerance of the uterus “amazing”. It is not known what doses are required to cause sterility on the basis of uterine irradiation because most of the therapeutic methods employed have also involved ovarian ablation. Doll and Smith [39] reported a study of 1068 women who were treated for metropathia haemorrhagica. At dose levels ranging from 6.25 to 10.5 Gy, 97% had induced menopause. It has also been reported in other studies that doses of 1.5–2.25 Gy in three doses over three weeks decreased menstrual periods in 75% of patients; however, over one half became pregnant later. Applications of radium in the region of the uterine cervix can result in doses to the cervix of 100–200 Gy. Hamberger et al. [40] have analysed the dose schedules causing severe complications for treatment of carcinoma of the cervix. Standard radiotherapy doses for endometrial carcinoma used in a pre-operative fashion range between 45 and 60 Gy over four to seven weeks.

Pathological study of the uterus is difficult after radiotherapy because co-existent tumours cause difficulties in interpretation. In the region of the endometrium, acute necrosis of the glands is identified with haemorrhage and fibrinous exudates. Approximately six weeks after radiotherapy, atrophy, which may

occasionally be severe, as well as atypia in the cells, occurs. Fajardo [23] indicates that lipid containing histiocytes have been described in the endometrium and that ulceration is common, probably as a result of endometrial 'burns' due to the contact of the endometrium with the radium sources. These often heal and are replaced by scar and fibrosis with telangiectasia of the blood vessels in the area. The myometrium does not appear to develop significant fibrosis or atrophy. Changes in arterioles occur, but such changes are often seen in the outer third of the uterine wall (without a radiation exposure history) as patients increase in age. Fajardo [23] suggests that the finding of foamy histiocytes in the endothelial cells with myointimal proliferation should raise the suspicion of radiation treatment.

The cervix has received special attention because of the frequent use of radium therapy for cervical carcinoma. Upon removal of a radium applicator, oedema and exudate often result, lasting for up to three weeks. Atrophy becomes apparent six weeks later, with cervical ulceration being relatively common and healing as described earlier. Actual necrosis of the cervix may occur within one year of therapy; however, in most instances it is due to recurrent tumour. Scarring of the cervix with atrophic epithelium and dysplasia of the epithelium often occur years after the therapy. The dysplasia identified is quite common; whether it represents an in situ carcinoma or a benign situation is uncertain. The actual dose to the cervix is difficult to ascertain because such treatments are usually measured in terms of milligram hours of radium (mgh Ra), and in recent years, ^{137}Ca and ^{192}Ir have been utilized. As a rule of thumb, 1 mgh Ra is equal to 79 mGy.

VAGINA

The vaginal mucosa reacts in a fashion very similar to that of the mucous membrane in other portions of the body, such as the pharynx, including initial stages of moist desquamation, confluent mucositis and occasional ulceration.

The relative sensitivity of the vaginal lining compared with the endometrium is due in large part to the endometrium being composed of reverting post-mitotic cells that are relatively radioresistant, whereas the squamous epithelial lining in the vagina represents proliferating vegetative intermitotic cells that are relatively radiosensitive.

Descriptions of the external genitalia in females after irradiation are difficult to find; however, the tolerance to radiation is low compared with that of most skin, probably because of the effects of moisture and friction. Fractionated doses of 30–50 Gy are capable of eliciting significant desquamative reaction. Vaginal necrosis has been reported in three patients after radiotherapy. All had pre-existing cardiovascular disease and received 70–90 Gy to large portions of the vagina.

PROSTATE AND SEMINAL VESICLES

The prostate and seminal vesicles are quite radioresistant. There is a vast literature derived from the radiotherapy of carcinoma of the rectum, prostate and bladder. On a historical basis, there are several reports of treating benign prostatic hypertrophy with doses in the range of 10–20 Gy. A 30% improvement in the symptomatology of these patients was reported. Current treatment schemes for pelvic carcinoma with external radiation therapy call for fractionated doses totalling 60–70 Gy; this regimen is usually followed without evidence of adverse effects. Very high doses are occasionally achieved through radioactive implants. Ureteral stricture is a rare complication, but fistula formation has been reported.

Fajardo [23] indicates that within weeks of a typical course of external radiotherapy, acute inflammation of the prostate is very uncommon. Within months to years, the parenchyma is reduced in volume, with marked atrophy. Vascular changes may be severe, with myointimal proliferation and foamy cells in the endothelium in a large number of cases. In the region of the seminal vesicles, the perivesicular tissue is replaced by dense collagen.

Chan et al. [41] have used magnetic resonance imaging to study 38 patients treated for prostatic or pelvic tumours. The pattern of signal seen in the prostate was variable, but the most common pattern was a diffuse, low signal intensity on T2 weighted images. The tumour usually has increased signal.

PENIS, URETHRA AND SCROTUM

In general, the penis, urethra and scrotum appear able to tolerate fractionated radiotherapy of 60–65 Gy over six to eight weeks. Treatment for tumours has been performed not only by external radiotherapy but by application of isotope moulds using ^{60}Co and ^{192}Ir . Dose schedules of 20 Gy in 2 days or 50 Gy over 8 days produced severe reactions with late ulceration, probably due to myointimal obliteration. There have been exposures due to industrial radiography sources that have necessitated significant surgical resection or amputation.

Radiotherapy doses in excess of 65 Gy are associated with penile complications including necrosis and urethral stenosis.

Radiation therapy of the prostate with high doses can cause fibrosis and subsequent urinary incontinence. Potency and the ability to maintain a full erection can be reduced after radiotherapy for prostate cancer, but this is most pronounced in men who were only borderline sexually active to begin with or had psychogenic problems. Mittal [42] has studied penile blood flow both before and after prostatic

radiotherapy as well as in individuals who became impotent two to five months post-therapy. There was no measured change in blood flow.

Annex III

DATA ON INDIVIDUAL PATIENTS INVOLVED IN THIS ACCIDENTAL EXPOSURE

<i>Patient No. 1</i> ^a	Male, middle aged
-----------------------------------	-------------------

<i>Tumour history:</i>	Prostate cancer, Gleason grade 1–2, PSA ^b 2.6, nodes negative.
<i>Dates of therapy:</i>	11 Dec. 2000–February 2001; anterior and posterior 16 cm × 16 cm and 8 cm × 16 cm lateral pelvic fields with a total of 15 fractions. Also received four oblique fields in eight fractions.
<i>Estimated dose:</i>	Centre point: 111 Gy, 2 Gy fraction equivalent dose: 140 Gy.
<i>Findings:</i>	Treatment suspended on 26 Dec. 2000 after 12 fractions because of rectal tenesmus and proctitis. Diarrhoea with blood loss continues, uniform skin pigmentation and hyperactive bowel sounds. Minimal urinary symptoms. Has lost about 20 kg.
<i>Conclusions:</i>	Marked effects, at high risk for future effects such as rectal stricture, ulceration and bowel necrosis. (Category of LENT-SOMA: * *)

^a Patient No. corresponds to Table IX.

^b PSA: prostate specific antigen.

<i>Patient No. 2</i>	Male, old
----------------------	-----------

<i>Tumour history:</i>	Prostate cancer, Gleason grade 6, PSA 22, past hormonal treatment. Radiation therapy to both breasts on 4 Mar. 2001.
<i>Dates of therapy:</i>	23 Nov. 2000–9 Feb. 2001; anterior and posterior 16 cm × 16 cm and 8 cm × 16 cm lateral pelvic fields with 20 fractions each.
<i>Estimated dose:</i>	Centre point: 119 Gy, 2 Gy fraction equivalent dose: 162 Gy.
<i>Findings:</i>	First course of radiotherapy stopped on 11 Dec. 2000 because of rectal tenesmus. Rectal bleeding began on 19 Dec. 2000. Diarrhoea occurred constantly from March 2001 to the present. Rectal stenosis. Anaemia requiring transfusions. Urinary frequency three to four hours with reduced volume. 16 kg weight loss. Intense skin pigmentation, pubic epilation.
<i>Conclusions:</i>	Marked effects, at high risk for future effects. (Category of LENT-SOMA: * *)

<i>Patient No. 3</i>	Male, old
<i>Date of death:</i>	20 May 2001, approx. four months after completion of therapy.
<i>Tumour history:</i>	Prostate cancer, no known metastases.
<i>Dates of therapy:</i>	29 Nov. 2000–27 Dec. 2000; anterior and posterior 16 cm × 16 cm and lateral 8 cm × 16 cm fields with 20 fractions each. Arc boost 2 Jan. 2001–16 Jan. 2001.
<i>Estimated dose:</i>	Centre point: 117 Gy, 2 Gy fraction equivalent dose: 171 Gy.
<i>Findings:</i>	After treatment there was malabsorption, 20 kg weight loss. A laparotomy was performed on 18 May 2001 with a caecostomy revealing sigmoid stenosis. Decreased albumin. Haemoglobin: 11.1. Died with 2 cm × 0.7 cm caecal perforation. Autopsy revealed general fibrosis, 12 cm stenosis of the terminal ileum and rectal stenosis with necrosis.
<i>Conclusions:</i>	Death radiation related
<i>Patient No. 4</i>	Male, old
<i>Tumour history:</i>	Rectosigmoid cancer. Prior breast cancer radiotherapy 17 Mar. 2000.
<i>Dates of therapy:</i>	7 Dec. 2000–22 Jan. 2001; anterior and posterior 16 cm × 18 cm and 10 cm × 18 cm pelvic fields with 28 fractions each.
<i>Estimated dose:</i>	Centre point: 100 Gy, 2 Gy fraction equivalent dose: 131 Gy.
<i>Findings:</i>	No current symptoms, mild hyperpigmentation. Rectal bleeding but patient has haemorrhoids.
<i>Conclusions:</i>	No obvious current effects, but high estimated dose suggests patient is at high risk for future effects. (Category of LENT-SOMA: *)
<i>Patient No. 5</i>	Female, old
<i>Date of death:</i>	19 May 2001.
<i>Tumour history:</i>	Endometrial cancer, stage IV.
<i>Dates of therapy:</i>	24 Jan. 2001–2 Mar. 2001; anterior and posterior 14 cm × 16 cm and lateral 9 cm × 16 cm pelvic fields with 25 fractions each.
<i>Estimated dose:</i>	Centre point: 94 Gy, 2 Gy fraction equivalent dose: 127 Gy.
<i>Findings:</i>	Severe diarrhoea, skin desquamation immediately after therapy. Abdominal pain during March 2001. In April 2001, diarrhoea and vaginal discharge began. Died at home.
<i>Conclusions:</i>	Exact cause of death is unknown but with timing and symptoms in the preceding three months, death may well be radiation related.

<i>Patient No. 6</i>	Female, middle aged
----------------------	---------------------

<i>Tumour history:</i>	Cervix, stage IB.
<i>Dates of therapy:</i>	14 Aug. 2000–25 Sep. 2000; anterior and posterior 15 cm × 15 cm pelvic fields and 9 cm × 15 cm lateral fields in 23 fractions. Brachytherapy 24 Oct. 2000.
<i>Estimated dose:</i>	Centre point: 92 Gy, 2 Gy fraction equivalent dose: 122 Gy.
<i>Findings:</i>	After treatment, patient had a hysterectomy on 1 Jan. 2001. Current problem is that the hysterectomy incision has never completely healed and the patient has a 4 cm × 4 cm, 3 cm deep wound.
<i>Conclusions:</i>	Delayed wound healing in treatment field likely related to overexposure. Pedicle graft may be needed. Marked effects, high risk for future radiation effects (Category of LENT-SOMA: * *)

<i>Patient No. 7</i>	Female, old
----------------------	-------------

<i>Date of death:</i>	6 Mar. 2001, about three weeks post-therapy.
<i>Tumour history:</i>	Cervical cancer, stage IIB.
<i>Dates of therapy:</i>	18 Jan. 2001–17 Feb. 2001; anterior and posterior 15 cm × 14 cm pelvic fields and 9 cm × 14 cm lateral fields in 25 fractions.
<i>Estimated dose:</i>	Centre point: 91 Gy, 2 Gy fraction equivalent dose: 121 Gy.
<i>Findings:</i>	Patient had diarrhoea after 13 treatment fractions but continued treatment. At the end of treatment diarrhoea was uncontrollable. Died in another hospital. No autopsy carried out.
<i>Conclusions:</i>	Death is probably radiation related.

<i>Patient No. 8</i>	Male, old
----------------------	-----------

<i>Tumour history:</i>	Prostate cancer, Gleason grade 6, bone scan negative.
<i>Dates of therapy:</i>	21 Nov. 2000–26 Dec. 2000; anterior and posterior 15.5 cm × 15.5 cm pelvic fields and 9 cm × 15.5 cm lateral fields with 23 fractions each. 28 Dec. 2000–12 Jan. 2001; arc boost in ten fractions.
<i>Estimated dose:</i>	Centre point: 96 Gy, 2 Gy fraction equivalent dose: 115 Gy.
<i>Findings:</i>	Mild nausea and diarrhoea after 13 fractions. In May 2001, diarrhoea began again and has continued to be present but decreased. Skin changes are mild to moderate with pigmentation but no significant fibrosis.
<i>Conclusions:</i>	Mild to moderate symptoms now, but at high risk for late effects on bowel due to estimated dose (Category of LENT-SOMA: *)

<i>Patient No. 9</i>	Female, old
----------------------	-------------

<i>Tumour history:</i>	Cervical cancer, stage IIIB.
<i>Dates of therapy:</i>	4 Sept. 2000–13 Oct. 2000; anterior and posterior 15 cm × 15 cm pelvic fields and 9 × 15 cm lateral fields. Additional four smaller oblique fields with 27 fractions.
<i>Estimated dose:</i>	Centre point: 89 Gy, 2 Gy fraction equivalent dose: 110 Gy plus brachytherapy 3410 mg h.
<i>Findings:</i>	Intermittent small bowel obstruction with abdominal bloating. Proctoscopy on 2 May 2001 showed enteritis with ulceration and necrosis of the rectal mucosa 4–5 cm from the anus.
<i>Conclusions:</i>	Severe effects, at high risk for future effects of bowel necrosis, perforation and obstruction (Category of LENT-SOMA: * * *)

<i>Patient No. 10</i>	Female, old
<i>Date of death:</i>	28 Dec. 2000, about ten weeks after completion of teletherapy.
<i>Tumour history:</i>	Cervical cancer, stage IIB; prior breast cancer in 1994 treated with 5 fluorouracil, methotrexate and cyclophosphamide.
<i>Dates of therapy:</i>	4 Sep. 2000–10 Oct. 2000, brachytherapy on 30 Oct. 2000; anterior and posterior 15 cm × 15 cm and 9 cm × 15 cm lateral fields and four oblique fields with 17 fractions each + brachytherapy on 30 Oct. 2000.
<i>Estimated dose:</i>	Centre point: 85 Gy, 2 Gy fraction equivalent dose: 110 Gy.
<i>Findings:</i>	Abdominal distension and diarrhoea began in Nov. 2000. On 1 Dec. 2000 hospitalized with distension nausea, ascites, inhomogeneous liver on ultrasound and lung metastases on chest X ray. Discharged 12 Dec. 2000; patient died at home.
<i>Conclusions:</i>	Death not radiation related but due to metastatic disease.
<i>Patient No. 11</i>	Female, middle aged
<i>Tumour history:</i>	Cervical cancer, stage IB.
<i>Dates of therapy:</i>	5 Sep. 2000–9 Oct. 2000; anterior and posterior 15 cm × 15 cm pelvic fields and 9 cm × 15 cm lateral fields as well as four oblique fields with 25 fractions each.
<i>Estimated dose:</i>	Centre point: 81 Gy, 2 Gy fraction equivalent dose: 108 Gy.
<i>Findings:</i>	Perineal pain, constant diarrhoea with bleeding, anaemia. About 15 kg weight loss. No desire to eat. Possible rectal stenosis.
<i>Conclusions:</i>	Marked effects, high risk due to diarrhoea and high estimated dose. (Category of LENT-SOMA: * *)
<i>Patient No. 12</i>	Female, middle aged
<i>Tumour history:</i>	Cervical cancer, stage IIB.
<i>Dates of therapy:</i>	28 Aug. 2000–6 Oct. 2000; anterior and posterior 14 cm × 15 cm pelvic fields and 8.5 cm × 15 cm (R) and 9.5 cm × 15 cm (L) lateral fields with 20 fractions; brachytherapy and boost.
<i>Estimated dose:</i>	Centre point: 85 Gy, 2 Gy fraction equivalent dose: 103 Gy.
<i>Findings:</i>	Bowel stenosis requiring surgery with small bowel dilation.
<i>Conclusions:</i>	Severe radiation effects and at high risk for later effects. (Category of LENT-SOMA: * * *)

<i>Patient No. 13</i>	Female, middle aged
<i>Tumour history:</i>	Endometrial cancer, stage IV.
<i>Dates of therapy:</i>	5 Nov. 2000–22 Dec. 2000; anterior and posterior 16 cm × 16 cm pelvic fields and 10 cm × 16 cm lateral fields with 25 fractions; brachytherapy with 35 Gy at point A (2800 mg h).
<i>Estimated dose:</i>	Centre point: 82 Gy, 2 Gy fraction equivalent dose: 102 Gy plus brachytherapy.
<i>Findings:</i>	Recently had one episode of bloody diarrhoea but none before. No urinary symptoms. No significant skin changes.
<i>Conclusions:</i>	Minor radiation effects or symptoms at this time but at moderate risk for future effects with the estimated dose. (Category of LENT-SOMA: 0)
<i>Patient No. 14</i>	Female, middle aged
<i>Tumour history:</i>	Cervical cancer, stage IIA.
<i>Dates of therapy:</i>	4 Sep. 2000–10 Oct. 2000; anterior and posterior 15 cm × 15 cm pelvic fields and 9 cm × 15 cm lateral fields as well as four oblique fields with 17 fractions each; brachytherapy 29 Nov. 2000 (2056 mg h).
<i>Estimated dose:</i>	Centre point: 80 Gy, 2 Gy fraction equivalent dose: 100 Gy plus brachytherapy.
<i>Findings:</i>	Diarrhoea since January 2001. Colic pain. No urinary symptoms. Minimal skin changes.
<i>Conclusions:</i>	Mild effects now but at high risk for late bowel effects due to estimated dose level. (Category of LENT-SOMA: *)
<i>Patient No. 15</i>	Female, old
<i>Tumour history:</i>	Endometrial cancer, stage IC.
<i>Dates of therapy:</i>	23 Aug. 2000–10 Oct. 2000.
<i>Estimated dose:</i>	Centre point: 80 Gy, 2 Gy fraction equivalent dose: 99 Gy.
<i>Findings:</i>	During treatment had dysuria and tenesmus but no bleeding. In March 2001 vaginal vault was 90% sealed with petechiae present. Currently with rectal bleeding, dysuria and occasional constipation.
<i>Conclusions:</i>	Moderate effects presently but at high risk for severe late bowel effects with the estimated dose. (Category of LENT-SOMA: *)

<i>Patient No. 16</i>	Female, middle aged
-----------------------	---------------------

<i>Tumour history:</i>	Endometrial cancer, stage I.
<i>Dates of therapy:</i>	29 Aug. 2000–5 Oct. 2000; anterior and posterior 15 cm × 15 cm and 9 cm × 15 cm lateral pelvic fields with 18 fractions each. Also received four smaller oblique fields with 7 fractions each; brachytherapy 20 Nov. 2000 (2056 mg h).
<i>Estimated dose:</i>	Centre point: 77 Gy, 2 Gy fraction equivalent dose: 94 Gy plus brachytherapy.
<i>Findings:</i>	Lower abdominal colicky pain. Mucous per rectum. Urinary symptoms of low volume and frequency. No diarrhoea currently.
<i>Conclusions:</i>	Mild bowel symptoms currently. At moderate risk for severe late bowel effects with estimated dose. (Category of LENT-SOMA: *)

<i>Patient No. 17</i>	Female, old
-----------------------	-------------

<i>Tumour history:</i>	Mullerian sarcoma.
<i>Dates of therapy:</i>	16 Nov. 2000–28 Dec. 2000; anterior and posterior 16 cm × 15 cm and 8 cm × 15 cm lateral pelvic fields with 25 fractions each. Brachytherapy in Feb. 2001.
<i>Estimated dose:</i>	Centre point: 79 Gy, 2 Gy fraction equivalent dose: 98 Gy plus brachytherapy.
<i>Findings:</i>	Mild weight loss, vaginal and bladder prolapse. Malaise and abdominal pain. Persistent diarrhoea with bleeding. Anterior fibrosis.
<i>Conclusions:</i>	Marked effects, at high risk for future severe bowel effects. (Category of LENT-SOMA: * *)

<i>Patient No. 18</i>	Male, old
-----------------------	-----------

<i>Tumour history:</i>	Rectal adenocarcinoma with prior chemotherapy.
<i>Dates of therapy:</i>	30 Aug. 2000–6 Oct. 2000; anterior and posterior 14 cm × 20 cm and 10 cm × 20 cm lateral pelvic fields with 25 fractions each. Boost with five fractions but no documentation.
<i>Estimated dose:</i>	Centre point: 81 Gy, 2 Gy fraction equivalent dose: 93 Gy.
<i>Findings:</i>	In April 2001 diarrhoea began and patient must wear diapers. Occasional bleeding but not currently. Fibrosis with hyper- and depigmentation anteriorly and posteriorly. Rectal cancer still present by proctoscopy.
<i>Conclusions:</i>	Marked radiation effects causing symptoms. At high risk for future bowel effects. (Category of LENT-SOMA: * *)

<i>Patient No. 19</i>	Female, middle aged
-----------------------	---------------------

<i>Tumour history:</i>	Vaginal cancer, squamous cell, stage II.
<i>Dates of therapy:</i>	5 Sep. 2000–10 Oct. 2000; anterior and posterior 14 cm × 14 cm and 8 cm × 14 cm lateral fields with 23 fractions each. Treatment times 1.0, 1.0, 1.0 and 0.74 min.
<i>Estimated dose:</i>	Centre point: 74 Gy, 2 Gy fraction equivalent dose: 92 Gy. Also had additional caesium brachytherapy (2740 mg h).
<i>Findings:</i>	Hysterectomy in 1992 for carcinoma in situ. Bloody diarrhoea since Sep. 2000 requiring transfusions. Urinary frequency with some haematuria. Haemoglobin on 24 May was 9.5. Currently anorexic. Minimal skin changes.
<i>Conclusions:</i>	Marked effects now and at high risk for future effects. (Category of LENT-SOMA: * *)

<i>Patient No. 20</i>	Female, middle aged
<i>Date of death:</i>	7 May 2001.
<i>Tumour history:</i>	Cervical cancer, stage IB.
<i>Dates of therapy:</i>	10–29 Jan. 2001; anterior and posterior 15 cm × 16 cm and 9 cm × 16 cm lateral pelvic fields with 13 fractions each. Treatment times 1.4, 1.4, 1.7, 1.7 min.
<i>Estimated dose:</i>	Centre point: 58 Gy, 2 Gy fraction equivalent dose: 88 Gy.
<i>Findings:</i>	Hysterectomy 5 September 2000. Radiation treatment during January but had to be stopped because of severe reactions. 30 Jan. 2001 admitted to hospital with weakness, nausea, subacute bowel obstruction and diarrhoea. Readmitted on 29 March 2001 with enteritis. Readmitted 17 April 2001 with Klebsiella sepsis, bloody diarrhoea and diffuse intravascular coagulopathy. Operated upon on 24 April; died in hospital.
<i>Conclusions:</i>	Death radiation related.
<i>Patient No. 21</i>	Female, middle aged
<i>Date of death:</i>	15 Dec. 2000.
<i>Tumour history:</i>	Cervical cancer, stage IIIB.
<i>Dates of therapy:</i>	16 Aug. 2000–9 Sep. 2000 (partial treatment only), 21 fractions.
<i>Estimated dose:</i>	Centre point: 68 Gy, 2 Gy fraction equivalent dose: 84 Gy.
<i>Findings:</i>	Expired. No data available.
<i>Conclusions:</i>	Died, cause unknown.
<i>Patient No. 22</i>	Female, old
<i>Date of death:</i>	28 March 2001.
<i>Tumour history:</i>	Cervical cancer, stage IIB.
<i>Dates of therapy:</i>	8 Jan. 2001–9 Feb. 2001. Anterior and posterior 15 cm × 15 cm and 10 cm × 15 cm lateral pelvic fields with 16 fractions each.
<i>Estimated dose:</i>	Centre point: 61 Gy, 2 Gy fraction equivalent dose: 84 Gy.
<i>Findings:</i>	Radiation treatment had to be suspended after 16 treatments because of dehydration and diarrhoea. Anaemia and continuous diarrhoea during February and March 2001. In March, the total albumin was 0.9, BUN 35 and creatinine 2.1. Patient developed renal insufficiency and hyperkalemia and died in hospital.
<i>Conclusions:</i>	Death assumed to be radiation related.

<i>Patient No. 23</i>	Female, old
-----------------------	-------------

<i>Tumour history:</i>	Endometrial cancer, stage T2.
<i>Dates of therapy:</i>	28 Aug. 2000–4 Oct. 2000; anterior and posterior 14 cm × 16 cm and 8.5 cm × 16 cm lateral pelvic fields with 14 fractions each. Four oblique fields as well, with 11 fractions. Caesium brachytherapy planned but not given.
<i>Estimated dose:</i>	Centre point: 69 Gy, 2 Gy fraction equivalent dose: 89 Gy.
<i>Findings:</i>	Diarrhoea and occasional bleeding during therapy. Insulin dependent diabetic. Occasional vomiting since February. No diarrhoea or bladder symptoms presently.
<i>Conclusions:</i>	No current severe effects. Minimal skin changes. Diabetes may predispose patient to higher than expected risk of future effects. (Category of LENT-SOMA: *)

<i>Patient No. 24</i>	Female, old
-----------------------	-------------

<i>Date of death:</i>	19 Oct. 2000, approximately two weeks post-radiation therapy.
<i>Tumour history:</i>	Endometrial cancer, stage IIIB. Hysterectomy 21 July 2000.
<i>Dates of therapy:</i>	4 Sep. 2000–5 Oct. 2000; anterior and posterior 15 cm × 15 cm and 9 cm × 15 cm lateral pelvic fields in 11 fractions. Four oblique fields in seven fractions terminated early.
<i>Estimated dose:</i>	Centre point: 58 Gy, 2 Gy fraction equivalent dose: 73 Gy. Anterior and posterior 15 cm × 15 cm and 9 cm × 15 cm lateral pelvic fields in 11 fractions. There were four additional oblique pelvic fields with 7 fractions each. No brachytherapy.
<i>Findings:</i>	Treatment terminated due to nausea, vomiting and diarrhoea. Hospitalized on 17 October with hypotension, anasarca, creatinine of 2.8, haemoglobin 10, platelets 39 000, white blood cells 3900. Expired in hospital two days later.
<i>Conclusions:</i>	No autopsy carried out. With limited data and high stage tumour, it is unknown if the death was radiation related.

<i>Patient No. 25</i>	Female, middle-aged
-----------------------	---------------------

<i>Tumour history:</i>	Cervical cancer, stage IIB.
<i>Dates of therapy:</i>	30 Nov. 2000–28 Dec. 2000; anterior and posterior 16 cm × 16 cm and 8 cm × 16 cm lateral pelvic fields with 18 fractions each.
<i>Estimated dose:</i>	Centre point: 47 Gy, 2 Gy fraction dose equivalent: 53 Gy.
<i>Findings:</i>	Treatment interrupted for personal reasons. Currently no symptoms.
<i>Conclusions:</i>	No excess risk likely as a result of the accidental exposure. May have normal post-treatment incidence of complications. (Category of LENT-SOMA: 0)

<i>Patient No. 26</i>	Male, old
-----------------------	-----------

<i>Tumour history:</i>	Prostate cancer diagnosed in 1995. Hormonal therapy, but biopsy in 2000 was positive and there was hydronephrosis. PSA>700.
<i>Dates of therapy:</i>	2–20 Feb. 2001; anterior and posterior 15 cm × 15 cm and 9 cm × 15 cm lateral pelvic fields with 15 fractions each.
<i>Estimated dose:</i>	Centre point: 55 Gy, 2 Gy fraction equivalent dose: 73 Gy.
<i>Findings:</i>	Patient did not complete the 25 treatments because he refused to return after 17 fractions due to colicky pain and rectal bleeding. The bleeding continued for three weeks post-therapy. Now with no diarrhoea but mild lower abdominal pain and urinary frequency. The skin showed mild pigmentation anteriorly and some depigmentation posteriorly. Mild pubic epilation.
<i>Conclusions:</i>	Low risk for effects from the accidental exposure. Still at risk for expected incidence of late complications that might be expected from standard radiotherapy. (Category of LENT-SOMA: *)

<i>Patient No. 27</i>	Male, old
-----------------------	-----------

<i>Tumour history:</i>	Prostate cancer, Gleason grade 5, PSA 12.5.
<i>Dates of therapy:</i>	5 Feb. 2001–2 Mar. 2001; anterior and posterior 15 cm × 15 cm and 10 cm × 15 cm lateral pelvic fields with 17 fractions each. Originally 25 fractions planned.
<i>Estimated dose:</i>	Centre point: 54 Gy, 2 Gy fraction equivalent dose: 67 Gy.
<i>Findings:</i>	Patient terminated treatment because of severe diarrhoea as well as bladder and rectal tenesmus. Now with occasional bloating and intermittent diarrhoea. No urinary complaints. CT scan on 11 May 2001 showed thickened wall of the bladder and rectosigmoid. Recent endoscopy showed some necrosis of all of the right colon. Colonoscopy scheduled.
<i>Conclusions:</i>	Higher than normal risk because of early symptoms and bowel findings on CT scan and endoscopy. (Category of LENT-SOMA: *)

<i>Patient No. 28</i>	Male, old
-----------------------	-----------

<i>Tumour history:</i>	Prostate cancer, Gleason grade 5, PSA 9.5. Prior hormone treatment.
<i>Dates of therapy:</i>	16–29 Nov. 2000. Patient had six treatments and went for personal reasons to another hospital to complete therapy.
<i>Estimated dose:</i>	Centre point: 19 Gy, 2 Gy fraction equivalent dose: 25 Gy. Anterior and posterior 16 cm × 17 cm and 9 cm × 17 cm lateral pelvic fields with six fractions each. Total dose is not known since therapy records from the second hospital were not available.
<i>Findings:</i>	After the 16th treatment patient had vomiting and diarrhoea for three weeks. Now with occasional diarrhoea depending upon diet. No urinary symptoms at present. Posterior pigmentation with small areas of depigmentation. No fibrosis.
<i>Conclusions:</i>	Low risk for effects from the accidental exposure. Still at slightly higher than the normal incidence of expected side effects since total dose was probably slightly higher than planned.

REFERENCES

- [1] FOOD AND AGRICULTURE ORGANIZATION OF THE UNITED NATIONS, INTERNATIONAL ATOMIC ENERGY AGENCY, INTERNATIONAL LABOUR ORGANISATION, OECD NUCLEAR ENERGY AGENCY, PAN AMERICAN HEALTH ORGANIZATION, WORLD HEALTH ORGANIZATION, International Basic Safety Standards for Protection against Ionizing Radiation and for the Safety of Radiation Sources, Safety Series No. 115, IAEA, Vienna (1996).
- [2] INTERNATIONAL ATOMIC ENERGY AGENCY, Accidental Overexposure of Radiotherapy Patients in San José, Costa Rica, IAEA, Vienna (1998).
- [3] INTERNATIONAL ATOMIC ENERGY AGENCY, Lessons Learned from Accidental Exposure in Radiotherapy, Safety Reports Series No. 17, IAEA, Vienna (1999).
- [4] FLETCHER, G.H. (Ed.), Textbook of Radiotherapy, Lea & Febiger, Philadelphia (1980).
- [5] PÉREZ, C.A., BRADY, L.W. (Eds), Principles and Practices of Radiation Oncology, J.B. Lippincott, Philadelphia (1992).
- [6] ORGANISMO INTERNACIONAL DE ENERGÍA ATÓMICA, Aspectos Físicos de la Garantía de Calidad en Radioterapia: Protocolo de control de Calidad, IAEA-TECDOC-1151, IAEA, Vienna (2000).
- [7] IZEWSKA, J., ANDREO, P., The IAEA/WHO TLD postal programme for radiotherapy hospitals, *Radiother. Oncol.* **54** (2000) 65–72.
- [8] UNIDAD TÉCNICA DE PROTECCIÓN RADIOLÓGICA: DEPARTAMENTO DE SALUD RADIOLÓGICA, MINISTERIO DE SALUD, Informe técnico: Accidente radiológico, Instituto Oncológico Nacional, Panamá, Informe del 25 Mayo 2001.
- [9] PAN AMERICAN HEALTH ORGANIZATION, Letter from PAHO regional office in Washington to PAHO representative in Panama, 24 March 2001.
- [10] PAN AMERICAN HEALTH ORGANIZATION, Letter from PAHO regional office in Washington to PAHO representative in Panama, 16 April 2001.
- [11] AGUIRRE, A., ALMOND, P., LINDBERG, R., Report of a consultation visit to the National Oncology Center, Panama City, 17–18 April 2001.
- [12] INTERNATIONAL ATOMIC ENERGY AGENCY, Standardized Quality Audit Procedures for On-Site Visits to Radiotherapy Hospitals, Internal Rep. IAEA-DMRP-199907-IU, IAEA, Vienna (1999).
- [13] INTERNATIONAL ATOMIC ENERGY AGENCY, Design and Implementation of a Radiotherapy Programme: Clinical, Medical Physics and Radiation Protection and Safety Aspects, IAEA-TECDOC-1040, IAEA, Vienna (1998).
- [14] INTERNATIONAL ATOMIC ENERGY AGENCY, Absorbed Dose Determination in Photon and Electron Beams: An International Code of Practice, 2nd edn, Technical Reports Series No. 277, IAEA, Vienna (1997).
- [15] BRITISH INSTITUTE OF RADIOLOGY, Central Axis Depth Data for Use in Radiotherapy, Joint Working Party of the British Institute of Radiology and the Institution of Physics and Engineering in Medicine and Biology, BJR Supplement 25 (1996).
- [16] MULTIDATA SYSTEMS INTERNATIONAL CORP., RTP/2 User and Reference Guide, Release 2.1 & Up, St. Louis, MO.

- [17] STEEL, G.G., ARNOLD, E., (Eds.), *Basic Clinical Radiobiology*, Arnold, London (1993).
- [18] DALRYMPLE, G.V., et al., *Medical Radiation Biology*, W.B. Saunders, Philadelphia, PA, (1973), Table 1-13 (p. 23).
- [19] SCHERER, E., STREFFER C., TROTT, K., *Radiopathology of Organs and Tissues*, Springer-Verlag, Berlin (1991).
- [20] RUBIN, P., CASARETT, G.W., *Clinical Radiation Pathology*, W.B. Saunders, Philadelphia, PA (1968).
- [21] AMERICAN ASSOCIATION OF PHYSICISTS IN MEDICINE. *Comprehensive QA for Radiation Oncology*. Rep. AAPMTG-40, *Med. Phys.* **21** (1994) 1–38.
- [22] KESTELOOT, K., DUTREIX, A., VAN DER SCHUEREN, E., A model for calculating the costs of in vivo dosimetry and portal imaging in radiotherapy departments., *Radiother. Oncol.* **28** (1993) 108–117.
- [25] LIFSHITZ, S., SAVAGE, J.E., TAYLOR, K.A., Plasma prostaglandin levels in radiation-induced enteritis, *Int. J. Radiat. Oncol. Biol. Phys.* **8** (1982) 275–277.
- [26] HENRIKSSON, R., FRANZEN, L., LITTBRAND, B., Effects of sucralfate on acute and late bowel discomfort following radiotherapy of pelvic cancer, *J. Clin. Oncol.* **10**, (1992) 969–975.
- [27] LENTZ, S., SCHRAY, M., WILSON, T., Chylous ascites after whole abdomen irradiation for gynecologic malignancy, *Int. J. Radiat. Oncol. Biol. Phys.* **19** (1990) 435–438.
- [28] PERKINS, D.E., SPJUT, H.J., Intestinal stenosis following radiation therapy, *Am. J. Radiol.* **88** (1962) 953.
- [29] DONALDSON, S., JUNDT, S., RICOUR, C., et al., Radiation enteritis in children. *Cancer* **35** (1975) 1167–1178.
- [30] COIA, L., HANKS, G., Compications from large field intermediate dose infradiaphragmatic radiation: An analysis of the patterns of care outcome studies or Hodgkin's disease and seminoma, *Int. J. Radiat. Oncol. Biol. Phys.* **15** (1988) 29–35.
- [31] GEHRIG, J., HACKI, W., SCHULTHESS, H., et al., Strahlenproktitis nach Gynaekologischer Radiotherapie: Eine endoskopische Studie, *Schweiz. Med. Wochenschr.* **117** (1987) 1326–1332.
- [32] CHAU, P.M., et al., Complications in high dose pelvis irradiation in female pelvic cancer, *Am. J. Radiol.* **87** (1962) 22–40.
- [33] SCHMITZ, H., Complications of the urinary tract due to carcinoma of the cervix or radiation treatment, *Am. J. Raiol.* **24** (1930) 47.
- [34] MONTANA, G., FOWLER, W., Carcinoma of the cervix: Analysis of bladder and rectal radiation dose and complications, *Int. J. Radiat. Oncol. Biol. Phys.* **16** (1989) 95–100.
- [35] GOODMAN, M., DALTON, J.R., Ureteral structures following radiotherapy: Incidence, etiology and treatment guidelines, *J. Urol.* **128** (1982) 21–24.
- [36] PARLIAMENT, M., et al., Obstructive ureteropathy following radiation therapy for carcinoma of the cervix, *Gynecol. Oncol.* **33** (1989) 237–240.
- [37] BEHR, J., WINKLER, M., WILLGEROTH, F., Functional changes of the lower urinary tract after irradiation of cervical carcinoma, *Strahlenther. Onkol.* **166** (1990) 135–139.

- [38] LAWTON, C., et al., Long term treatment sequel following external beam irradiation for adenocarcinoma of the prostate. Analysis of RTOG studies 7506 and 7706, *Int. J. Radiat. Oncol. Biol. Phys.* **21** (1991) 935–939.
- [39] DOLL, R., SMITH, P.G., The long-term effects of X irradiation in patients treated for metropathia haemorrhagica, *Br. J. Radiol.* **41** (1968) 362–368.
- [40] HAMBERGER, A.D., et al., Analysis of severe complications of irradiation of carcinoma of the cervix: Whole pelvic irradiation and intracavitary radium, *Int. J. Radiat. Oncol. Biol. Phys.* **9** (1983) 367–371.
- [41] CHAN, T., KRESSEL, H., Prostrate and seminal vesicles after irradiation: MR appearance, *J. Magn. Res. Imag.* **1** (1991) 503–511.
- [42] MITTAL, B., A study of penile circulation before and after radiation in patients with prostate cancer and its effect on impotence, *Int. J. Radiat. Oncol. Biol. Phys.* **11** (1985) 1121–1125.

CONTRIBUTORS TO DRAFTING AND REVIEW

Akashi, M.	Research Center for Radiation Emergency Medicine of the National Institute of Radiological Sciences, Japan
Borrás, C.	Pan American Health Organization
Cosset, J.-M.	Département de Radiothérapie, Institut Curie, France
Gibbs, E.	Departamento de Salud Radiológica, Panama
Gourmelon, P.	Centre d'Etudes Nucléaires, Institut de Protection et de Sûreté Nucléaire, France
Izewska, J.	International Atomic Energy Agency
Konchalovsky, M.V. (<i>representing WHO</i>)	Hematologic Department of the Scientific Research Center of Russia, Russian Federation
Mettler, F.A., Jr.	Department of Radiology, The University of New Mexico, School of Medicine, USA
Miles, J.	National Radiological Protection Board, United Kingdom
Morales, E.	Dirección General de Salud, Panama
Nogueira, C.	International Atomic Energy Agency
Oresegun, M.	International Atomic Energy Agency
Ortiz López, P.	International Atomic Energy Agency
Rudder, D.	Consultant to the Pan American Health Organization
Vatnitsky, S.	International Atomic Energy Agency
Wrixon, A.D.	International Atomic Energy Agency